

STOCK MEMBRANE SWITCHES

World's
Leading
Source

 **XYMOX**[®]
TECHNOLOGIES, INC.

PROVIDING TOTAL CUSTOMER SATISFACTION IN INTERFACE TECHNOLOGY PRODUCTS SINCE 1979

Xymox Technologies, Inc. is a leading source for stock and custom designed membrane switches. The membrane switches shown in this catalog represent the largest selection of stock membrane switches available anywhere in the world. We were pioneers in the development of membrane switch technology and still lead in research and development of new designs, advanced manufacturing techniques and testing procedures. We are expanding our product offering with value-added design and assembly of total Integrated Membrane Switch Modules (IMSM) that include backing panels, PCB assemblies, electronic displays, custom designed enclosures and elastomer assemblies. Our experienced and highly skilled team is dedicated to providing products and services that exceed our customers' expectations.

We are committed to:

- **Total customer satisfaction**
- **Highest standards of quality**
- **Continual product improvement**
- **Short lead times**
- **On-time delivery**
- **Technical excellence**
- **Competitive pricing**

TABLE OF CONTENTS

| | |
|--|----------------|
| General application data | 3, 4, 5 |
| 5/8" center-to-center keypads..... | 6, 7, 8 |
| 3/4" center-to-center edge-abutable switch strips | 9, 10, 11 |
| 3/4" center-to-center edge-abutable keypads..... | 12, 13, 14, 15 |
| 3/4" center-to-center keypads..... | 16, 17 |
| 3/4" center-to-center keyboards | 18, 19 |
| 1" center-to-center edge-abutable keypads..... | 20, 21 |
| Discrete switches..... | 22 |
| 1 1/4" center-to-center edge-abutable switch strips | 22 |
| General application data: | |
| Tactile feedback switches | 23, 24 |
| Stock metal domes | 25 |
| 3/4" center-to-center tactile feedback keypads | 26, 27 |
| 3/4" center-to-center tactile feedback keyboards..... | 28, 29 |
| 3/4" center-to-center edge-abutable tactile feedback switch strips | 30 |
| 3/4" center-to-center edge-abutable tactile feedback keypads..... | 31, 32, 33 |

ORDER AND PRICE INFORMATION

All Xymox stock membrane switches are available off-the-shelf from Xymox authorized distributors. Pricing information is available on a separate price sheet.

THE XYMOX STOCK MEMBRANE SWITCH

The Xymox stock membrane switch is a normally open, momentary contact, push button type device. Layers of insulating materials, conductive coatings and adhesives are combined to form a completely sealed switch ideally suited for switching low energy logic signals.

Multiple contacts and inter-connections are employed to provide complex switching networks which are reliable and cost effective.

All stock product Xymox panels are constructed of flexible materials and are designed to be bonded to a rigid support surface. Connections are made through conductive tracks on a connecting tail. Various styles of tail terminations are available.

ADVANTAGES OF XYMOX STOCK SWITCHES

Availability - Stocked locally through a worldwide network of Xymox distributors.

Economy - Stock switches (without faceplates) carry no art, plate or set-up charges.

Reliability - Proven through extensive testing and years of customer use.

Perpendicular tail - Prevents airborne contaminants and liquid splashes from entering your electronics cabinet at the edge of the switch.

Edge-abutable - In some models, various, continuous spacing switch configurations can be made by placing any of the non-tailed sides of the switches edge-to-edge.

Variety of tail termination methods - Compatible with many connectors.

Matrix of common bus - Provides flexibility for your electronic design.

Compatible with custom faceplates - Custom appearance is achieved by mounting one or more switches behind the custom faceplate of your design.

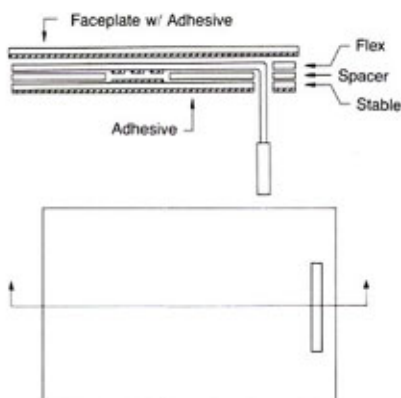
Perpendicular Tail

Xymox membrane switches can be designed with a complete seal to the housing which eliminates potential leak paths. Using a patented construction, the tail travels from the top switching layer and through the two bottom layers of the switch and breaks out of the back of the keypad - not off the edge - and a complete adhesive perimeter seal is maintained. While not intended for immersion, liquid splashes, as well as dust and other airborne contaminants, are prevented from ever entering the housing via the switch. Switch contact and circuitry are protected from the environmental hazards which keyboard surfaces normally encounter.

* U.S. patent nos. 4,217,473 and 4, 218,600

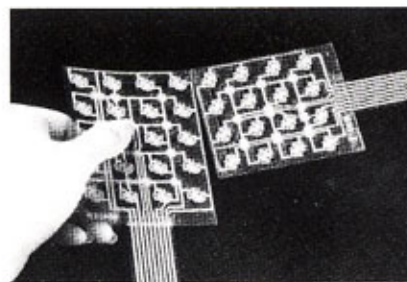
EDGE-ABUTTABLE SWITCHES

The Xymox edge-abutable switch line enables designers to abut any two or more switches while maintaining continuous center-to-center key spacings. For example, two switches, a 4x5 (20 key) keypad and a 4x4 (16 key) keypad can be placed edge-to-edge to make up a continuously spread 4x9 (36 key) keypad. The switches are edge-abutable on all three non-tailed sides. Turning the 4x5 (20 key) keypad 90° creates a completely different switch arrangement (see photo above).

Edge-abutable switches make it easy for a designer to incorporate stock switches into new products requiring membrane switches because of the hundreds of continuous spacing configurations that can be made from the large selection of edge-abutable switches offered in this catalog.

TAIL TERMINATION METHODS

Without connector - Stock switches are provided with holes punched in the end of the tail which makes the tail suitable for use with a Burndy HBLB...R5, S5 or equivalent, or a Molex series 4850 connector. Part numbers ending in "2" have no connector applied.

With connector - Xymox supplies switches terminated with factory installed Berg series 65801 female connectors. These connectors can plug on 0.025" square posts on 0.10" centers. Other forms of connectors may also be compatible with Xymox switches. Part numbers ending in "4" have connectors applied. Tails terminated with factory installed solder tabs or T&B Ansley FP series female connectors may be requested as a custom feature.

Matrix or common bus options - Many of the Xymox stock keypads that are less than 20 keys are offered in both matrix and common bus configurations. This feature offers the user flexibility in electronic design. Choose the one that best fits your electronics requirements. If you have difficulty determining which is best for your application, our staff of application engineers would be happy to assist you in meeting your requirements.

STOCK SWITCHES ARE COMPATIBLE WITH CUSTOM FACEPLATES

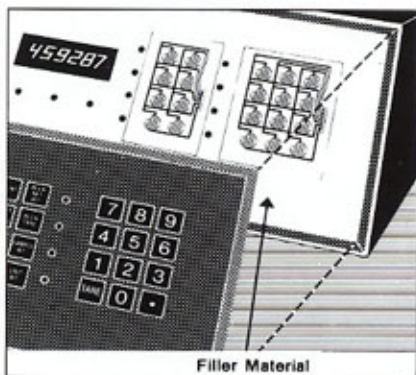

Filler material - One or more stock keypads can be mounted behind a custom faceplate, giving the appearance of a completely custom switching package. Using stock switches with a custom faceplate eliminates the need for art, plate and set up charges on the switch portion of the package.

The custom faceplate is produced with a .020" thick filler material mounted to its back side. The filler material has die cut areas where the .020" thick switches are inserted, making the entire switching package a uniform thickness. The entire switching package can be ordered from distribution as a completely assembled unit ready for installation, or component switches, faceplates and filler materials can be ordered separately. The illustration above shows the switches, filler material and faceplates as separate components mounted to a housing. Adhesive-backed, 0.020" thick, polycarbonate filler material is available in 19"x22" sheets. Order by catalog # 2032110.

BACKLIGHTING

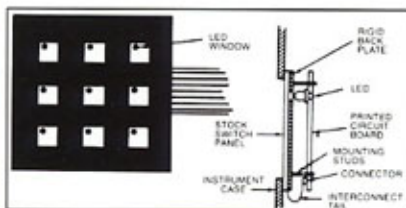

Transparent LED areas are provided in switch strip and keypad component units. They can be used with custom faceplates having LED windows in the keys as shown below.

TACTILE FEEDBACK

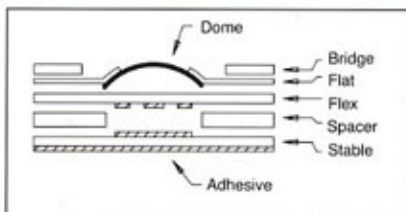

Xymox tactile feedback metal dome switches are ideally suited for use in most membrane switching applications where user feedback is required. They are constructed with stainless steel domes located over each switch location. A large variety of Xymox stock keypads are available off-the-shelf with mounted metal domes. These stainless steel snap domes are independent of any electrical contact. This ensures that the long life of the electrical contact is not affected by mechanical parts.

ADHESIVE

Stock membrane switch panels are furnished with 3M Stamark adhesive. This is an acrylic based, general purpose adhesive that provides good tack and excellent ultimate bond on most surfaces.

ELECTRICAL CHARACTERISTICS

- Contact rating:** 30VDC Max.
100mA Max.....1 watt Max.
- Contact resistance:** Resistance varies proportionately with part size - typically 100 Ohms or less through the life of the switch.
- Open circuit resistance:** Greater than 10⁶ Ohms minimum.
- Contact bounce:** Less than 1 millisecond nominal. 10 milliseconds maximum.
- Contact material:** Silver to silver.
- Life:** Tested to over 5 million operations at 30 VDC - 33mA and at 10 VDC - 100mA.
- Dielectric strength:** Polyester switch layers - 15,000 V.

PHYSICAL CHARACTERISTICS

- Operating Force:**
- Tactile:** 8-10 oz. typical (switch only).
10-14 oz. typical with faceplate installed.
- Non-tactile:** 2-4 oz. typical (switch only).
4-8 oz. typical with faceplate installed.
Non-circular keys may be lower.
- Switch travel:** .006" or .008" typical.
- Operating temperatures:** -34°C to +65°C
(-30°F to 149°F).
- Storage temperatures:** -40°C to +65°C
(-40°F to 149°F).
- Thermal shock:** No effect after 100 cycles, each consisting of 30 minutes at -40°C and 30 minutes at 85°C.
- Humidity:** No effect after exposure to 95% relative humidity at 40°C for 21 days.
- Termination:** Flexible tail with contact tracks on 0.100" centers.
- Thickness:**
- Tactile:** Approximately .040" to top of dome. Approximately .024" to top of bridge layer. Measured without faceplate.
- Non-Tactile:** .020" typical. Measured without faceplate.

| Property | Test Method | Performance Standard | Comments |
|------------------------------------|---|---|--|
| 1. Contact Resistance | MIL-STD-202F, Method 307 | Less than 100 Ohms | Measured from termination area on tail, switch closed |
| 2. Insulation Resistance | MIL-STD-202F, Method 302 Test Condition B (500 Volts) | Greater than 10 ⁹ Ohms for 60 seconds | All switches in parallel |
| 3. Dielectric Withstanding Voltage | MIL-STD-202F, Method 301 | 500 VAC, 60 Seconds. No Breakdown | All switches in parallel |
| 4. Capacitance | MIL-STD-202F, Method 305 (1KHz) | Less than 20 pfd | Measured between adjacent tracks |
| 5. Intermediate Current Switching | MIL-STD-202F, Method 312 25°C only | Contact bounce less than 10 milliseconds after 5x10 ⁶ cycles | 4-8 oz. actuation force, 3Hz, 50% duty cycle |
| 6. Conductive Material Adhesion | ASTM D3359-78, Method B (adhesive tape pull test) | Classification 5 | Run on 1" wide test sample |
| 7. Flexibility | ASTM D2861-78, Sections 20-24 (inside and outside bends over 0.25" diameter for 2" length, 16 tracks tested at once) | 500 cycles with less than 10x increase in resistance (2x typical) | 10 cpm, performance calculated back to less than 10x change per switch circuit over 0.125" radius bend |
| 8. Humidity (Steady State) | MIL-STD-202F, Method 103B, Test Condition C (504 hrs. at 40°C, 95% RH) | Insulation resistance greater than 10 ⁹ Ohms after 24 hours at ambient | 15 VDC applied to all switches in parallel during test |
| 9. Moisture Resistance | MIL-STD-202F, Method 106E except Step 7B (10 cycles lasting 24 hrs. per cycle of 65°C, 25°C, -10°C at 95% RH, -10°C only 5 cycles with no RH control) | Insulation resistance greater than 10 ⁹ Ohms after 24 hours at ambient | 15 VDC applied to all switches in parallel during steps specified |
| 10. Thermal Shock | MIL-STD-202F, Method 107D, Test Condition A-3 (100 cycles of -40°C to 85°C) | See Note 1 | 0.5 hr. per exposure -40°C instead of -55°C, 85°C instead of 65°C |
| 11. Life (at elevated temperature) | MIL-STD-202F, Method 108A, Test Condition C, 70°C (500 hrs. at 70°C no RH control) | See Note 1 | 15 VDC applied to all switches in parallel during test |
| 12. Vibration | MIL-STD-202F, Method 204D, Test Condition C (55 to 2000 Hz 10g peak) | No closures during test or visual effect | 15 VDC applied to all switches in parallel during test |
| 13. Shock (Specified Pulse) | MIL-STD-202F, Method 213B, Test Condition C (half-sine wave, 6ms duration, 100g maximum.) | No closures during test or visual effect | 15 VDC applied to all switches in parallel during test |

Note 1 - Initial and Final Tests shall include:

A. Insulation Resistance - Initial greater than 10⁹ Ohms. Final minimum of 10⁹ Ohms.

B. Contact Resistance - Initial and Final 100 Ohms or less.

C. Actuation Force - Initial and Final 4-8 oz.

5/8" center to center keypads are ideally suited for use where closer than normal center to center spacings are required.

Dimensions Shown: Inches

All Dimensions: $\pm 0.015"$

TAIL BREAKOUT

Shown is the recommended mounting surface slot detail for these stock products.

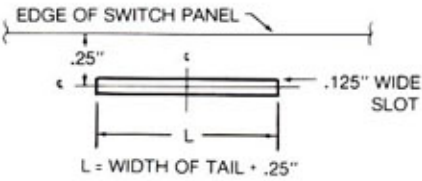

DETAIL of individual switch position



- Outside Diameter = .500"
- Pad diameter = .400"
- LED window dia. = .125"

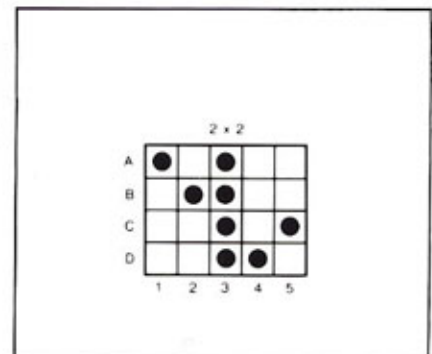
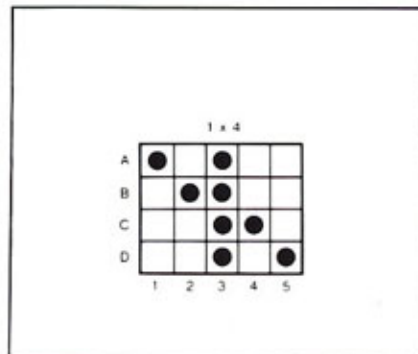
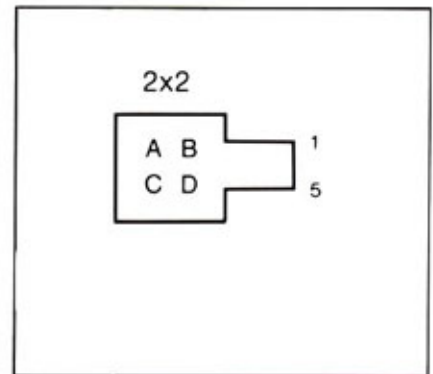
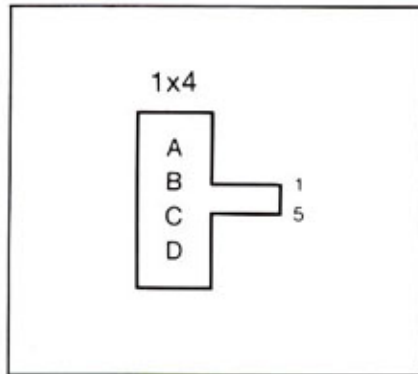
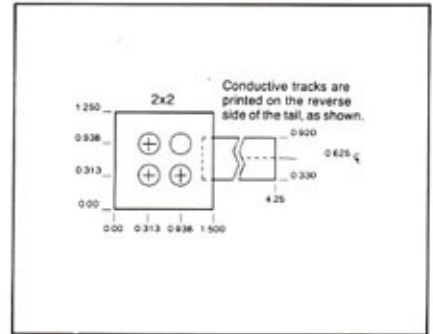
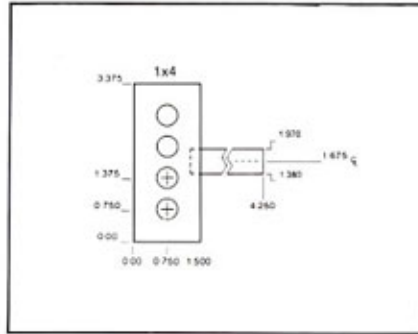

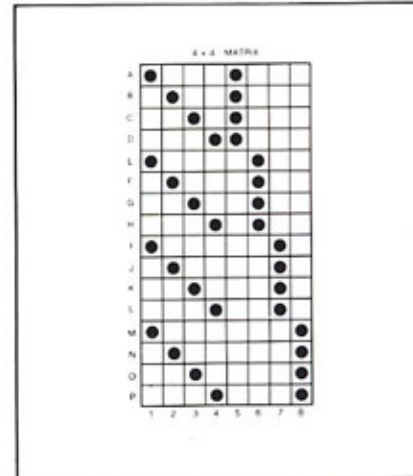
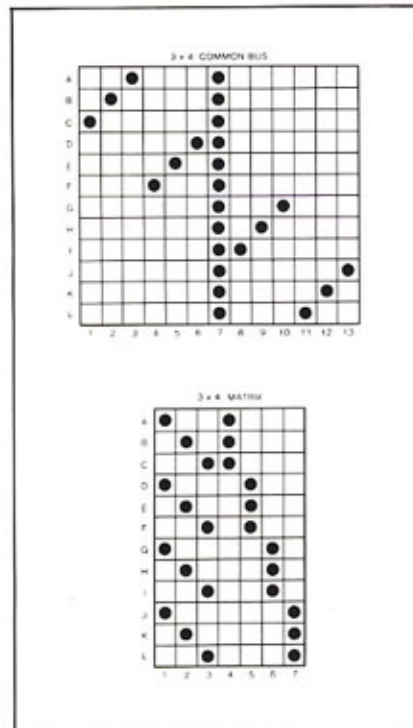
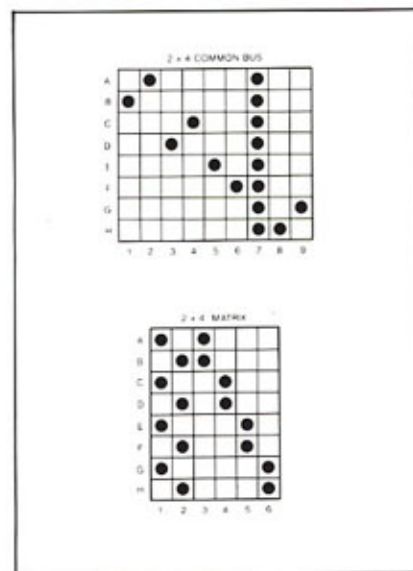
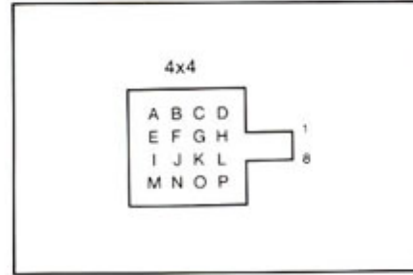
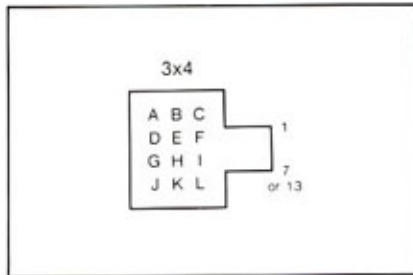
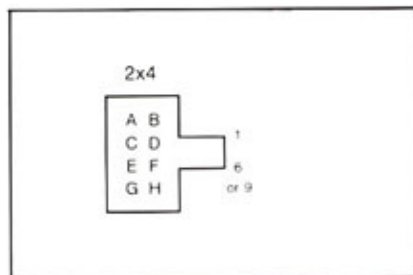
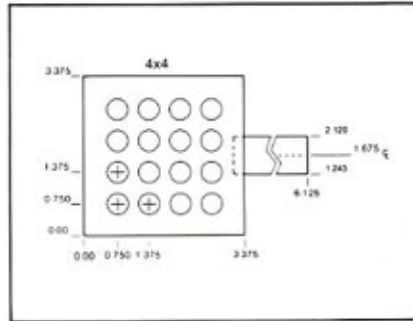
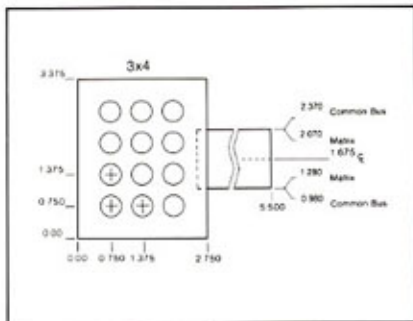
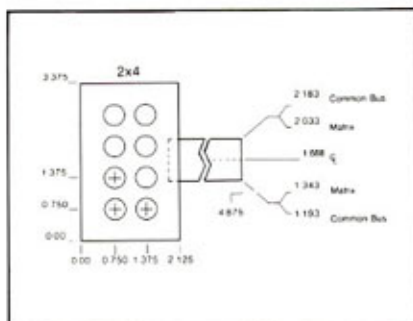

Catalog Numbers

Termination*

| | 1x4 common | 2x2 common | 2x4 common | 2x4 matrix | 3x4 common | 3x4 matrix | 4x4 matrix |
|-------------------|---------------|---------------|---------------|---------------|---------------|---------------|---------------|
| Without Connector | 12082 | 12422 | 12462 | 12472 | 12642 | 12652 | 12812 |
| With Connector | 12084 | 12424 | 12464 | 12474 | 12644 | 12654 | 12814 |

*See P. 3 for more information.

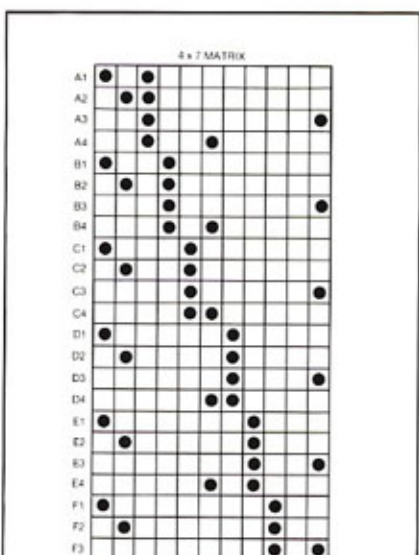
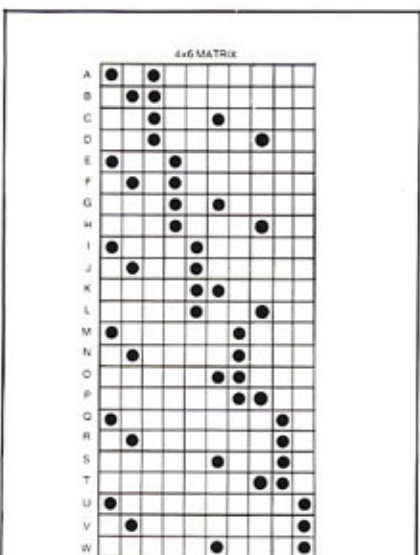
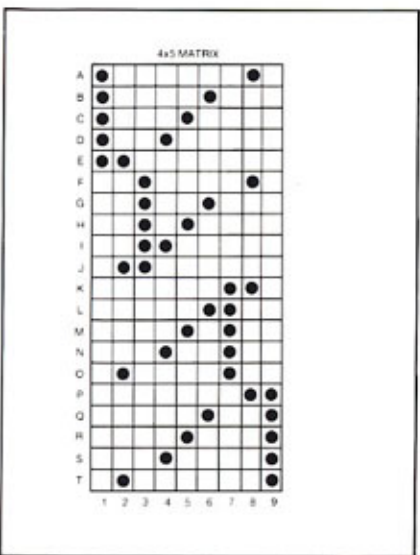
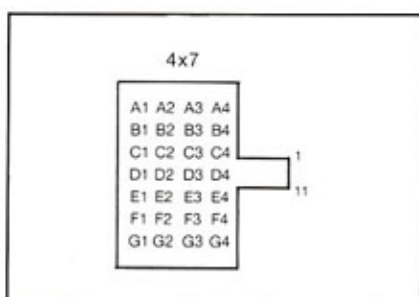
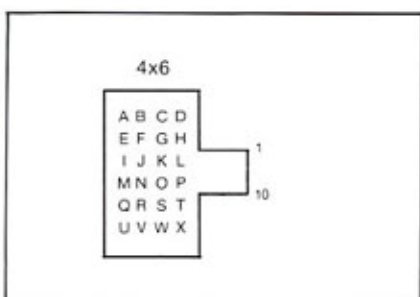
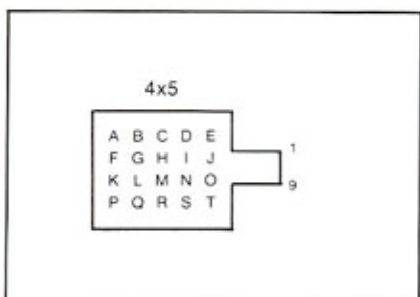
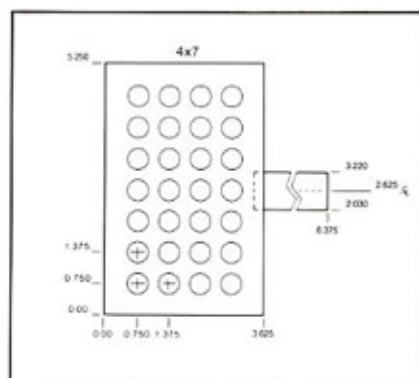
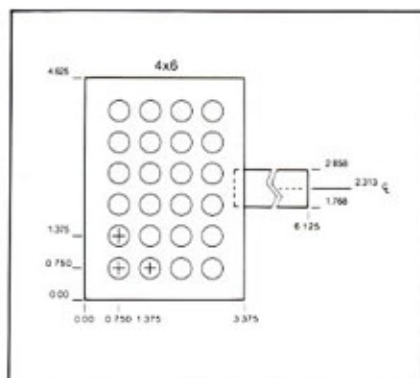
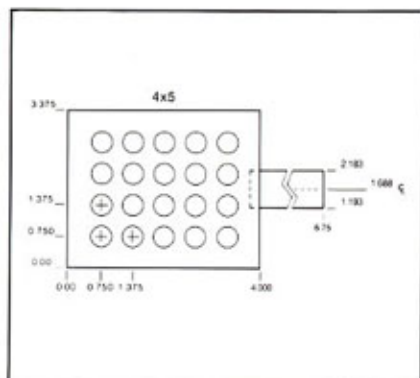
Catalog Numbers

| Termination* | 4x5 matrix | 4x6 matrix | 4x7 matrix |
|-------------------|------------|------------|------------|
| Without Connector | 13212 | 13312 | 13412 |
| With Connector | 13214 | 13314 | 13414 |

*See P. 3 for more information.

3/4" edge-abuttable switch strips are ideally suited for use where your product, by design, needs to be long and narrow. The switch strips on these two pages are compatible with all 3/4" edge abuttable switches.

Dimensions Shown: Inches

All Dimensions: $\pm 0.015"$

TAIL BREAKOUT

Shown is the recommended mounting surface slot detail for these stock products.

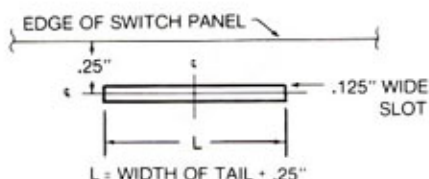

DETAIL of individual switch position



Outside Diameter = .500"

Pad diameter = .400"

LED window dia. = .125"

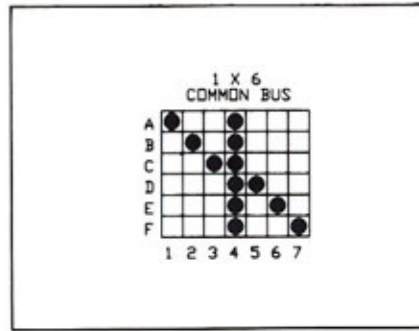
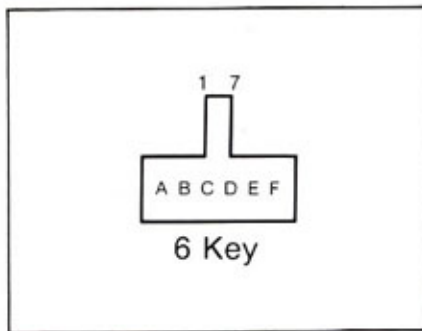
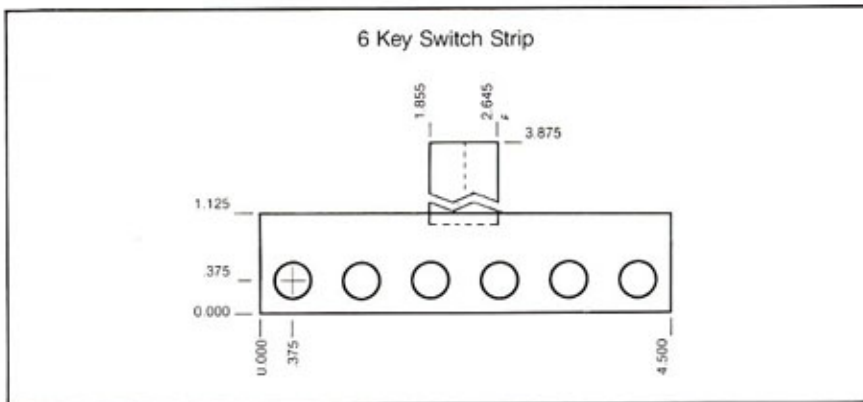
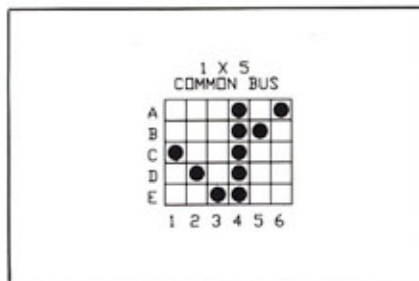
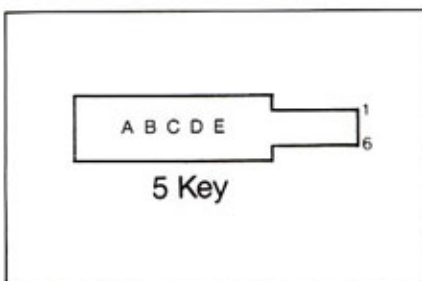
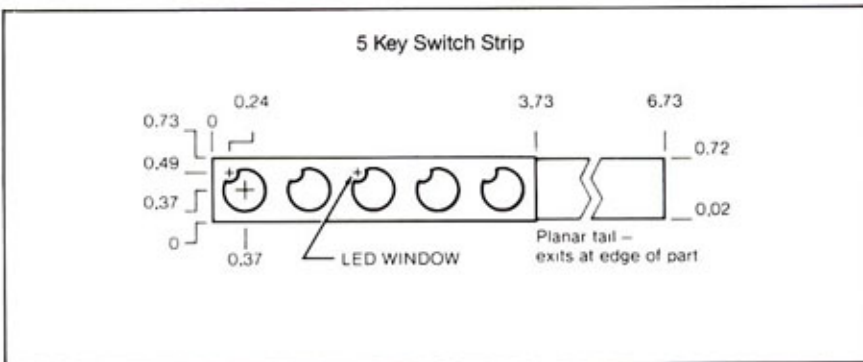
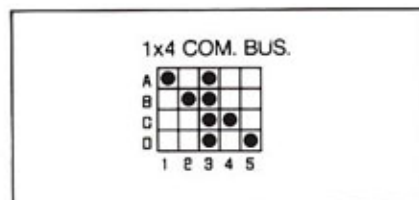
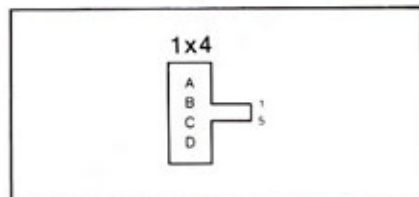
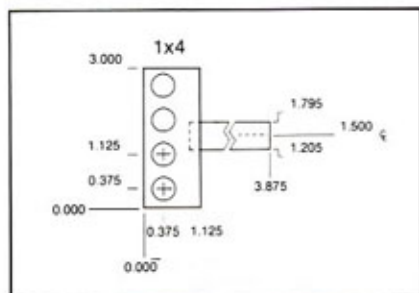

Catalog Numbers

| Termination* | 1x4 common | 5 Key | 6 Key |
|-------------------|------------|-------|-------|
| Without Connector | 14082 | 14122 | 14182 |
| With Connector | 14084 | 14124 | 14184 |

*See P. 3 for more information.

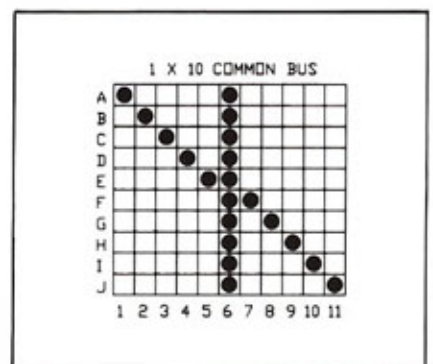
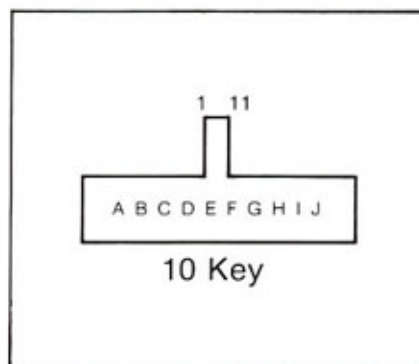
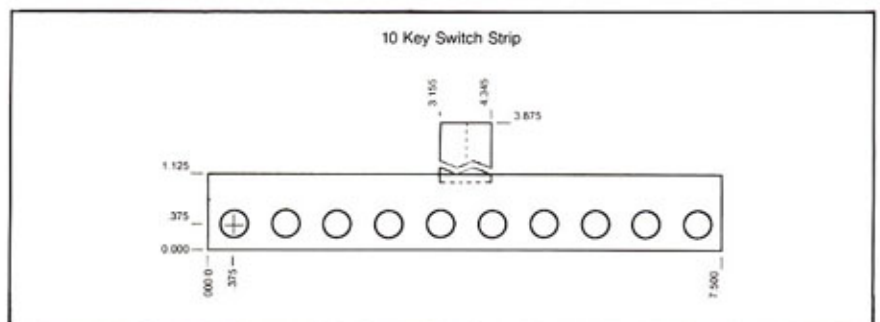
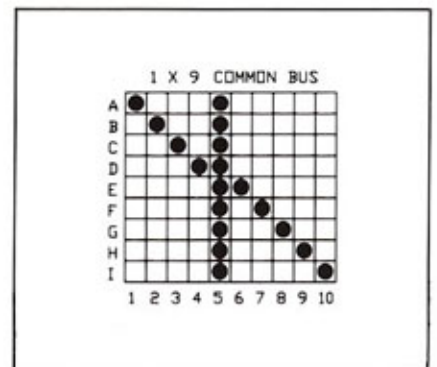
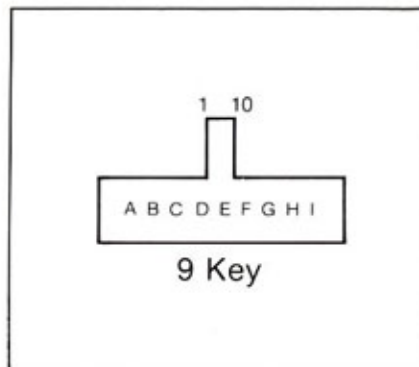
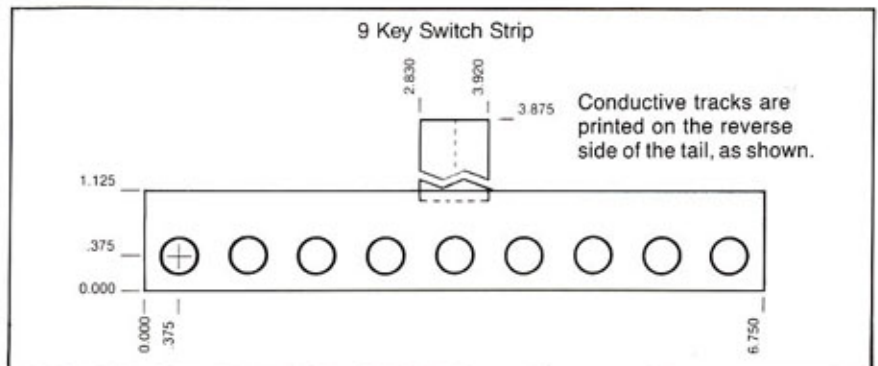

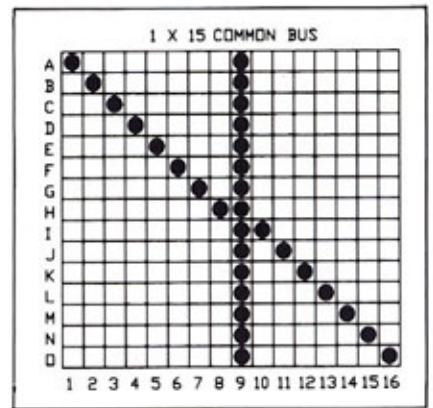
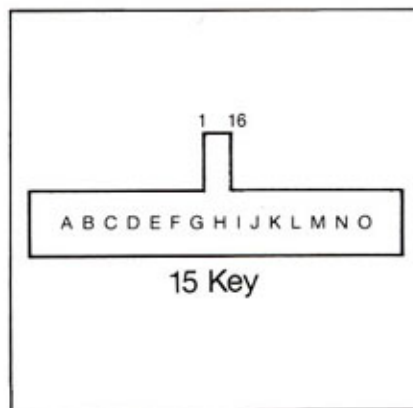
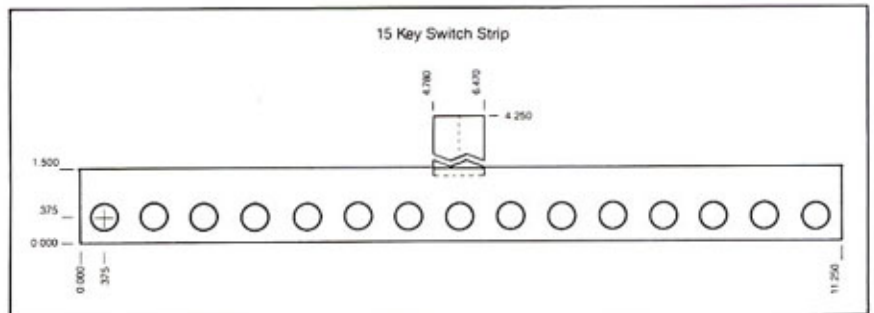
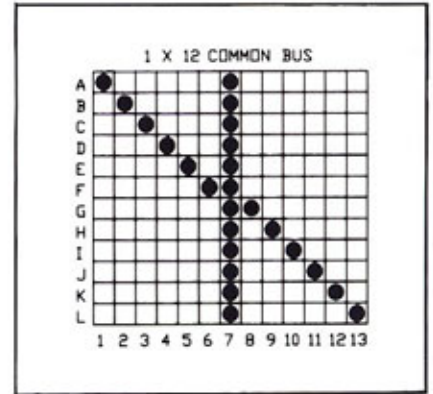
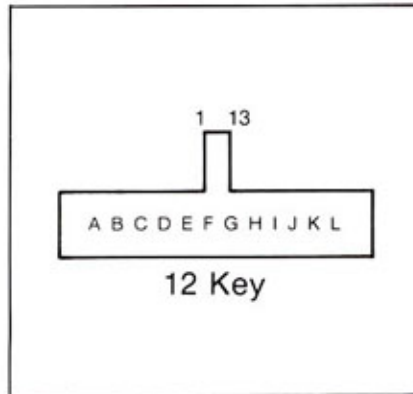
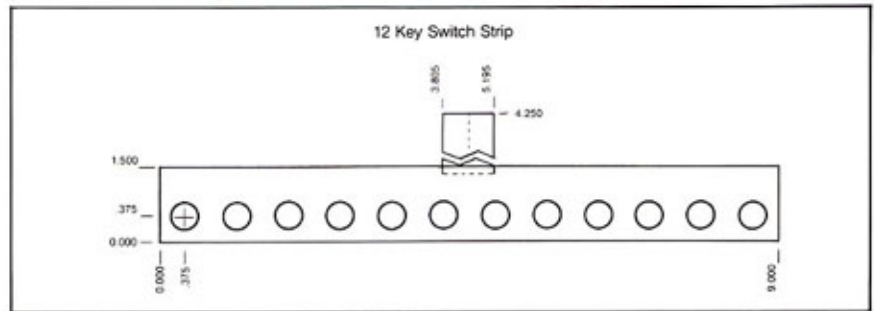

Catalog Numbers

| Termination* | 9 Key | 10 Key | 12 Key | 15 Key |
|-------------------|-------|--------|--------|--------|
| Without Connector | 14222 | 14242 | 14282 | 14342 |
| With Connector | 14224 | 14244 | 14284 | 14344 |

*See P. 3 for more information.

3/4" edge-abutable keypads are ideally suited for use in most membrane switching applications. They offer the user good spacing for easy finger placement in the key areas, as well as offering the designer enough "real estate" for good flexibility in graphic custom faceplate design. The keypads on these two pages are compatible with all 3/4" edge-abutable switches shown in this catalog.

Dimensions Shown: Inches

All Dimensions: ±0.015"

TAIL BREAKOUT

Shown is the recommended mounting surface slot detail for these stock products.

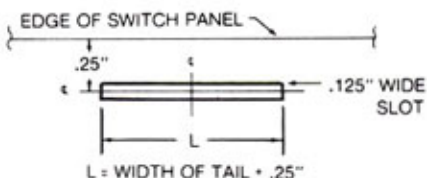

DETAIL of individual switch position



- Outside Diameter = .500"
- Pad diameter = .400"
- LED window dia. = .125"

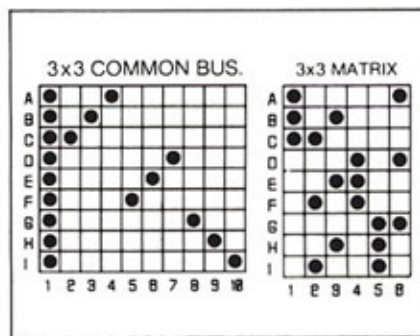
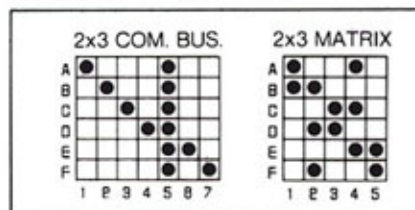
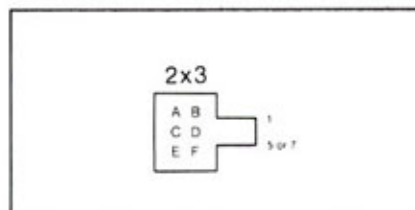
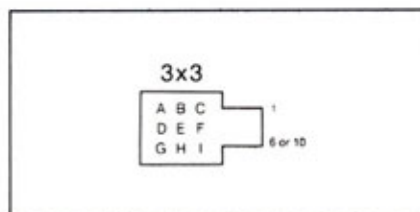
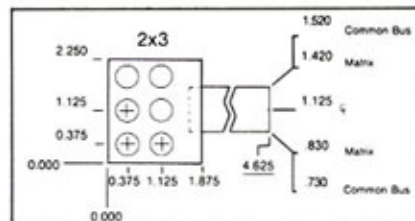
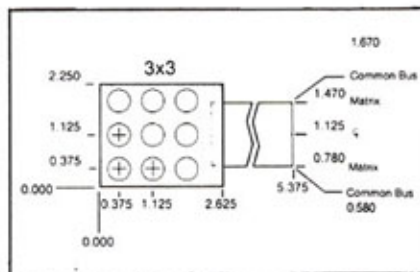
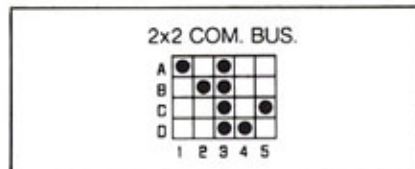
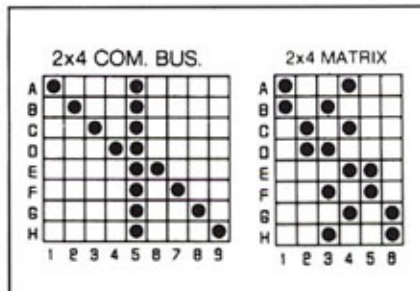
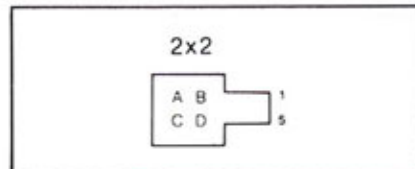
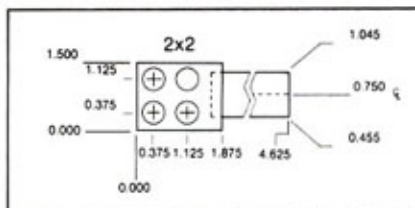
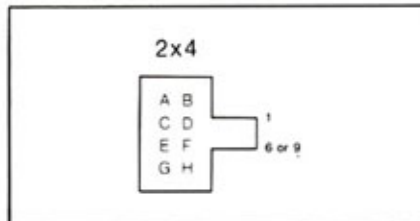
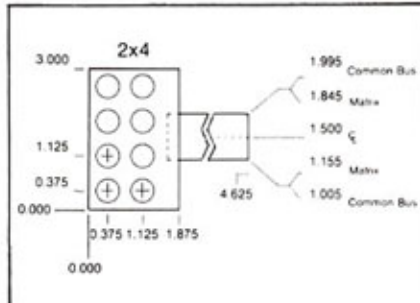
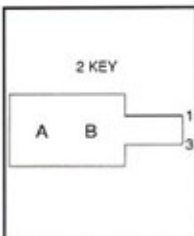
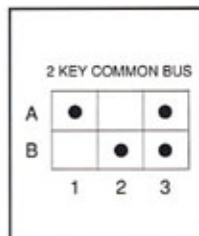
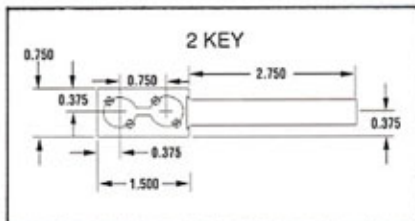

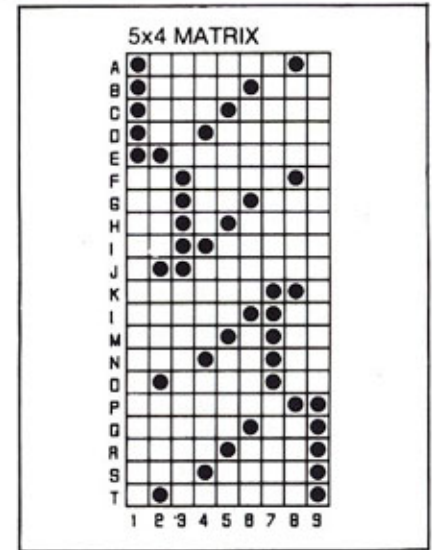
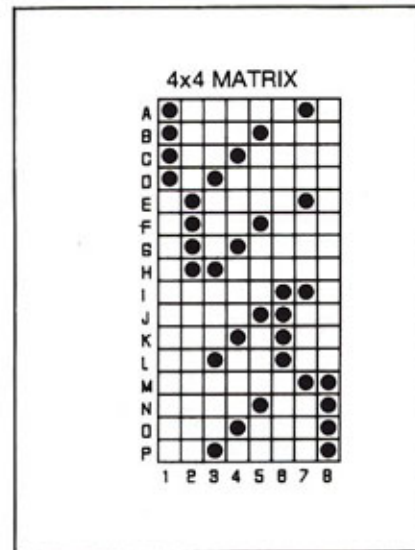
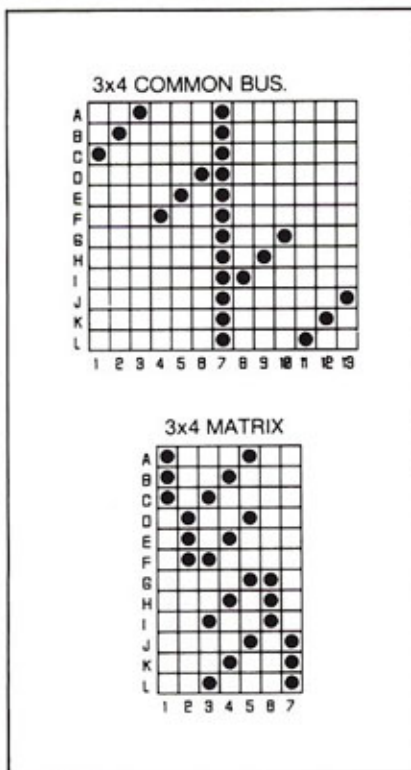
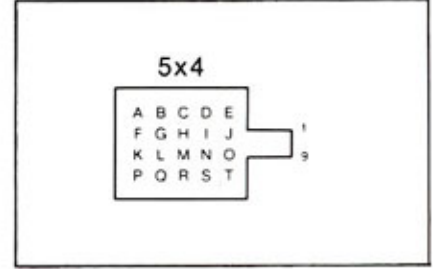
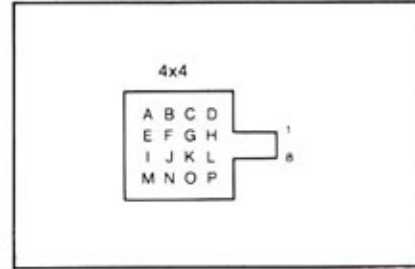
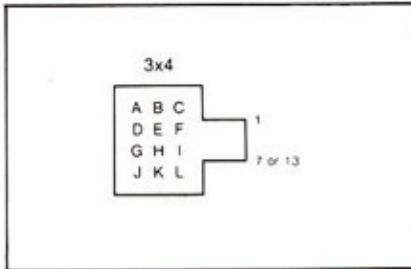
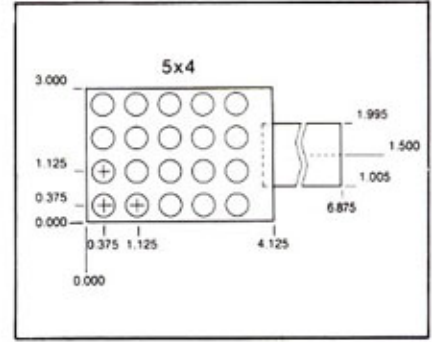
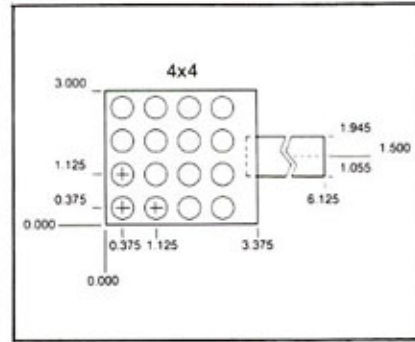
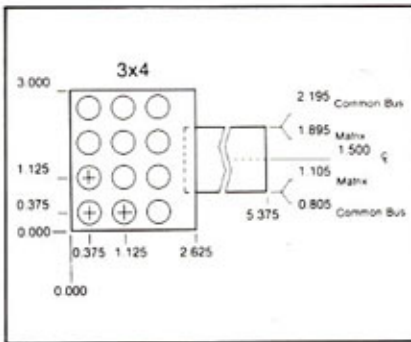

Catalog Numbers

| Termination* | 1 Key | 2 Key | 2x2 common | 2x3 common | 2x3 matrix | 2x4 common | 2x4 matrix | 3x3 common | 3x3 matrix | 3x4 common | 3x4 matrix | 4x4 matrix | 5x4 matrix |
|-------------------|-------|-------|------------|------------|------------|------------|------------|------------|------------|------------|------------|------------|------------|
| Without Connector | 14892 | 14902 | 14422 | 14442 | 14452 | 14462 | 14472 | 14602 | 14612 | 14642 | 14652 | 14812 | 15212 |
| With Connector | 14894 | 14904 | 14424 | 14444 | 14454 | 14464 | 14474 | 14604 | 14614 | 14644 | 14654 | 14814 | 15214 |

*See P. 3 for more information.

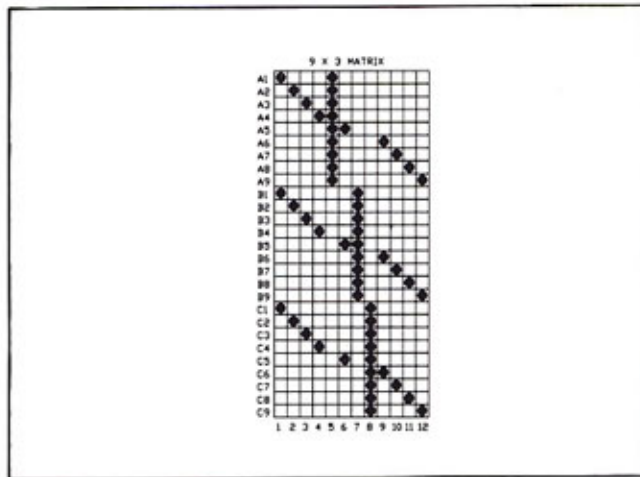
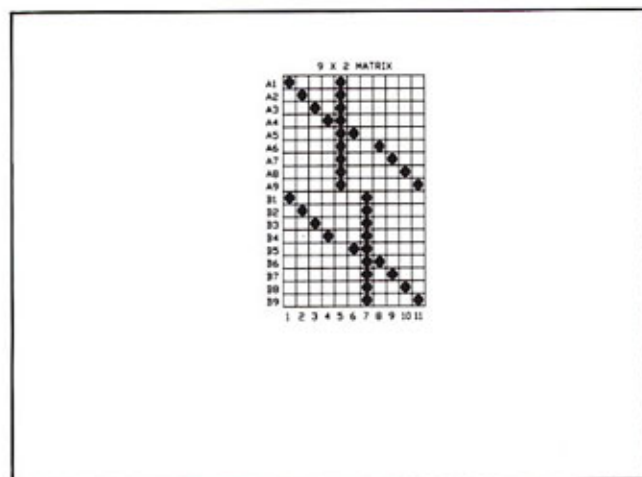
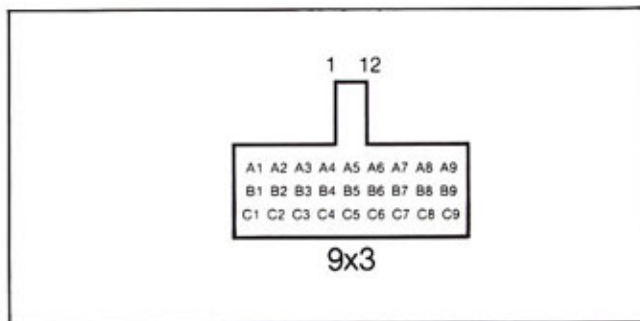
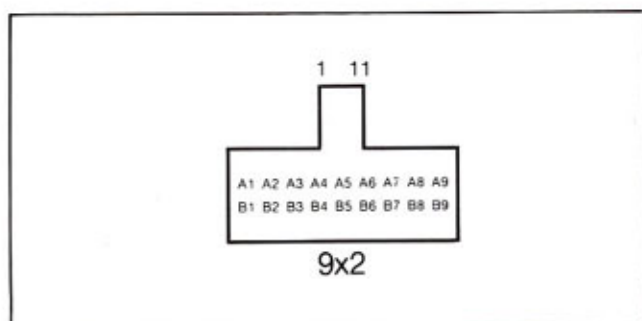
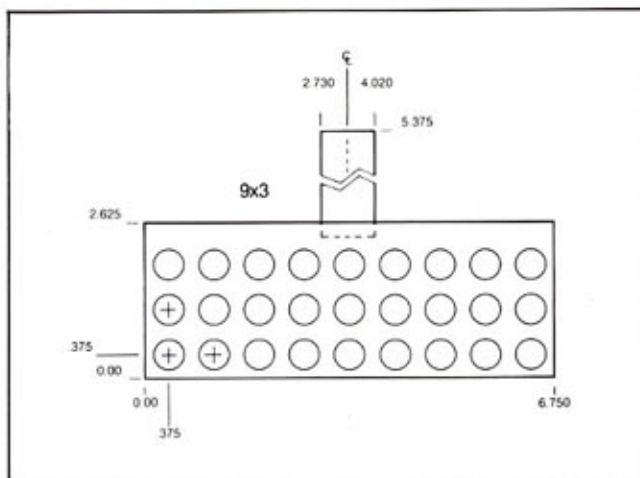
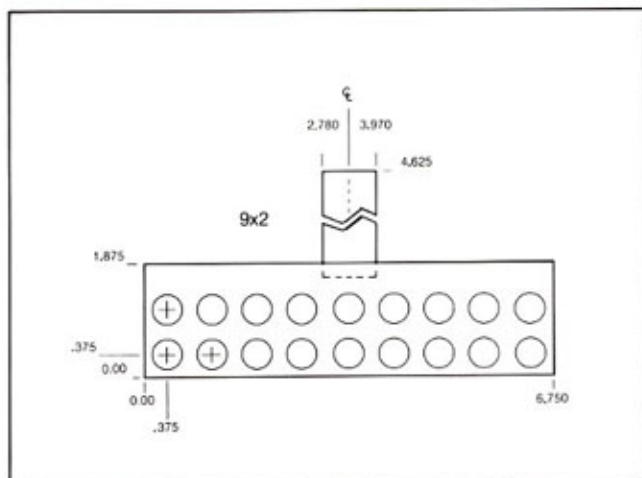

Catalog Numbers

| Termination* | 6x2 common | 6x2 matrix | 6x3 matrix | 6x4 matrix | 9x2 matrix | 9x3 matrix |
|-------------------|------------|------------|------------|------------|------------|------------|
| Without Connector | 14502 | 14522 | 14692 | 14832 | 14572 | 14752 |
| With Connector | 14504 | 14524 | 14694 | 14834 | 14574 | 14754 |

*See P. 3 for more information.

3/4" center to center keypads are ideally suited for use in most membrane switching applications. They offer the user good spacing for finger placement on the key areas as well as offering the designer good flexibility in graphic design.

Dimensions Shown: Inches

All Dimensions: $\pm 0.015"$

TAIL BREAKOUT

Shown is the recommended mounting surface slot detail for these stock products.

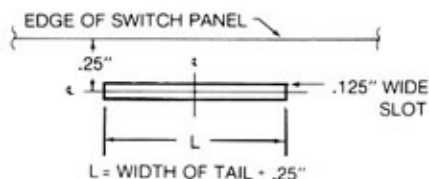

DETAIL of individual switch position



- Outside Diameter = .500"
- Pad diameter = .400"
- LED window dia. = .125"

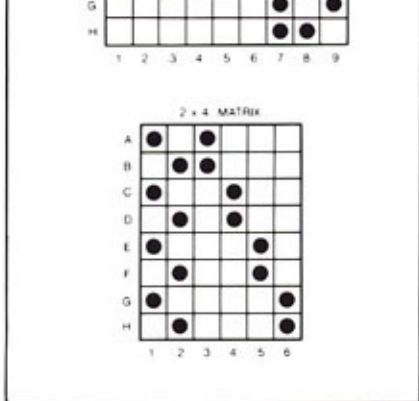
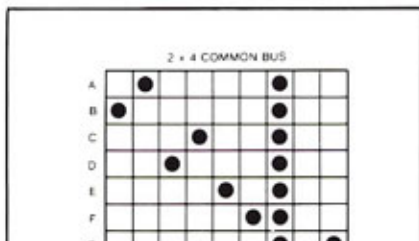
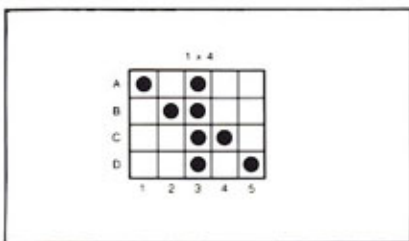
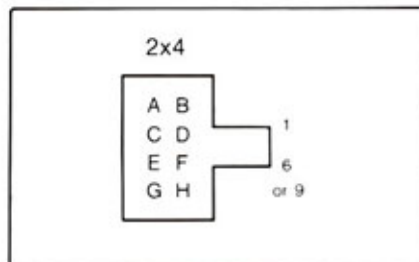
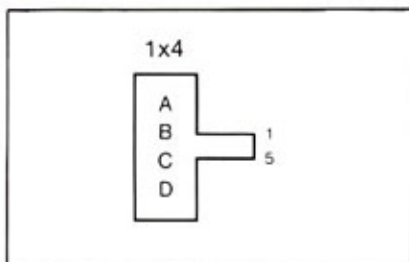
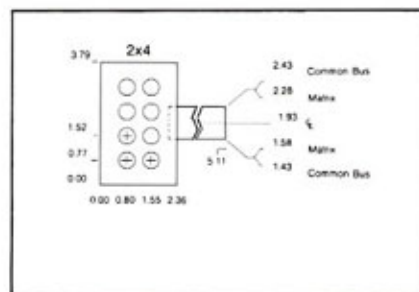
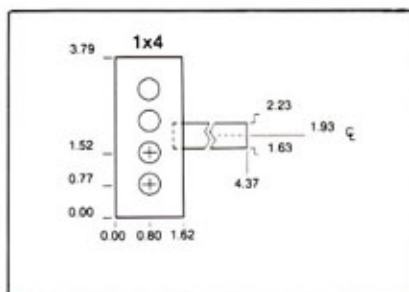

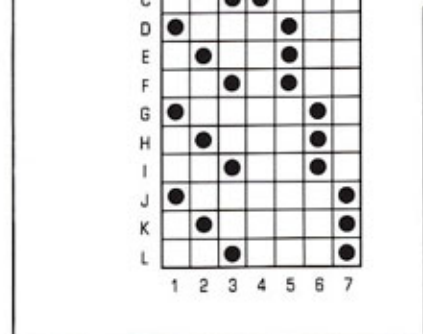
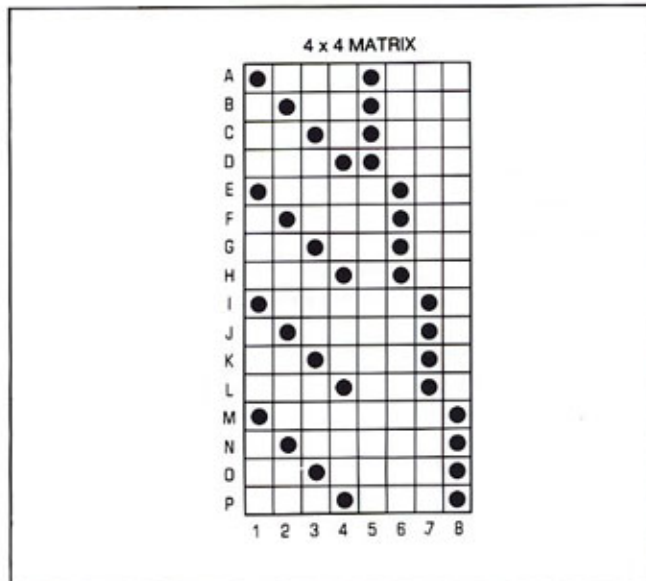
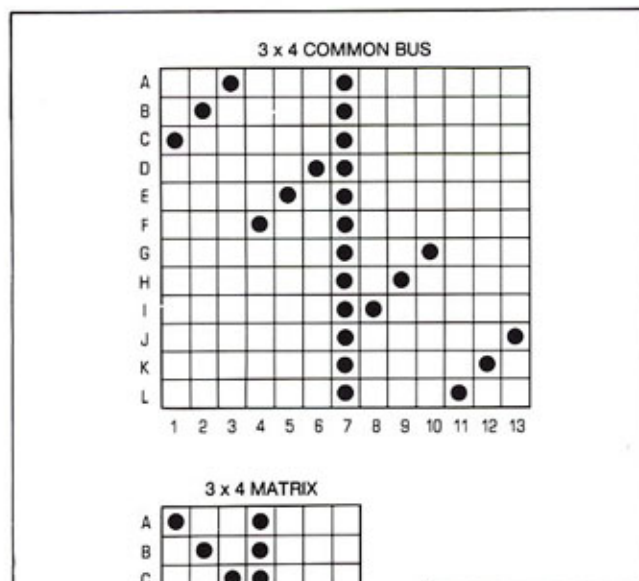
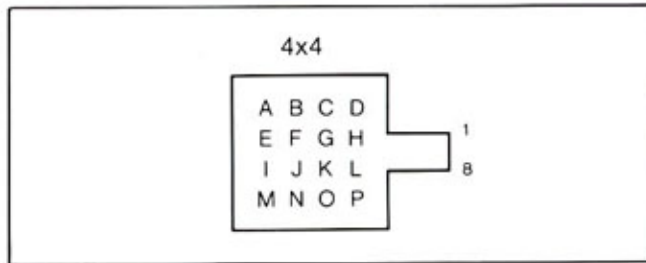
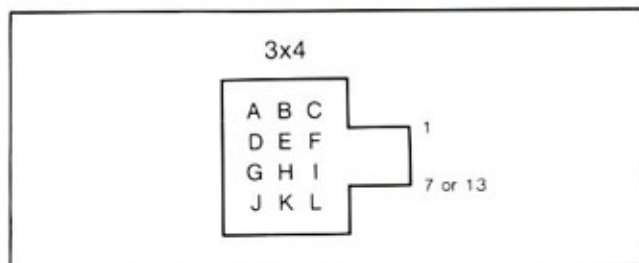
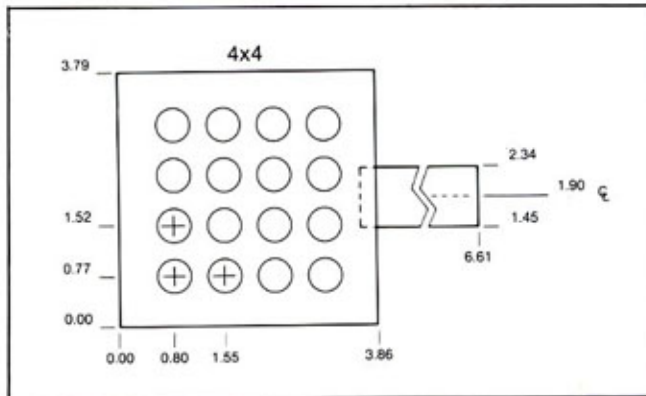
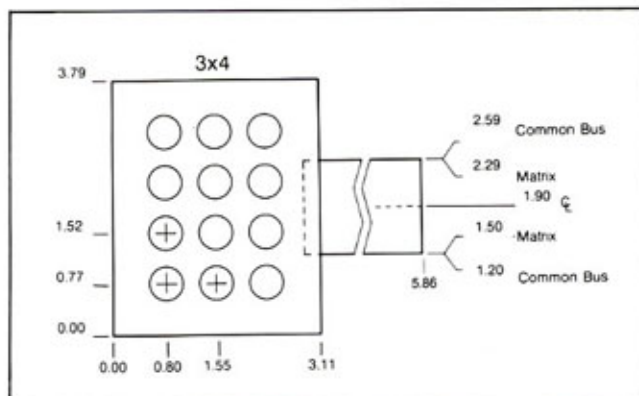

Catalog Numbers

| Termination* | 1x4 common | 2x4 common | 2x4 matrix | 3x4 common | 3x4 matrix | 4x4 matrix |
|-------------------|------------|------------|------------|------------|------------|------------|
| Without Connector | 14922 | 14942 | 14952 | 14962 | 14972 | 14992 |
| With Connector | 14924 | 14944 | 14954 | 14964 | 14974 | 14994 |

*See P. 3 for more information.

3/4" center to center keyboards are ideally suited for use where larger matrices and more switches are needed. They offer the user good spacing for finger placement on the key areas as well as offering the designer good flexibility in graphic faceplate design.

Dimensions Shown: Inches

All Dimensions: $\pm 0.015"$

TAIL BREAKOUT

Shown is the recommended mounting surface slot detail for these stock products.

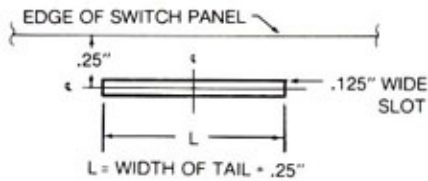

DETAIL of individual switch position



Outside Diameter = .500"

Pad diameter = .400"

LED window dia. = .125"

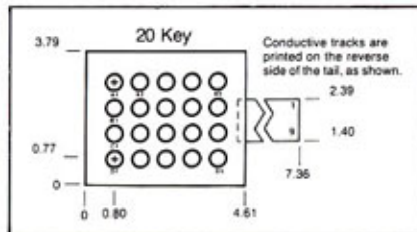

20 Key

| Key | Track No. | |
|-----|-----------|---|
| A1 | 9 | 3 |
| A2 | 8 | 3 |
| A3 | 1 | 3 |
| A4 | 2 | 3 |
| A5 | 5 | 3 |
| B1 | 9 | 4 |
| B2 | 8 | 4 |
| B3 | 1 | 4 |
| B4 | 2 | 4 |
| B5 | 5 | 4 |
| C1 | 9 | 6 |
| C2 | 8 | 6 |
| C3 | 1 | 6 |
| C4 | 2 | 6 |
| C5 | 5 | 6 |
| D1 | 9 | 7 |
| D2 | 8 | 7 |
| D3 | 1 | 7 |
| D4 | 2 | 7 |
| D5 | 5 | 7 |

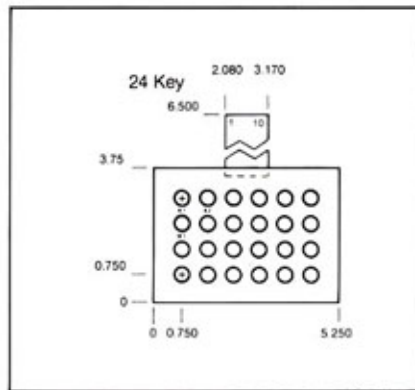

24 Key

| Key | Track No. | |
|-----|-----------|----|
| A1 | 1 | 5 |
| A2 | 2 | 5 |
| A3 | 4 | 5 |
| A4 | 6 | 5 |
| A5 | 7 | 5 |
| A6 | 8 | 5 |
| B1 | 1 | 3 |
| B2 | 2 | 3 |
| B3 | 4 | 3 |
| B4 | 6 | 3 |
| B5 | 7 | 3 |
| B6 | 8 | 3 |
| C1 | 1 | 9 |
| C2 | 2 | 9 |
| C3 | 4 | 9 |
| C4 | 6 | 9 |
| C5 | 7 | 9 |
| C6 | 8 | 9 |
| D1 | 1 | 10 |
| D2 | 2 | 10 |
| D3 | 4 | 10 |
| D4 | 6 | 10 |
| D5 | 7 | 10 |
| D6 | 8 | 10 |

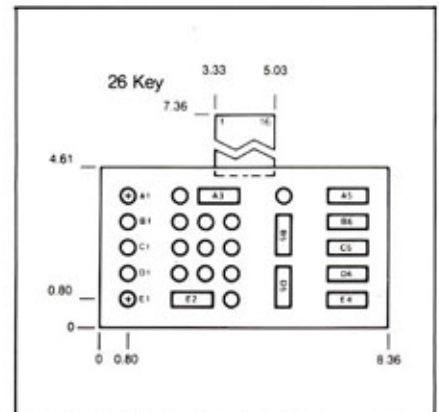

26 Key

| Key | Track No. | |
|-----|-----------|----|
| A1 | 16 | 9 |
| A2 | 5 | 8 |
| A3 | 5 | 6 |
| A4 | 10 | 11 |
| A5 | 10 | 13 |
| B1 | 15 | 9 |
| B2 | 4 | 8 |
| B3 | 4 | 7 |
| B4 | 4 | 6 |
| B5 | 12 | 11 |
| B6 | 12 | 13 |
| C1 | 14 | 9 |
| C2 | 3 | 8 |
| C3 | 3 | 7 |
| C4 | 3 | 6 |
| C5 | 14 | 13 |
| D1 | 10 | 9 |
| D2 | 2 | 8 |
| D3 | 2 | 7 |
| D4 | 2 | 6 |
| D5 | 14 | 11 |
| D6 | 15 | 13 |
| E1 | 12 | 9 |
| E2 | 1 | 7 |
| E3 | 1 | 6 |
| E4 | 16 | 13 |

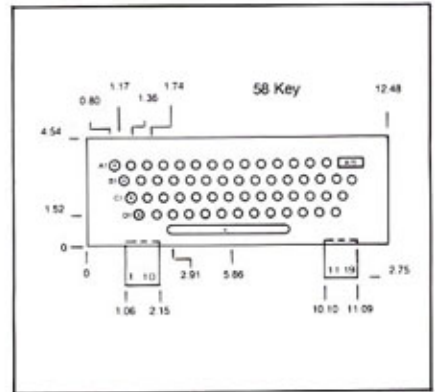
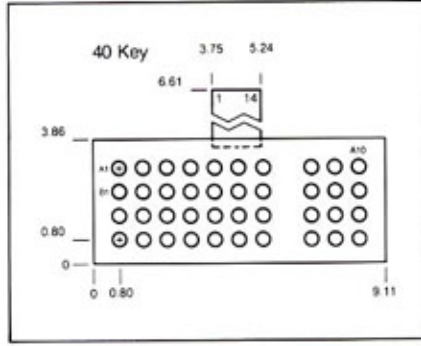
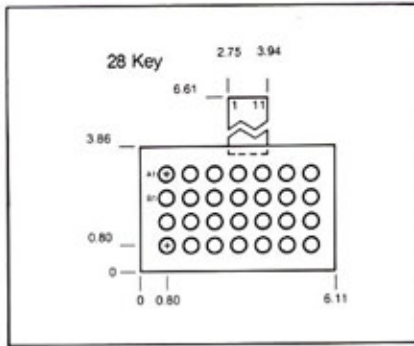

28 Key

| Key | Track No. |
|-----|-----------|
| A1 | 6 3 |
| A2 | 6 4 |
| A3 | 6 5 |
| A4 | 6 7 |
| A5 | 6 8 |
| A6 | 6 9 |
| A7 | 6 10 |
| B1 | 11 3 |
| B2 | 11 4 |
| B3 | 11 5 |
| B4 | 11 7 |
| B5 | 11 8 |
| B6 | 11 9 |
| B7 | 11 10 |
| C1 | 2 3 |
| C2 | 2 4 |
| C3 | 2 5 |
| C4 | 2 7 |
| C5 | 2 8 |
| C6 | 2 9 |
| C7 | 2 10 |
| D1 | 1 3 |
| D2 | 1 4 |
| D3 | 1 5 |
| D4 | 1 7 |
| D5 | 1 8 |
| D6 | 1 9 |
| D7 | 1 10 |

40 Key

| Key | Track No. | Key | Track No. |
|-----|-----------|-----|-----------|
| A1 | 7 1 | C1 | 10 1 |
| A2 | 7 2 | C2 | 10 2 |
| A3 | 7 3 | C3 | 10 3 |
| A4 | 7 4 | C4 | 10 4 |
| A5 | 7 5 | C5 | 10 5 |
| A6 | 7 6 | C6 | 10 6 |
| A7 | 7 9 | C7 | 10 9 |
| A8 | 7 12 | C8 | 10 12 |
| A9 | 7 13 | C9 | 10 13 |
| A10 | 7 14 | C10 | 10 14 |
| B1 | 8 1 | D1 | 11 1 |
| B2 | 8 2 | D2 | 11 2 |
| B3 | 8 3 | D3 | 11 3 |
| B4 | 8 4 | D4 | 11 4 |
| B5 | 8 5 | D5 | 11 5 |
| B6 | 8 6 | D6 | 11 6 |
| B7 | 8 9 | D7 | 11 9 |
| B8 | 8 12 | D8 | 11 12 |
| B9 | 8 13 | D9 | 11 13 |
| B10 | 8 14 | D10 | 11 14 |

58 Key

| Key | Track No. | Key | Track No. |
|-----|-----------|-----|-----------|
| A1 | 1 2 | B15 | 18 2 |
| A2 | 1 8 | C1 | 4 5 |
| A3 | 1 16 | C2 | 7 8 |
| A4 | 1 14 | C3 | 7 16 |
| A5 | 1 13 | C4 | 7 14 |
| A6 | 1 12 | C5 | 7 13 |
| A7 | 1 11 | C6 | 7 12 |
| A8 | 1 10 | C7 | 7 11 |
| A9 | 19 11 | C8 | 17 10 |
| A10 | 19 12 | C9 | 17 11 |
| A11 | 19 13 | C10 | 17 12 |
| A12 | 19 14 | C11 | 17 13 |
| A13 | 19 16 | C12 | 17 14 |
| A14 | 19 8 | C13 | 17 16 |
| A15 | 19 2 | C14 | 17 8 |
| B1 | 3 2 | D1 | 5 6 |
| B2 | 3 8 | D2 | 9 8 |
| B3 | 3 16 | D3 | 9 16 |
| B4 | 3 14 | D4 | 9 14 |
| B5 | 3 13 | D5 | 9 13 |
| B6 | 3 12 | D6 | 9 12 |
| B7 | 3 11 | D7 | 9 11 |
| B8 | 3 10 | D8 | 15 10 |
| B9 | 18 11 | D9 | 15 11 |
| B10 | 18 12 | D10 | 15 12 |
| B11 | 18 13 | D11 | 15 13 |
| B12 | 18 14 | D12 | 5 6 |
| B13 | 18 16 | D13 | 15 16 |
| B14 | 18 8 | Bar | 9 10 |

Catalog Numbers

| Termination* | 20 Key | 24 Key | 26 Key | 28 Key | 40 Key | 58 Key |
|-------------------|--------|--------|--------|--------|--------|--------|
| Without Connector | 15992 | 15312 | 15392 | 15412 | 15612 | 15912 |
| With Connector | 15994 | 15314 | 15394 | 15414 | 15614 | 15914 |

*See P. 3 for more information.

1" edge-abuttable keypads are ideally suited for use where larger than normal key spacings are required. They offer enlarged spacing between keys for finger placement in the proper key areas.

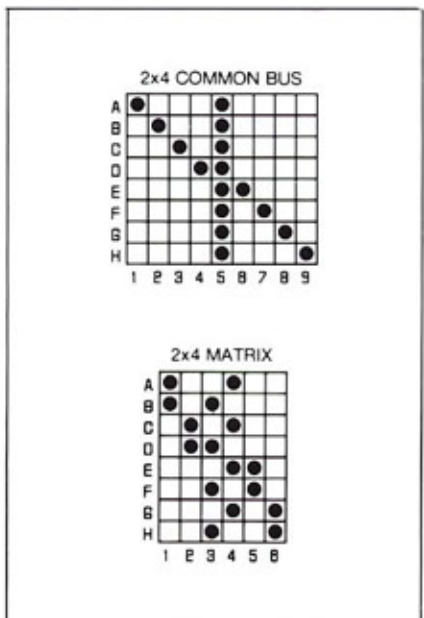
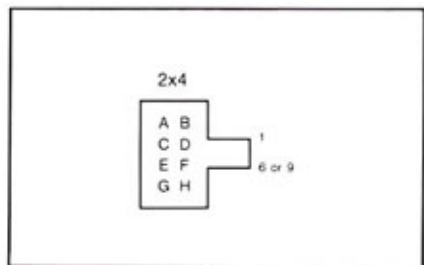
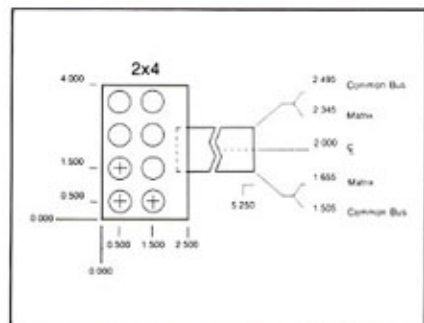
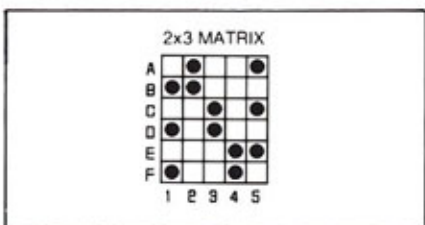
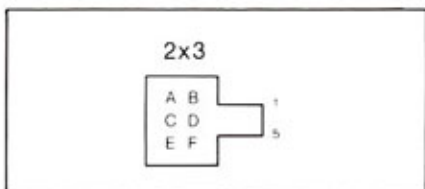
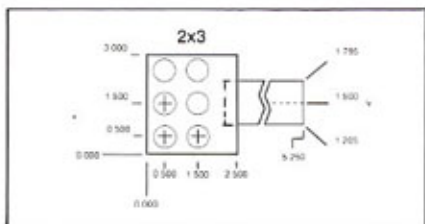
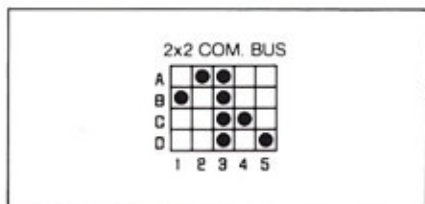
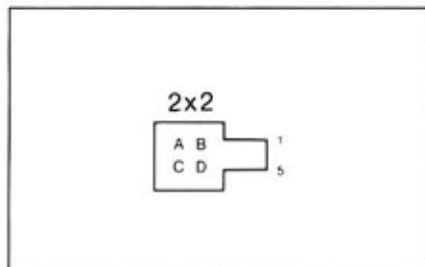
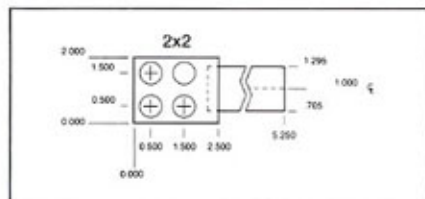

Dimensions Shown: Inches

All Dimensions: ± 0.015 "

TAIL BREAKOUT

Shown is the recommended mounting surface slot detail for these stock products.

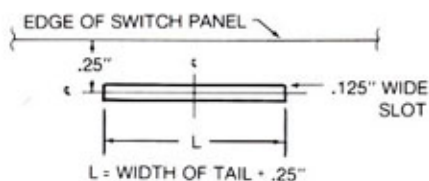

DETAIL of individual switch position



- Outside Diameter = .500"
- Pad diameter = .400"
- LED window dia. = .125"

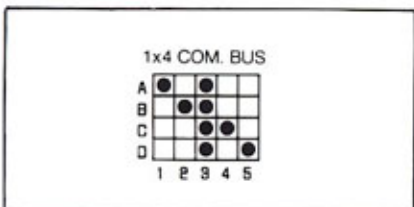
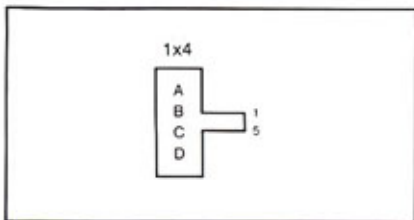
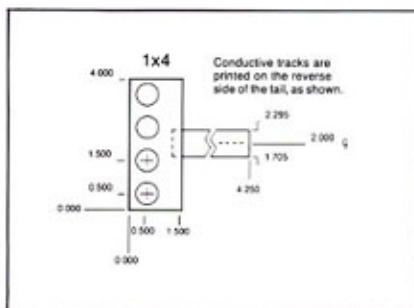

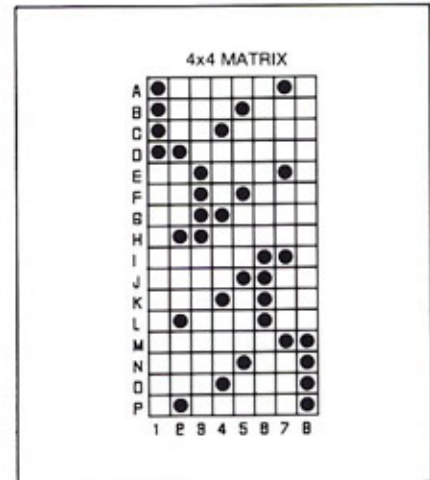
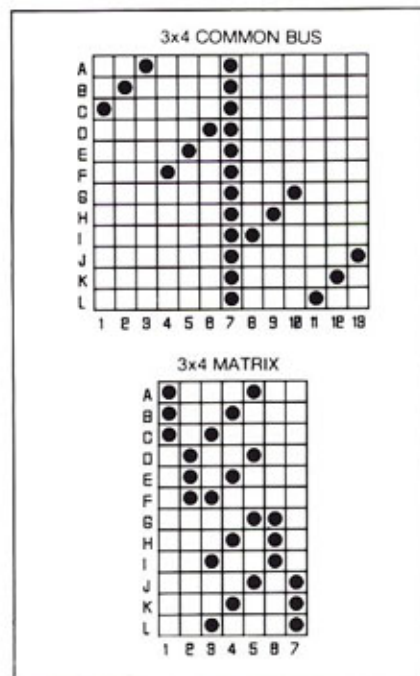
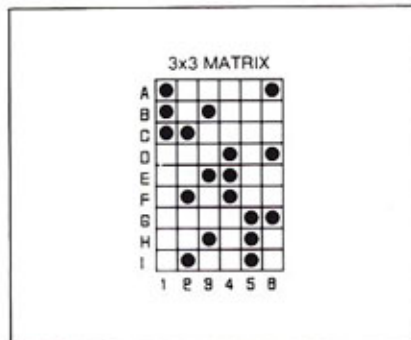
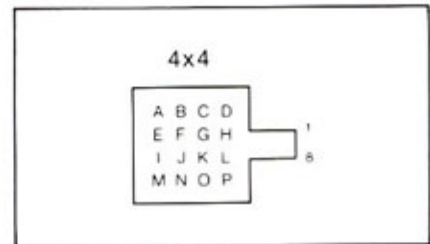
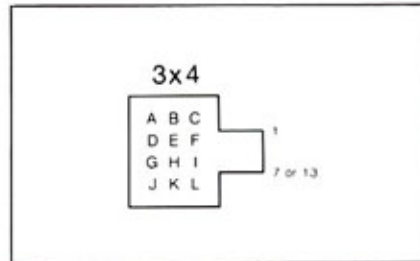
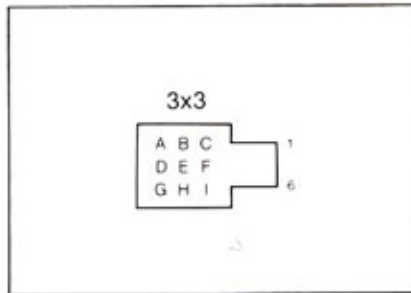
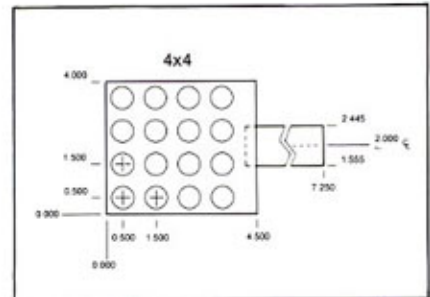
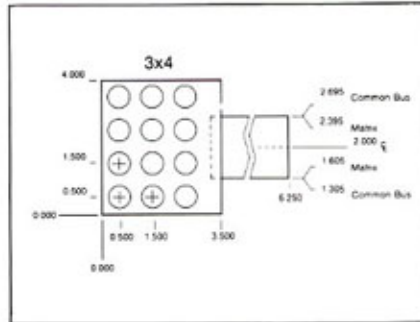
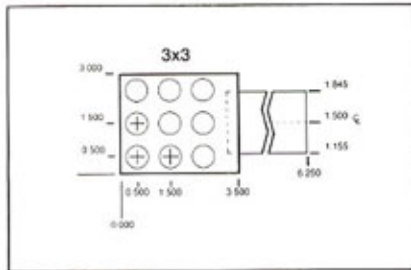

Catalog Numbers

| Termination* | 1x4 common | 2x2 common | 2x3 matrix | 2x4 common | 2x4 matrix | 3x3 matrix | 3x4 common | 3x4 matrix | 4x4 matrix |
|-------------------|------------|------------|------------|------------|------------|------------|------------|------------|------------|
| Without Connector | 16082 | 16422 | 16452 | 16462 | 16472 | 16612 | 16642 | 16652 | 16812 |
| With Connector | 16084 | 16424 | 16454 | 16464 | 16474 | 16614 | 16644 | 16654 | 16814 |

*See P. 3 for more information.

Individually terminated switches—are sold in strips of five and are used where only one discrete switch is needed. They are easily cut apart by the user and where requirements are large, they can be cut apart at the factory and shipped as single key switches.

Dimensions Shown: Inches

All Dimensions: $\pm 0.015"$

Individually Terminated Switches with Oversized Keys— $3/4"$ Centers

- Strips of five may be cut to form individual switches.
- Terminated with Berg connectors.
- Recommended key size: $1\ 1/4" \times 1\ 1/2"$ with LED windows, $1\ 3/8" \times 5/8"$ without LED windows.
- Active actuation area— $1\ 1/4" \times 7/16"$.
- Each switch on a separate circuit with two tracks on each tail.
- $1/8"$ diameter LED window.

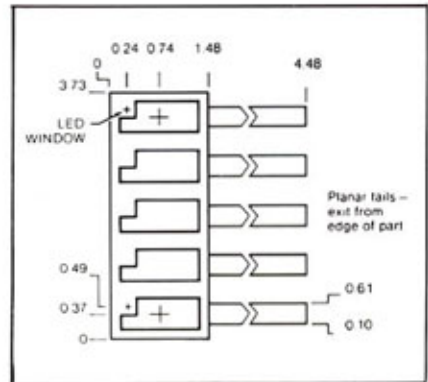

For use where stand-alone switches are required or where several switches with oversized keys are to be ganged with smaller switches.

$1\ 1/4"$ center to center 5 key switch strip—these switches are used where exceptionally large center to center spacings are required. These switches are edge-abutable on three sides, so when placed side by side they will maintain the $1\ 1/4"$ center to center spacing.

5 Key Switch Strip— $1\ 1/4"$ Centers

- Recommended key size— $3/4" \times 3/4"$.
- Active actuation area— $3/4" \times 3/4"$.

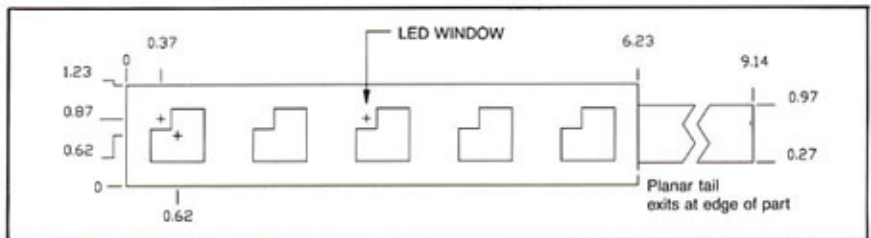

Catalog Numbers

| Termination* | 5 Key Individual | 5 Key Switch Strip $1\ 1/4"$ Centers |
|-------------------|------------------|--------------------------------------|
| Without Connector | ** 14142 | 16912 |
| With Connector | 14144 | 16914 |

*See P. 3 for more information. ** Tails are supplied without Molex holes.

Termination Schedule

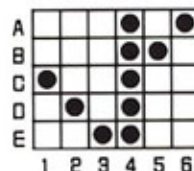

Xymox tactile feedback metal dome stock products are ideally suited for use in most membrane switching applications where user feedback is a requirement. They are constructed with stainless steel domes located over each switch position. The key spacing provided offers good finger placement as well as graphic design flexibility.

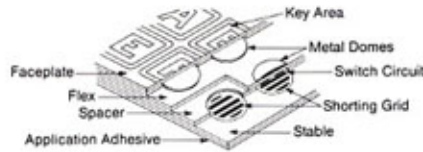

The adjacent illustration is of a typical tactile feedback membrane switch construction using metal domes. The metal domes are located at each switch position under the faceplate and on top of the flex circuitry layer. The metal domes provide tactile feedback only and are not part of the switch circuitry. A flat faceplate is shown. Other faceplate design options are available and illustrated below.

Faceplate Design Options

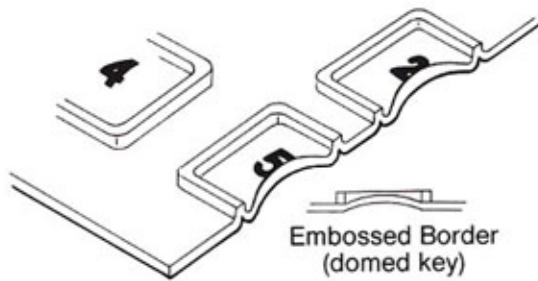

Embossed Border
(domed key)

Note: The faceplate design options shown here are for general illustration purposes only. Actual embossing or forming results in rounder edges than represented by the illustrations.

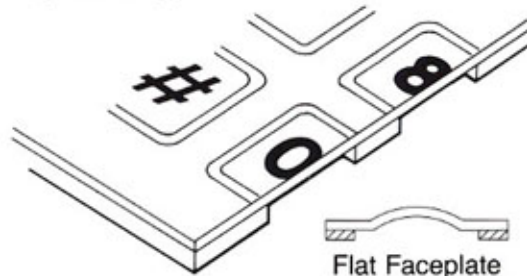

Flat Faceplate

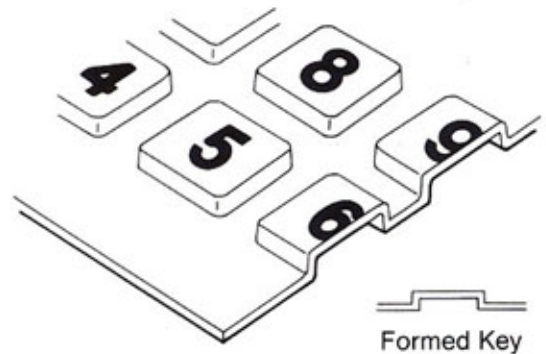

Formed Key

Xymox stock tactile feedback switches without faceplates have an activation force range of 10 to 12 oz. The addition of a custom faceplate will normally raise the activation force by 1 to 4 oz. Custom faceplates must be properly designed and manufactured to maintain the integrity and tactile feedback performance of the switch. Xymox stock tactile feedback switches are de-

signed to be used with faceplates that have acrylic based mounting adhesives of .002" or less in thickness. Thicker adhesives may close dome vent channels or cause performance problems with the switch. For additional information on designing custom faceplates to work with stock product tactile feedback switches contact your local Xymox Sales Representative.

Electrical Characteristics:

Contact Resistance: 100 ohms max., resistance varies proportionately with part size.
Open Circuit Resistance: 5×10^6 ohms min.
Current: 100 mA max.
Voltage: 30 VDC max.
Power: 1 watt max.
Contact Bounce: 1 ms nominal, 10 ms max. at rated life cycles.
Contact Material: Silver to silver.
Dielectric Strength: Polyester switch layers - 15,000V.

Physical Characteristics:

Life Cycles: 3,000,000 min. before loss of tactile feel; 5,000,000 min. electrical operation.
Operating Force: 8-14 oz. typical.
Switch Travel: .020"-.024" typical.
Termination: Flexible tail with contact tracks on 0.100" centers.
Overall Thickness: Approx. .040" without faceplate. Measured to top of dome.

Environmental Characteristics:

Operating Temperature: -34°C to 65°C (-40°F to 149°F).
Storage Temperature: -40°C to 65°C (-40°F to 149°F).
Elevated Temperature: No effect after 500 hours at 70°C.
Thermal Shock: No effect after 100 cycles from -40°C to 65°C.
Humidity: No effect after exposure to 95% relative humidity at 40°C for 504 hours.
Moisture Resistance: No effect after 10 cycles, each consisting of 24 hours from -10°C to 65°C and 95% relative humidity.

Construction Characteristics:

Tactile Feedback: Provided by stainless steel metal domes.
Reliability: Failure of dome does not result in switch failure.
Tail Breakout: Patented perpendicular tail design prevents airborne contaminants and liquid splashes from entering your electronics cabinet at the edge of the switch.
Circuitry: Matrix and common bus configurations allow design flexibility.

Faceplate Characteristics:

Material Description: Constructed from second surface printed polycarbonate (TDS #XD-101) or polyester (TDS #XD-102).
Substrate Finish: Shiny, matte, non-glare or selective non-glare polyester or shiny, velvet, suede or selective textured polycarbonate.
Adhesive: Transparent, unsupported, acrylic B196 pressure sensitive adhesive.
Color Options: Unlimited color selection and combinations.

Xymox® tactile feedback metal domes are ideally suited for use in membrane switch applications where essential user feedback is a requirement. The metal domes form a normally open, momentary contact, push-to-operate type switch when combined with a membrane switch circuit or assembly. Xymox tactile feedback metal domes are a non-contact variety. Non-contact rated domes are placed on top of the flexible circuitry layer of a membrane switch assembly and are not part of the switch circuitry. Non-contact rated domes provide tactile feedback only.

Note: Electrical specifications for non-contact rated domes represent use with typical flexible membrane switch. Values will vary with membrane switch construction and materials used.

CATALOG NUMBER **74110**

ELECTRICAL:

| | |
|-------------------------|-----------------------------|
| Contact Resistance | 100 ohms |
| Open Circuit Resistance | 5 x 10 ⁶ ohm min |
| Voltage Rating | 30 VDC |
| Current Rating | 100 mA |
| Power Rating | 1 watt |
| Contact Bounce | 20 ms max |
| Contact Material | Silver Ink (Typical) |

PHYSICAL:

| | |
|--------------------|---------------------|
| Life Cycles | 3 x 10 ⁶ |
| Operating Force | 10 ± 2 oz. |
| Dome Travel/Height | .022" |
| Dome Diameter | 0.500" |
| Dome/Switch Design | Non-Contact |

- Availability - stocked locally through a worldwide network of Xymox distributors.
- Reliability - proven through extensive testing.
- Economy - stock off-the-shelf domes eliminate custom setup or tooling charges.

Xymox tactile feedback metal dome stock products are ideally suited for use in most membrane switching applications where essential user feedback is a requirement. They are constructed with stainless steel domes located over each switch position. The key spacing provided offers good finger placement as well as graphic design flexibility.

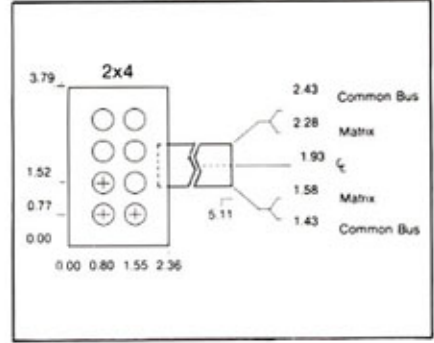
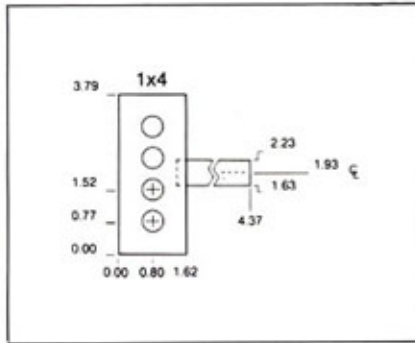

Dimensions Shown: Inches

All Dimensions: $\pm 0.015"$

TAIL BREAKOUT

Shown is the recommended mounting surface slot detail for these stock products.

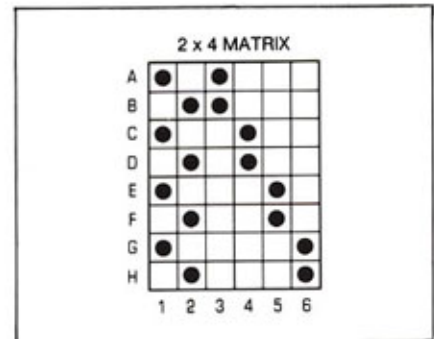
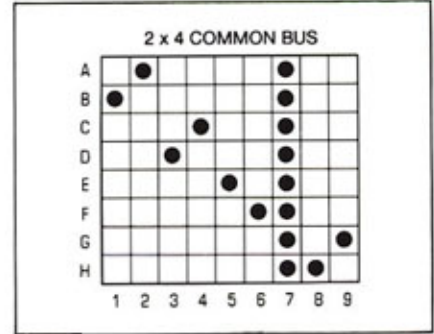
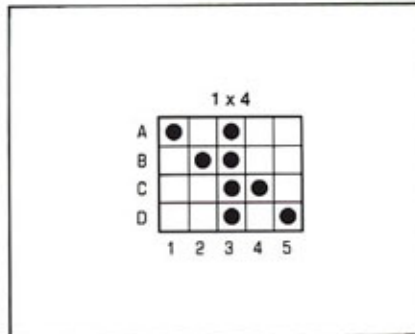
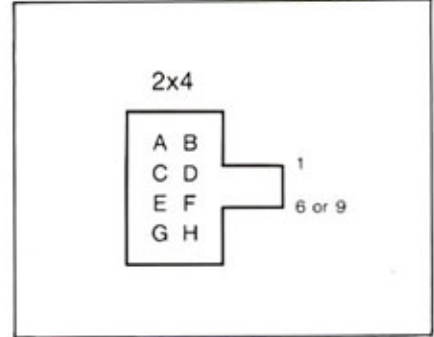
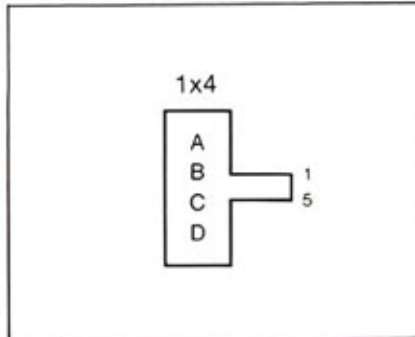
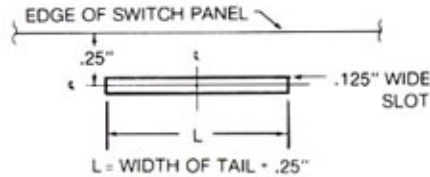

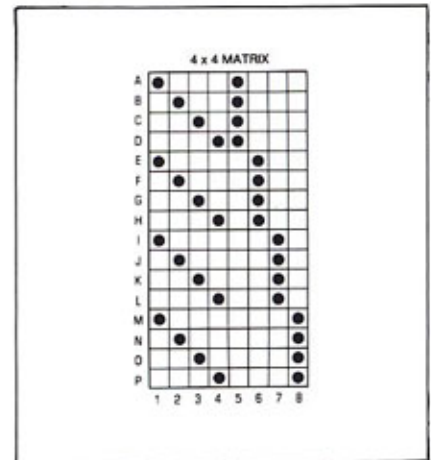
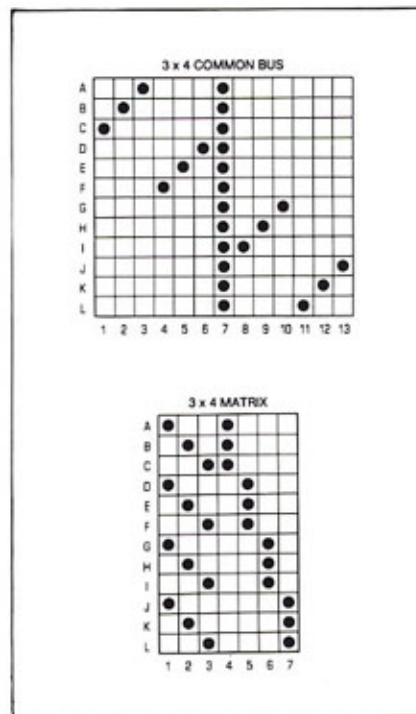
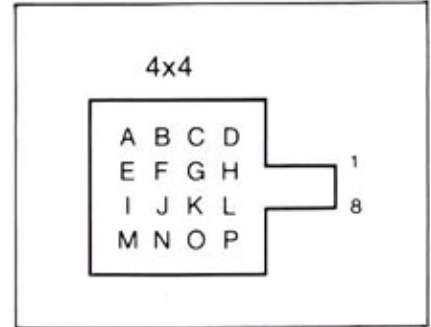
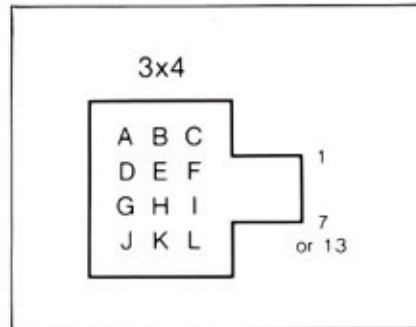
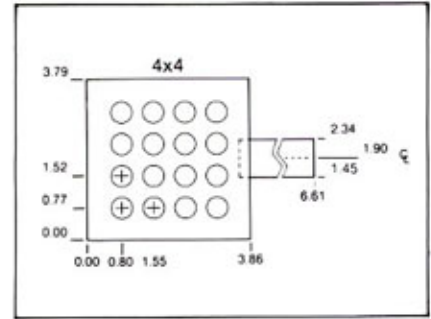
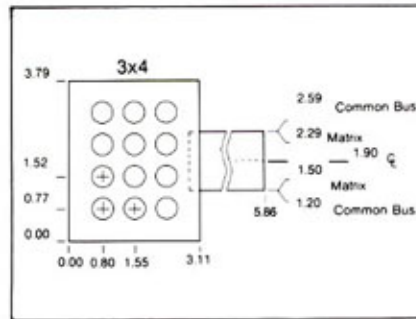

Catalog Numbers

| Termination* | 1x4 common | 2x4 common | 2x4 matrix | 3x4 common | 3x4 matrix | 4x4 matrix |
|-------------------|---------------|---------------|---------------|---------------|---------------|---------------|
| Without Connector | 54922 | 54942 | 54952 | 54962 | 54972 | 54992 |
| With Connector | 54924 | 54944 | 54954 | 54964 | 54974 | 54994 |

*See P. 3 for more information.

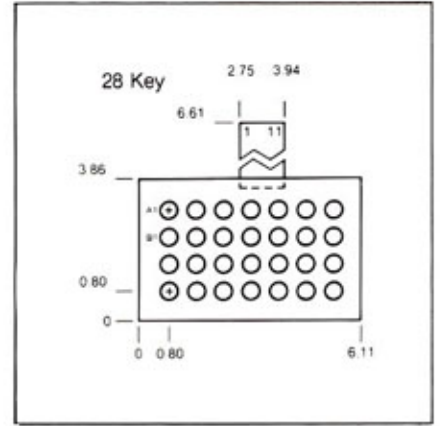
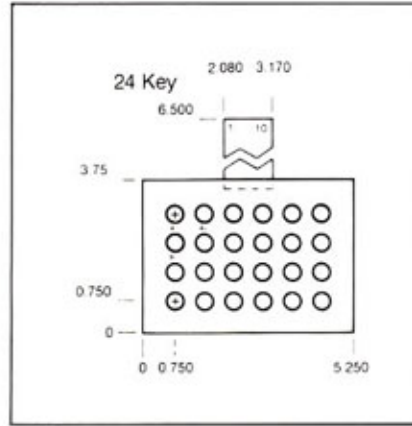
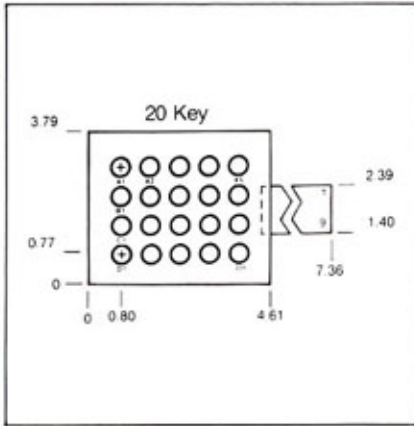

20 Key

| Key | Track No. |
|-----|-----------|
| A1 | 9 3 |
| A2 | 8 3 |
| A3 | 1 3 |
| A4 | 2 3 |
| A5 | 5 3 |
| B1 | 9 4 |
| B2 | 8 4 |
| B3 | 1 4 |
| B4 | 2 4 |
| B5 | 5 4 |
| C1 | 9 6 |
| C2 | 8 6 |
| C3 | 1 6 |
| C4 | 2 6 |
| C5 | 5 6 |
| D1 | 9 7 |
| D2 | 8 7 |
| D3 | 1 7 |
| D4 | 2 7 |
| D5 | 5 7 |

24 Key

| Key | Track No. |
|-----|-----------|
| A1 | 1 5 |
| A2 | 2 5 |
| A3 | 4 5 |
| A4 | 6 5 |
| A5 | 7 5 |
| A6 | 8 5 |
| B1 | 1 3 |
| B2 | 2 3 |
| B3 | 4 3 |
| B4 | 6 3 |
| B5 | 7 3 |
| B6 | 8 3 |
| C1 | 1 9 |
| C2 | 2 9 |
| C3 | 4 9 |
| C4 | 6 9 |
| C5 | 7 9 |
| C6 | 8 9 |
| D1 | 1 10 |
| D2 | 2 10 |
| D3 | 4 10 |
| D4 | 6 10 |
| D5 | 7 10 |
| D6 | 8 10 |

28 Key

| Key | Track No. |
|-----|-----------|
| A1 | 6 3 |
| A2 | 6 4 |
| A3 | 6 5 |
| A4 | 6 7 |
| A5 | 6 8 |
| A6 | 6 9 |
| A7 | 6 10 |
| B1 | 11 3 |
| B2 | 11 4 |
| B3 | 11 5 |
| B4 | 11 7 |
| B5 | 11 8 |
| B6 | 11 9 |
| B7 | 11 10 |
| C1 | 2 3 |
| C2 | 2 4 |
| C3 | 2 5 |
| C4 | 2 7 |
| C5 | 2 8 |
| C6 | 2 9 |
| C7 | 2 10 |
| D1 | 1 3 |
| D2 | 1 4 |
| D3 | 1 5 |
| D4 | 1 7 |
| D5 | 1 8 |
| D6 | 1 9 |
| D7 | 1 10 |

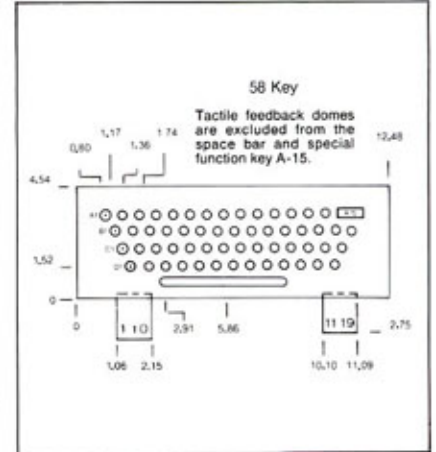
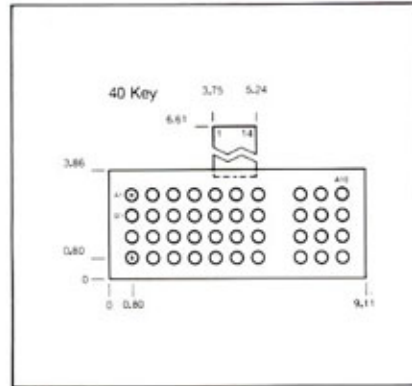

40 Key

| Key | Track | No. | Key | Track | No. |
|-----|-------|-----|-----|-------|-----|
| A1 | 7 | 1 | C1 | 10 | 1 |
| A2 | 7 | 2 | C2 | 10 | 2 |
| A3 | 7 | 3 | C3 | 10 | 3 |
| A4 | 7 | 4 | C4 | 10 | 4 |
| A5 | 7 | 5 | C5 | 10 | 5 |
| A6 | 7 | 6 | C6 | 10 | 6 |
| A7 | 7 | 9 | C7 | 10 | 9 |
| A8 | 7 | 12 | C8 | 10 | 12 |
| A9 | 7 | 13 | C9 | 10 | 13 |
| A10 | 7 | 14 | C10 | 10 | 14 |
| B1 | 8 | 1 | D1 | 11 | 1 |
| B2 | 8 | 2 | D2 | 11 | 2 |
| B3 | 8 | 3 | D3 | 11 | 3 |
| B4 | 8 | 4 | D4 | 11 | 4 |
| B5 | 8 | 5 | D5 | 11 | 5 |
| B6 | 8 | 6 | D6 | 11 | 6 |
| B7 | 8 | 9 | D7 | 11 | 9 |
| B8 | 8 | 12 | D8 | 11 | 12 |
| B9 | 8 | 13 | D9 | 11 | 13 |
| B10 | 8 | 14 | D10 | 11 | 14 |

58 Key

| Key | Track | No. | Key | Track | No. |
|-----|-------|-----|-----|-------|-----|
| A1 | 1 | 2 | B15 | 18 | 2 |
| A2 | 1 | 8 | C1 | 4 | 5 |
| A3 | 1 | 16 | C2 | 7 | 8 |
| A4 | 1 | 14 | C3 | 7 | 16 |
| A5 | 1 | 13 | C4 | 7 | 14 |
| A6 | 1 | 12 | C5 | 7 | 13 |
| A7 | 1 | 11 | C6 | 7 | 12 |
| A8 | 1 | 10 | C7 | 7 | 11 |
| A9 | 19 | 11 | C8 | 17 | 10 |
| A10 | 19 | 12 | C9 | 17 | 11 |
| A11 | 19 | 13 | C10 | 17 | 12 |
| A12 | 19 | 14 | C11 | 17 | 13 |
| A13 | 19 | 16 | C12 | 17 | 14 |
| A14 | 19 | 8 | C13 | 17 | 16 |
| A15 | 19 | 2 | C14 | 17 | 8 |
| B1 | 3 | 2 | D1 | 5 | 6 |
| B2 | 3 | 8 | D2 | 9 | 8 |
| B3 | 3 | 16 | D3 | 9 | 16 |
| B4 | 3 | 14 | D4 | 9 | 14 |
| B5 | 3 | 13 | D5 | 9 | 13 |
| B6 | 3 | 12 | D6 | 9 | 12 |
| B7 | 3 | 11 | D7 | 9 | 11 |
| B8 | 3 | 10 | D8 | 15 | 10 |
| B9 | 18 | 11 | D9 | 15 | 11 |
| B10 | 18 | 12 | D10 | 15 | 12 |
| B11 | 18 | 13 | D11 | 15 | 13 |
| B12 | 18 | 14 | D12 | 5 | 6 |
| B13 | 18 | 16 | D13 | 15 | 16 |
| B14 | 18 | 8 | Bar | 9 | 10 |

Catalog Numbers

| Termination* | 20 Key | 24 Key | 28 Key | 40 Key | 58 Key |
|-------------------|--------|--------|--------|--------|--------|
| Without Connector | 55992 | 55312 | 55412 | 55612 | 55912 |
| With Connector | 55994 | 55314 | 55414 | 55614 | 55914 |

*See P. 3 for more information.

Xymox tactile feedback metal dome stock products are ideally suited for use in most membrane switching applications where user feedback is a requirement. They are constructed with stainless steel domes located over each switch position. The key spacing provided offers good finger placement as well as graphic design flexibility.

Dimensions Shown: Inches

All Dimensions: $\pm 0.015"$

TAIL BREAKOUT

Shown is the recommended mounting surface slot detail for these stock products.

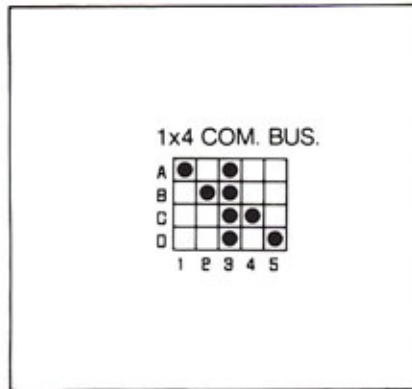
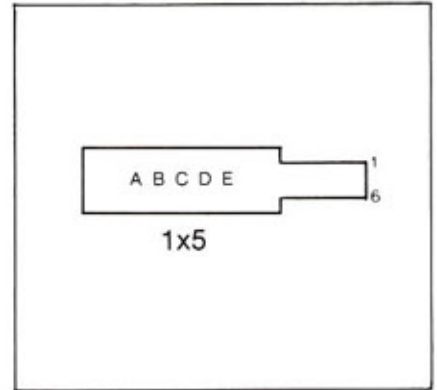
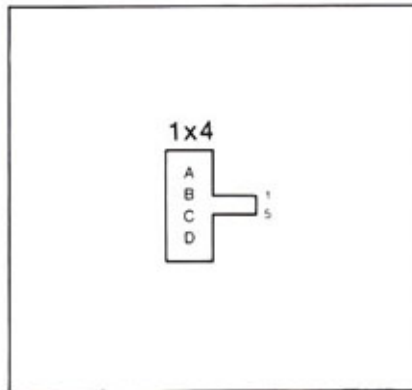
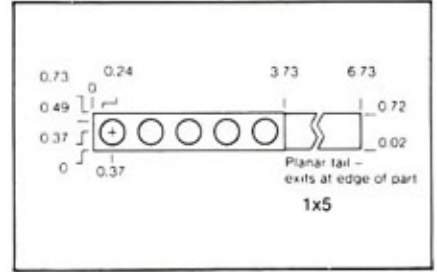
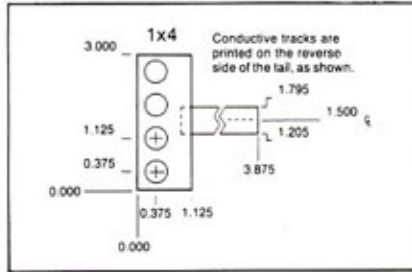
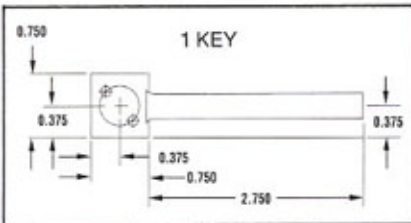
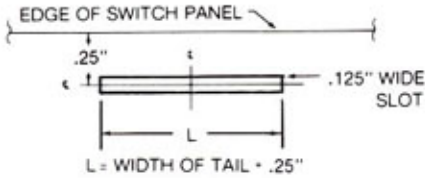

1x5

| Key | Track No. |
|-----|-----------|
| A | 6 4 |
| B | 5 4 |
| C | 1 4 |
| D | 2 4 |
| E | 3 4 |

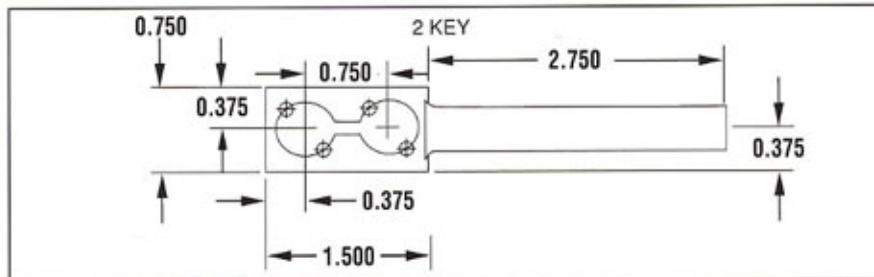
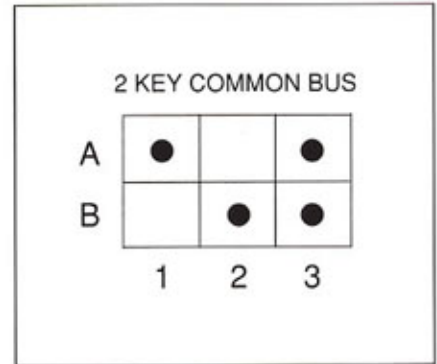
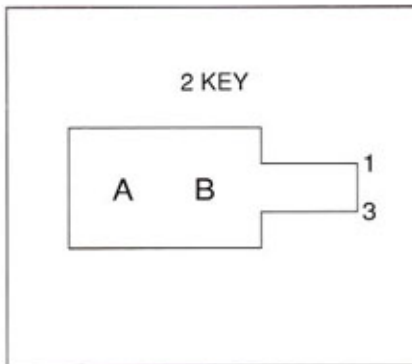

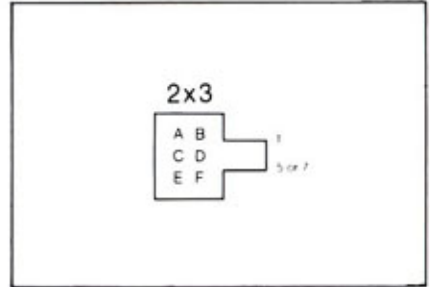
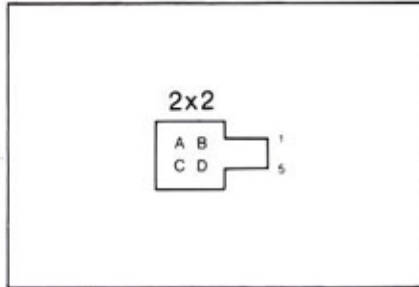
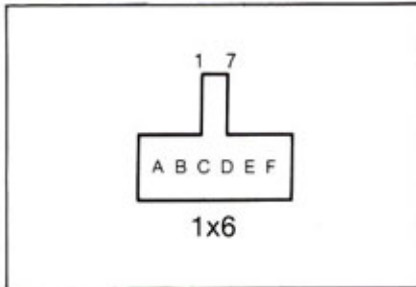
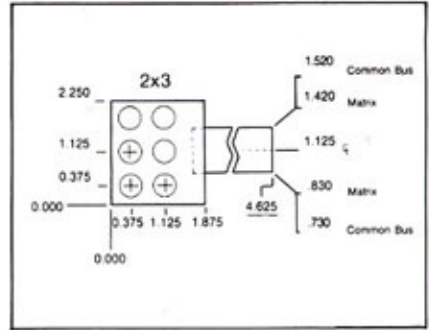
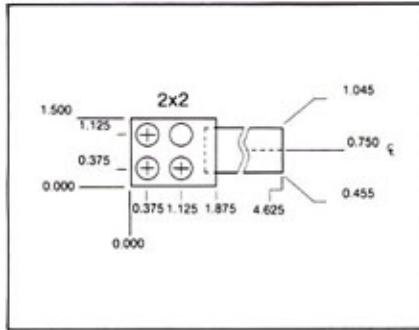
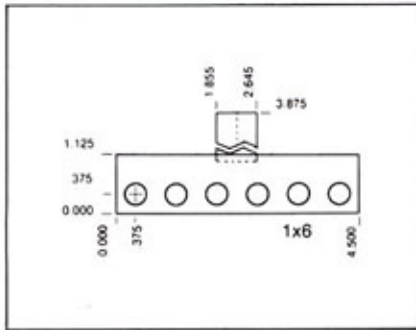

1x6

| Key | Track No. |
|-----|-----------|
| A | 1 4 |
| B | 2 4 |
| C | 3 4 |
| D | 5 4 |
| E | 6 4 |
| F | 7 4 |

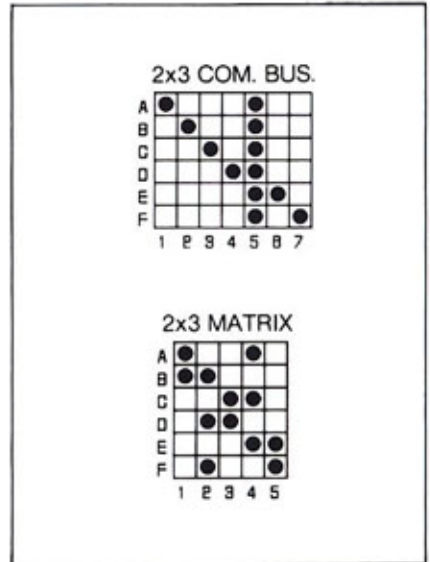
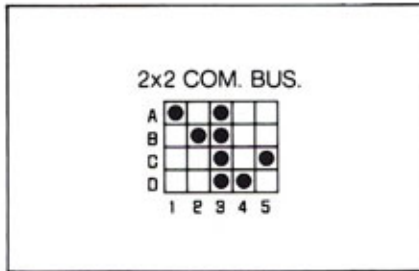

Catalog Numbers

| Termination* | 1 Key | 2 Key | 1 X 2 common | 1 X 4 common | 1 X 5 common | 1 X 6 common | 2 X 2 common | 2 X 3 common | 2 X 3 matrix |
|-------------------|-------|-------|--------------|--------------|--------------|--------------|--------------|--------------|--------------|
| Without Connector | 54892 | 54902 | 54902 | 54082 | 54122 | 54182 | 54422 | 54442 | 54452 |
| With Connector | 54894 | 54904 | 54904 | 54084 | 54124 | 54184 | 54424 | 54444 | 54454 |

*See P. 3 for more information.

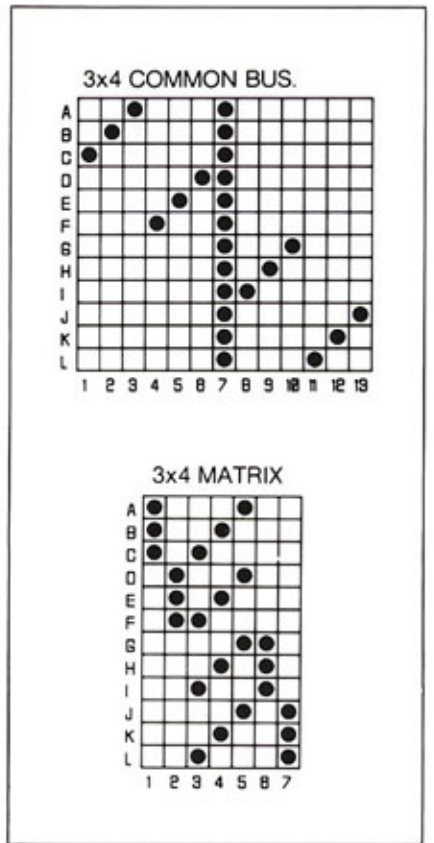
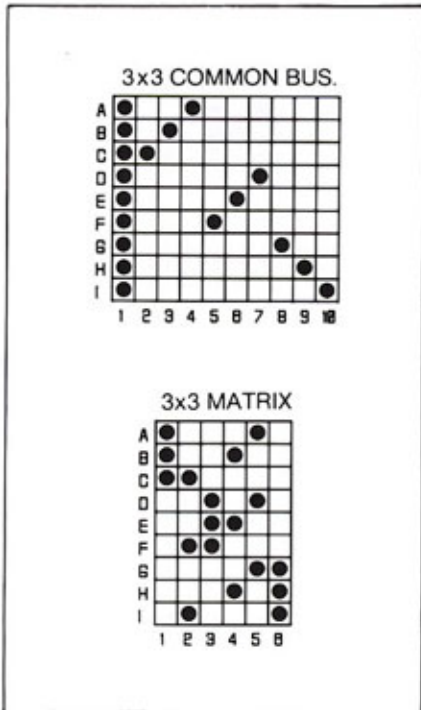
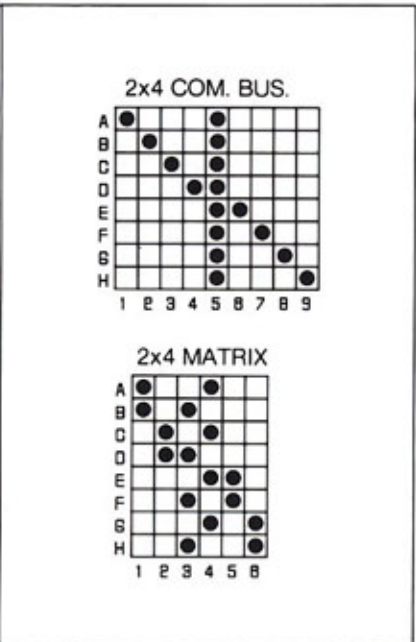
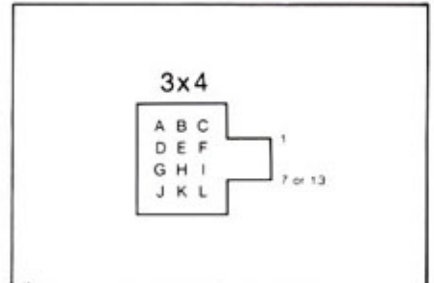
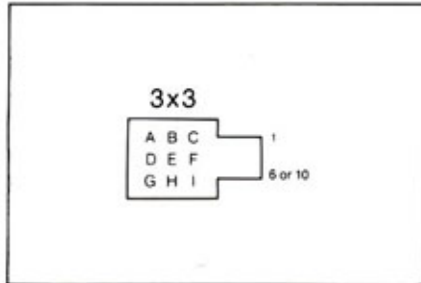
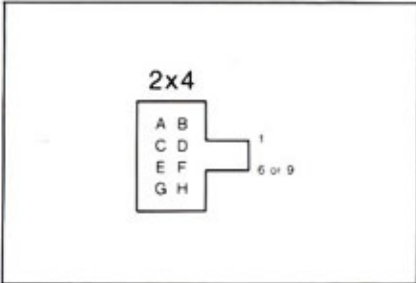
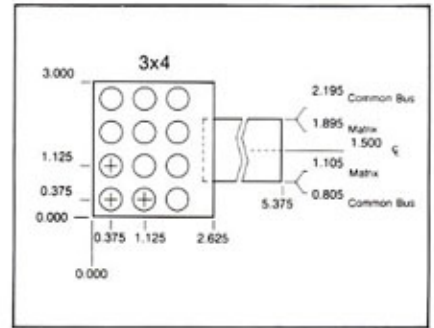
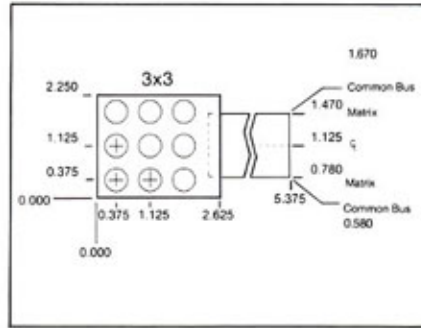
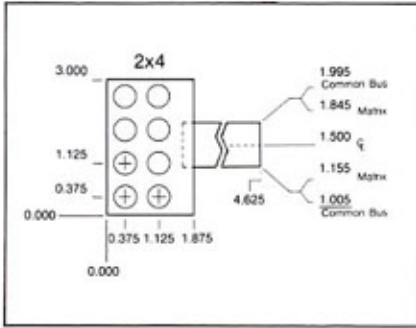

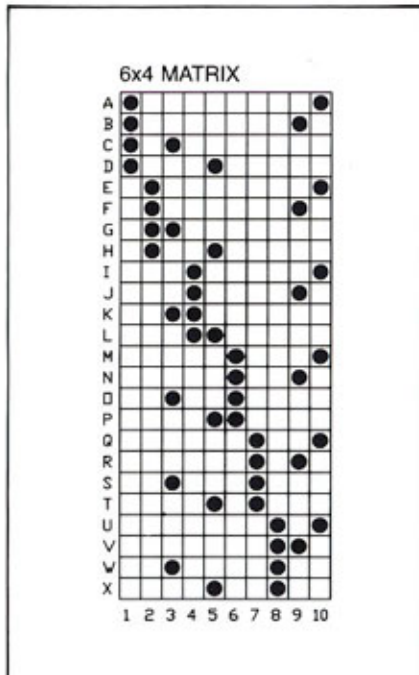
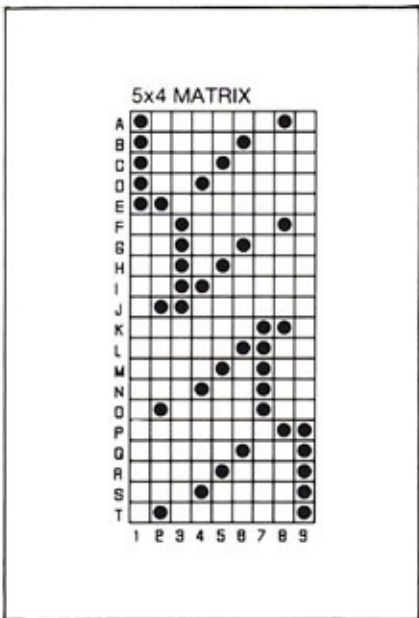
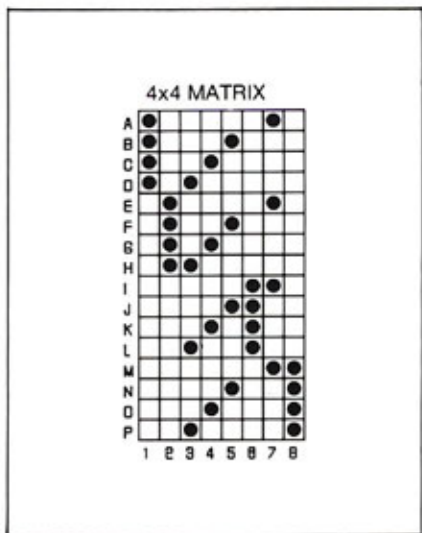
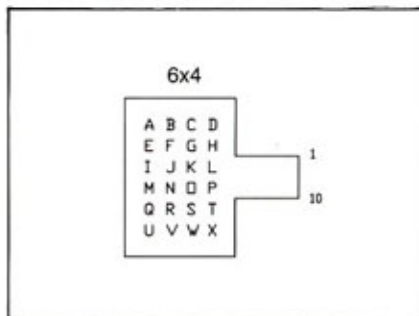
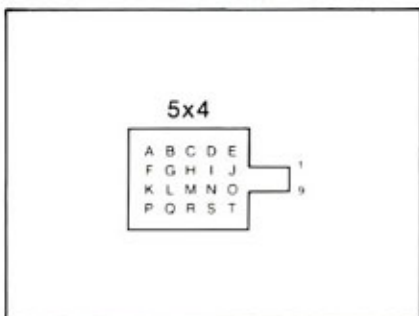
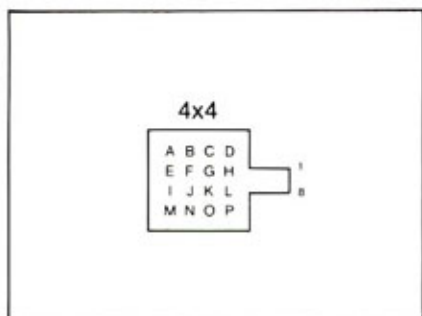
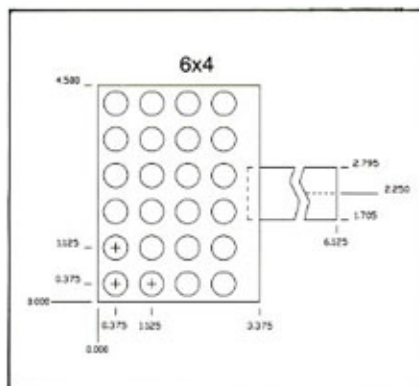
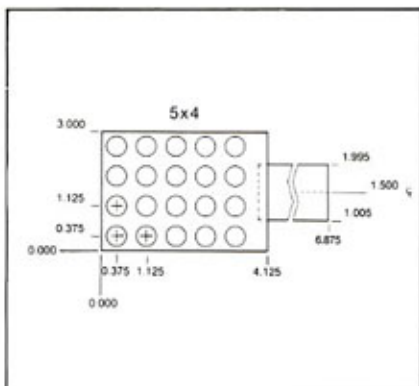
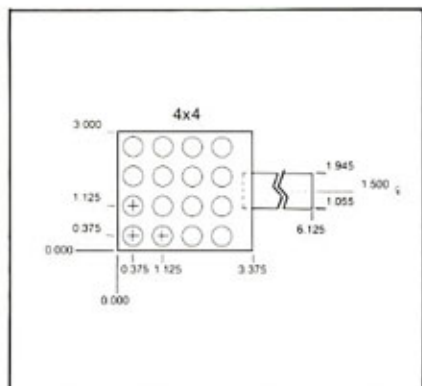

Catalog Numbers

| Termination* | 2x4 common | 2x4 matrix | 3x3 common | 3x3 matrix | 3x4 common | 3x4 matrix | 4x4 matrix | 5x4 matrix | 6x4 matrix |
|-------------------|---------------|---------------|---------------|---------------|---------------|---------------|---------------|---------------|---------------|
| Without Connector | 54462 | 54472 | 54602 | 54612 | 54642 | 54652 | 54812 | 55212 | 54832 |
| With Connector | 54464 | 54474 | 54604 | 54614 | 54644 | 54654 | 54814 | 55214 | 54834 |

*See P. 3 for more information.

Xymox is a leading manufacturer of stock and custom designed membrane switches and Integrated Membrane Switch Modules that include membrane switches, PCB assemblies, elastomers, electronic displays and enclosures.



PROVIDING TOTAL CUSTOMER SATISFACTION IN INTERFACE TECHNOLOGY PRODUCTS SINCE 1979

*For the name of the Xymox distributor nearest you call
1-800-TO-XYMOX (869-9669)*

9099 W. Dean Rd., Milwaukee, WI 53224 USA
Phone 414-362-9000 Fax 414-362-9090