

HIGH-SPEED CABLE

INTERCONNECT SOLUTIONS GUIDE

HIGH-SPEED CABLE SOLUTIONS

SAMTEC FLYOVER[®] ARCHITECTURE

Improves Signal Integrity & Reach at Higher Data Rates

In-House High Level Design & Engineering Support

Full System Signal Integrity Expertise



FLEXIBILITY & CUSTOMIZATION

Mix & Match Connector End Options

Extensive Customization Capabilities

Modular Backplane Flexibility



MANUFACTURING & CAPABILITIES

R&D/Manufacturing of Precision Extruded Cable & Next Gen RF Cable in Several Global Locations

Multiple Proprietary Ultra-High Performance Cable Technologies

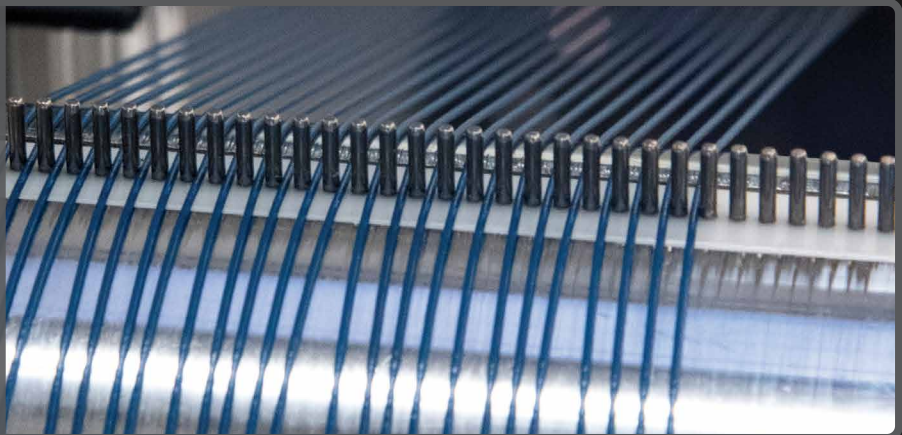

TABLE OF CONTENTS

HIGH-SPEED CABLE OVERVIEW	4-5
--	-----

FLYOVER® SYSTEMS

Flyover® Technology	6-7
Panel Assemblies	8-9
Mid-Board Assemblies	10-13
Backplane Assemblies	14-15

HIGH-SPEED CABLE SYSTEMS

Mix-and-Match Assemblies	16-17
Customized Assemblies	18-19
Eye Speed® Cable Specifications, Testing & System Optimization	20-21

OPTICAL SYSTEMS	22-23
------------------------------	-------

RF SOLUTIONS	24-25
---------------------------	-------

INNOVATION, EXPERTISE & SUPPORT

Technology & Global Manufacturing Capabilities	26
Evaluation & Development Kits	27
Sudden Service® Online Tools & Resources	28-29
Integration Leads to Innovation / Silicon-to-Silicon™ Solutions	30-31

HIGH-SPEED CABLE PRODUCT OVERVIEW



FLYOVER® SYSTEMS | 6-15

224 Gbps PAM4 EXTREME PERFORMANCE | INDUSTRY'S HIGHEST DENSITY | ASIC ADJACENT & ON-PACKAGE
CABLE-TO-CABLE, CABLE-TO-BOARD & CABLE-TO-PANEL | ULTRA LOW SKEW & ULTRA PERFORMANCE TWINAX CABLE



HIGH-SPEED CABLE ASSEMBLIES | 16-19

MICRO COAX & TWINAX CABLE | MIX-AND-MATCH END OPTIONS | ARRAYS, GROUND PLANE & EDGE CARD SYSTEMS
 PCIe® 2.0/3.0/4.0/5.0 | EDGE RATE® RUGGED, HIGH-SPEED CONTACTS

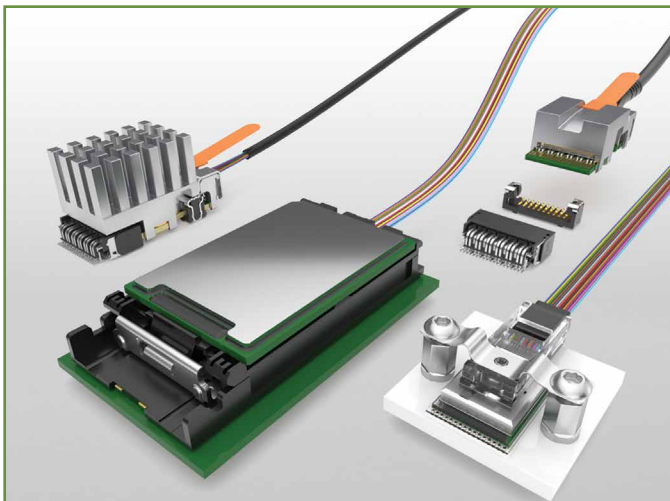

OPTICAL SYSTEMS | 22-23

FUTURE PROOF | EXTREME ENVIRONMENT | PCIe® 3.0/4.0
 RUGGED OPTICAL TRANSCEIVERS | NEXT GEN 112 Gbps

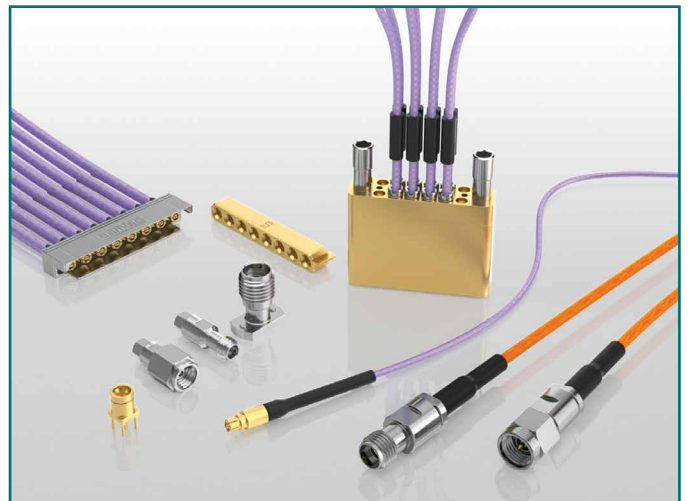

RF SOLUTIONS | 24-25

TESTING TO 90 GHz | PRECISION RF CABLES & CONNECTORS
 FLEXIBLE WAVEGUIDES | NEXT GEN RF CABLE

FLYOVER[®] TECHNOLOGY

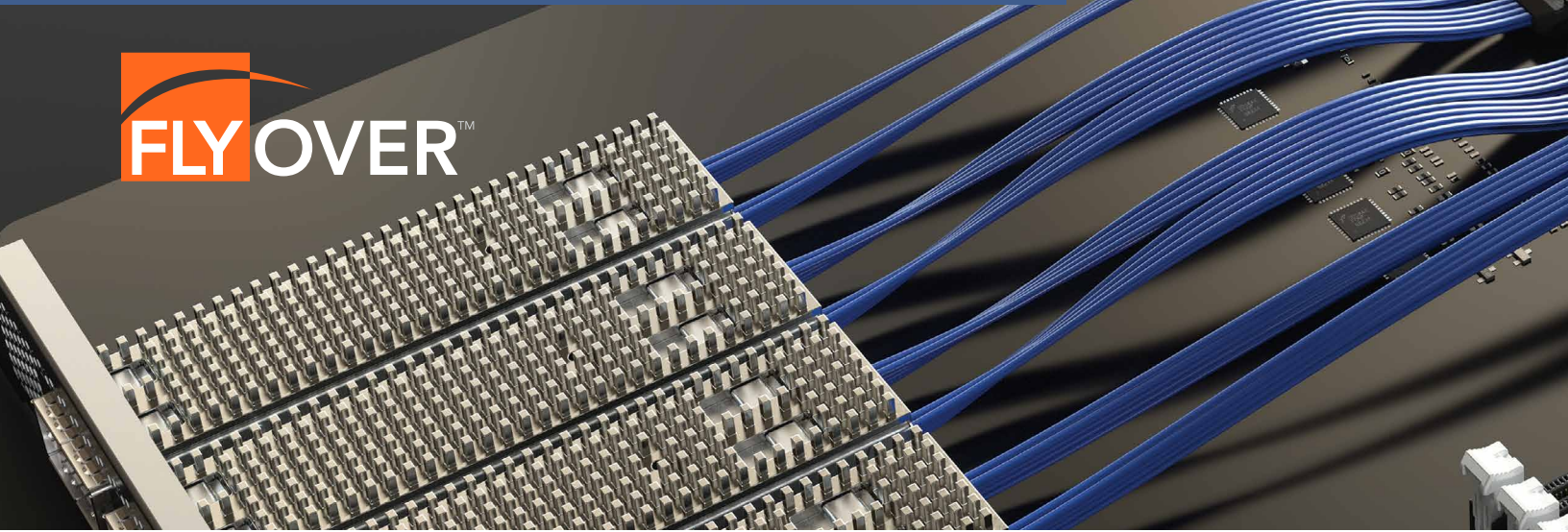

THE PROBLEM

PCB REACH AT NEXT GEN SPEEDS

As bandwidth requirements rapidly increase, effectively managing heat and routing signals through lossy PCBs, vias and other components have become complex challenges.

BANDWIDTH VS. TRADITIONAL & HIGH-SPEED MATERIALS

(Comparison at -5 dB Insertion Loss Point)

	FR408	MEGTRON 6	MICRO TWINAX
PAM4 56 Gbps	0.0"	up to 2"	36"+
PAM4 112 Gbps	0.0"	0.0"	18"+

THE SOLUTION

SAMTEC FLYOVER[®] SYSTEMS

Samtec Flyover[®] design breaks the constraints of traditional signaling substrate and hardware offerings, resulting in a cost-effective, high-performance and heat efficient answer to the challenges of 56 Gbps bandwidths and beyond.

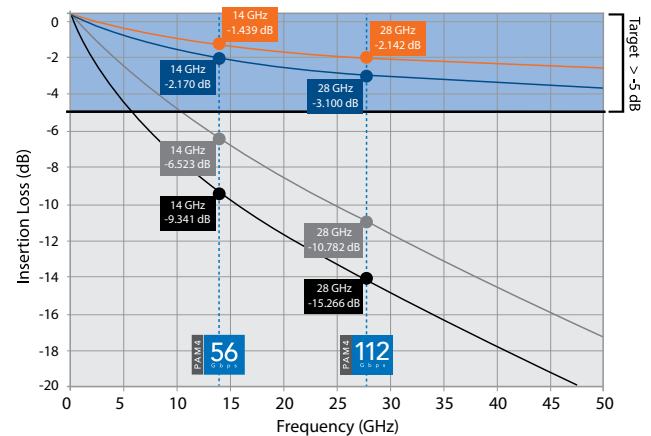

■ 30 AWG 100 Ω Eye Speed[®] Low Skew Twinax Cable
■ 34 AWG 100 Ω Eye Speed[®] Low Skew Twinax Cable
■ Low Loss Backplane PCB trace, 5.7 mil wide, 8.3 mil space
■ Ultra Low Loss Backplane PCB trace, 5.7 mil wide, 8.3 mil space
*Loss values based on 12" trace.

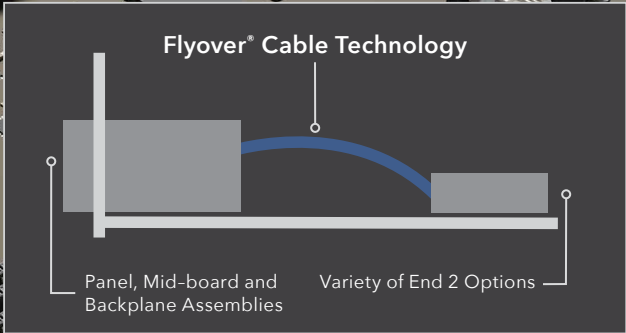
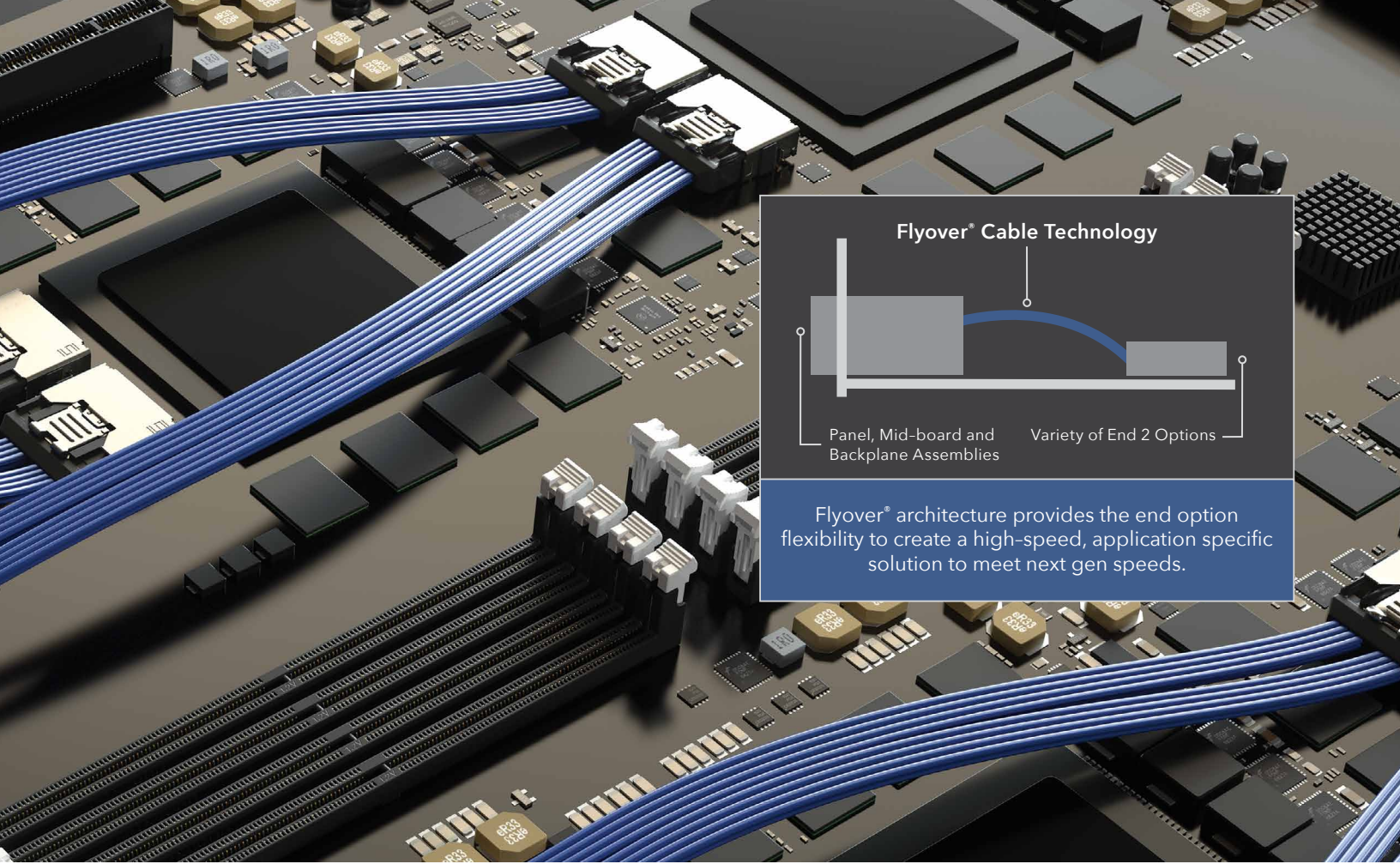

Flyover® architecture provides the end option flexibility to create a high-speed, application specific solution to meet next gen speeds.

EYE SPEED® TWINAX CABLE TECHNOLOGY

- Ideal for 28-112+ Gbps applications
- Tight coupling between signal conductors
- Ultra low skew twinax < 3.5 ps/meter
- 40% smaller cross-sectional area (Thinax™)
- See page 20-21 for cable specifications
- In Development: Eye Speed® AIR foamed twinax for significantly improved signal integrity and even lower intra-pair skew

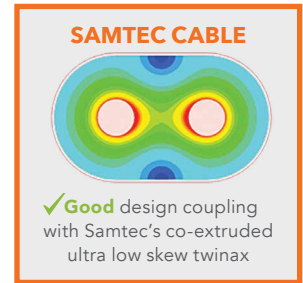
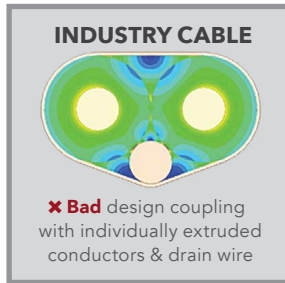

PERFORMANCE & COST ADVANTAGES

- 28-56 Gbps NRZ & Beyond
- Simplified Board Layout
- Fewer PCB Layers
- Less Expensive PCB Materials
- Eliminate Expensive Re-timers

NRZ	PAM4	NRZ	PAM4
28 Gbps	56 Gbps	56 Gbps	112 Gbps

SUPPORT

Fully integrated technology teams provide support to enable full system optimization from Silicon-to-Silicon™. See page 26 for information about Samtec's High-Speed Cable Plants.

THERMAL IMPROVEMENT

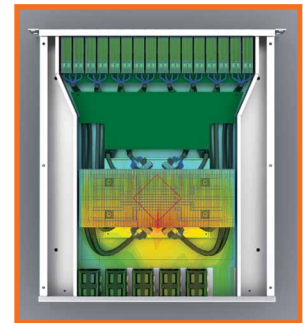
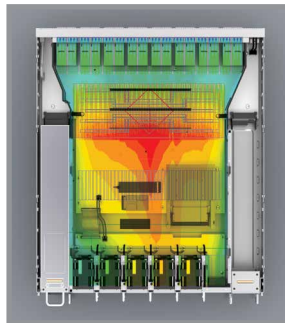

Standard Network Switch vs. Samtec Flyover® Technology

FLYOVER® PANEL ASSEMBLIES

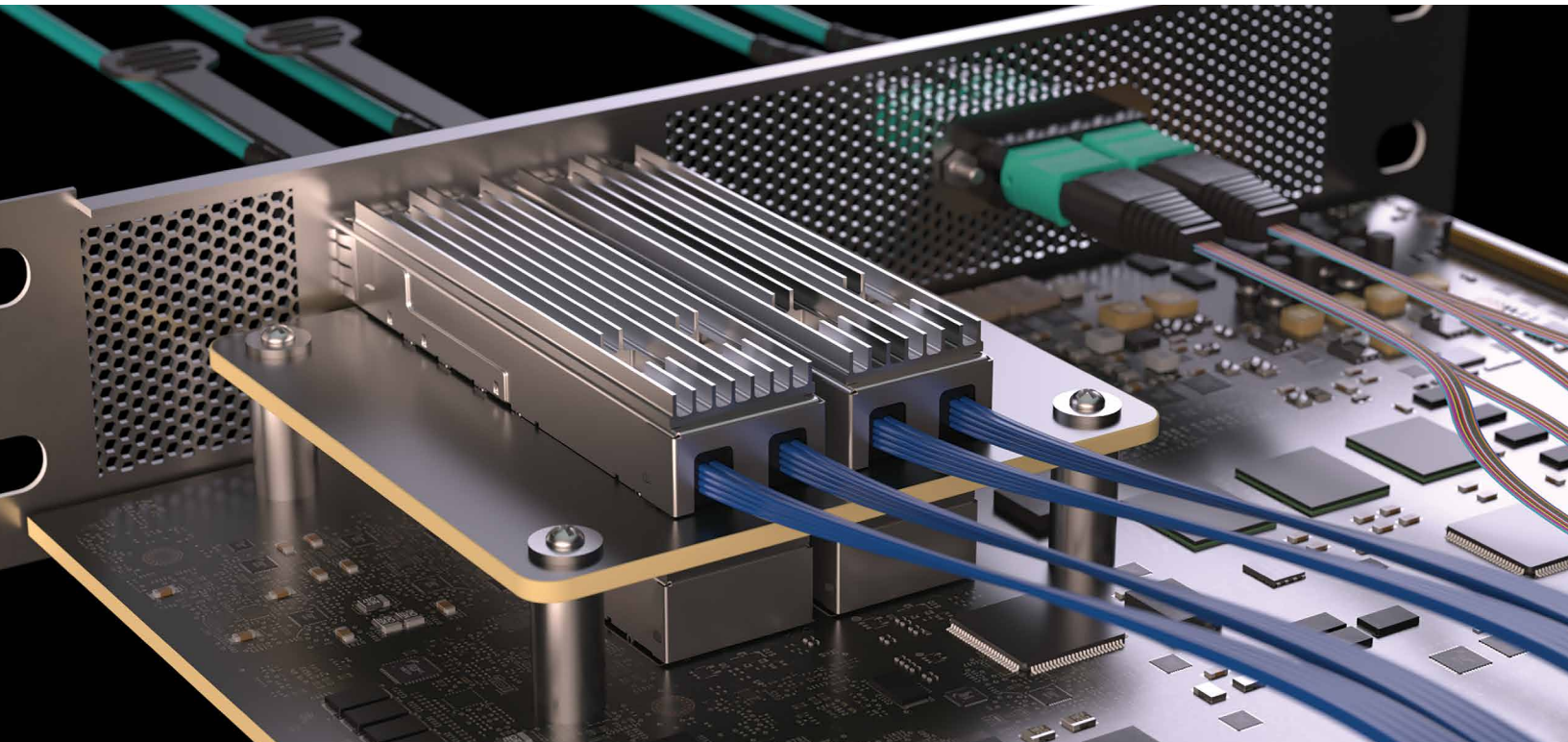

FLYOVER® QSFP SYSTEMS

- Up to 800 Gbps PAM4 aggregate data rate (112 Gbps PAM4 per channel)
- 4 channels (x4 bidirectional, 8 differential pairs) or 8 channels (x8 bidirectional, 16 differential pairs)
- Double density versions feature belly-to-belly mating for maximum density (FQSFP-DD, FQSFP-D8)
- Multiple heat sink options for optimal dissipation
- Variety of end 2 options including AcceleRate®, NovaRay®, Si-Fly™, FireFly™ and ExaMAX®
- Evaluation Kits available, see page 27 or visit samtec.com/kits
- Additional front panel ports in development: SFP112, OSFP200



NRZ	PAM4
56 Gbps	112 Gbps

FQSFP-D8

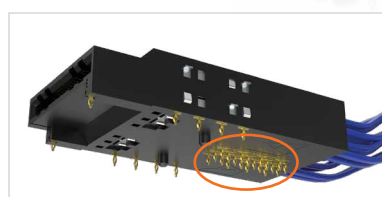
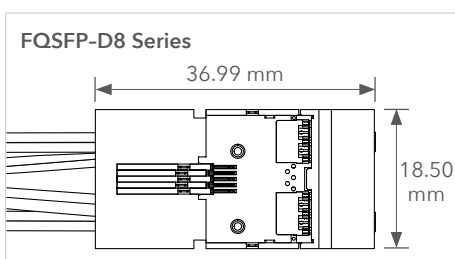

Sideband signals are routed through press-fit contacts for increased airflow

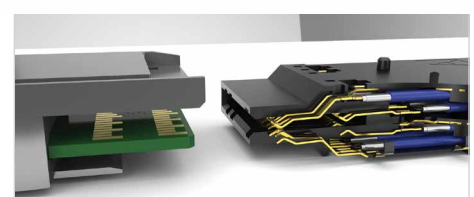

High-speed contacts directly soldered to Eye Speed® ultra low skew twinax

NOVARAY® I/O EXTREME PERFORMANCE SYSTEM

- Up to 3,584 Gbps PAM4 aggregate data from the IC package to the panel and beyond
- No heat sinks required for panel space savings
- 16 and 32 differential pair configurations
- Accommodates PCIe® x4 or x8 plus sidebands
- 28 or 34 AWG (external) and 34 AWG (internal) ultra low skew twinax
- Cable-to-cable bulkhead panel connection using Flyover® cable technology
- Multiple end 2 high-speed connector options including AcceleRate®, NovaRay® and Si-Fly™

NOVARAY® I/O



NVACP/NVACE/NVC

PAM4
112
Gbps

PCI EXPRESS®
6.0 Capable

TARGETED CONFIGURATIONS	AGGREGATE DATA RATE
8 Pair (in development)	896 Gbps
16 Pair	1792 Gbps
32 Pair	3584 Gbps
x4 (8 Pair + PCIe® Sidebands)	512 Gbps
x8 (16 Pair + PCIe® Sidebands)	1024 Gbps

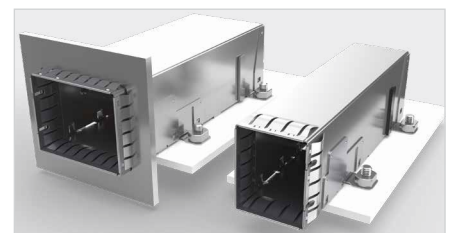

Right-angle to front panel available for design flexibility

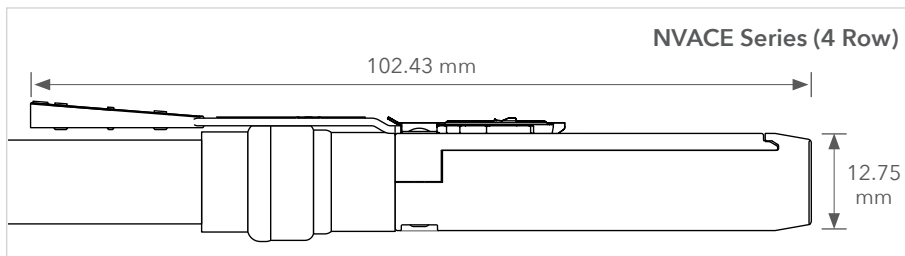

Roadmap: NovaRay® I/O in a rugged 38999 shell & salt fog resistant to 48 hours

PCI-SIG®, PCI Express® and the PCIe® design marks are registered trademarks and/or service marks of PCI-SIG.

ExaMAX® I/O SHIELDED CABLE SYSTEM

- Fully shielded external cable and cage for EMI protection
- Rugged pull latch for mating/unmating
- Cage designed for use with ExaMAX® right-angle board connector (EBTM-RA)
- 30 and 34 AWG ultra low skew twinax
- 24 to 72 pairs (4 and 6 pairs; 6, 8, 10 and 12 columns)
- Roadmap: cable-to-cable bulkhead panel connection for increased performance to 112 Gbps PAM4

ExaMAX®

PAM4
56
Gbps



EBCE/EBTC

ExaMAX® is a registered trademark of AFCI.

FLYOVER[®]

MID-BOARD ASSEMBLIES

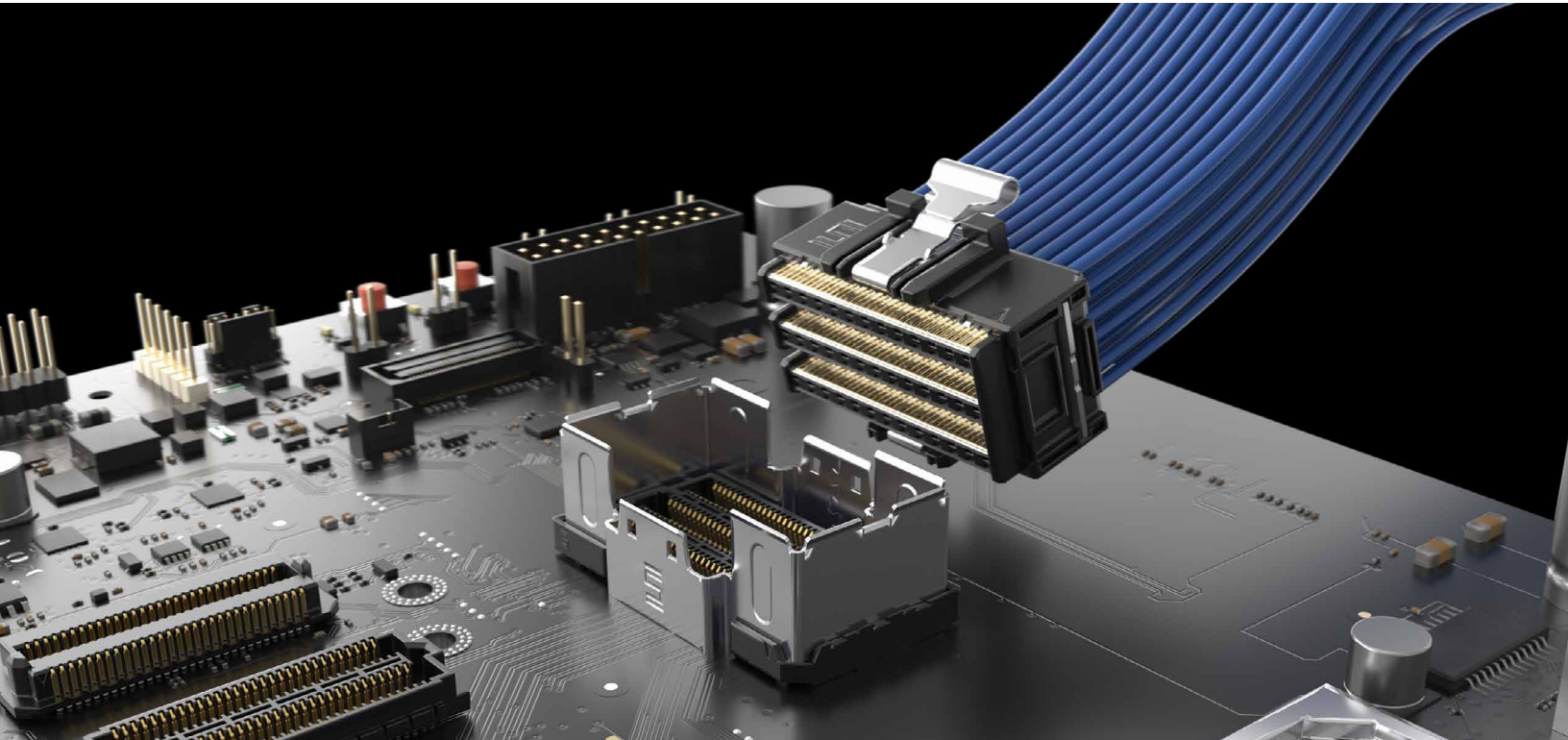

NOVARAY[®] EXTREME HIGH-SPEED, HIGH-DENSITY CABLE

- Industry leading aggregate data rate density – 2x the data rate in 60% of the space
- Proprietary pin to ground configuration enables very low crosstalk (to 40 GHz) and very tight impedance control
- Two reliable points of contact guaranteed
- BGA attach for density and optimized trace breakout region
- Evaluation Kits available, see page 27 or visit samtec.com/kits

NRZ	PAM4
56 Gbps	112 Gbps

NOVARAY[®]

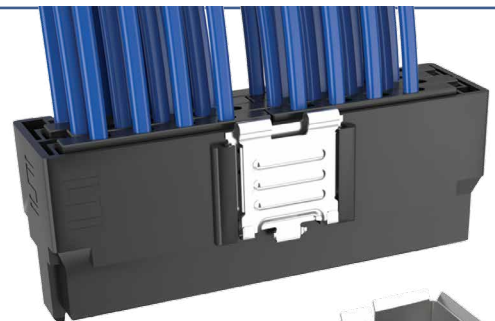
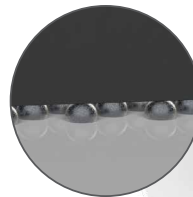

NVAC/NVAM-CT

AGGREGATE DATA RATE (NRZ)						
448 Gbps	672 Gbps	896 Gbps		1344 Gbps	1792 Gbps	4032 Gbps*
1 Bank				2 Bank		3 Bank*
2 Row	3 Row	4 Row	2 Row	3 Row	4 Row	6 Row*
8 Pairs	12 Pairs	16 Pairs		24 Pairs	32 Pairs	72 Pairs*

*In development

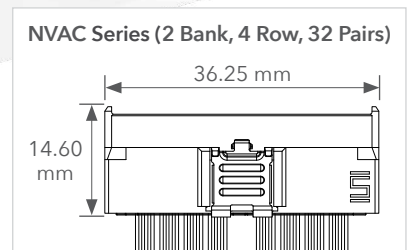

ACCELERATE® HP EXTREME DENSITY SYSTEM

- Industry's highest density 112 Gbps PAM4 cable-to-board system
- Supports today's 256-channel chip and tomorrow's 512-channel chip
- Staggered row-to-row spacing of 2.2 mm x 2.4 mm allows adequate routing lanes for optimized traces; 0.635 mm contact pitch
- 32 to 72 differential pairs; up to 96 pairs in development
- Eye Speed® 34 AWG ultra low skew twinax cable
- BGA solder ball attach for simplified processing
- Right-angle shielded mating connector in development (APF6-RA)

ACCELERATE®HP

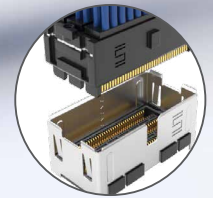
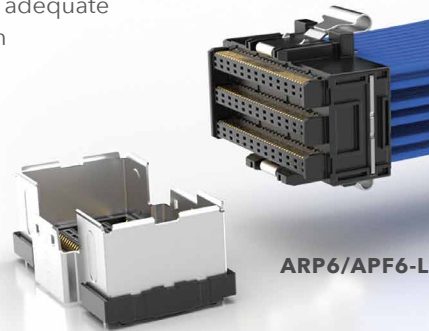

Locking available for maximum density

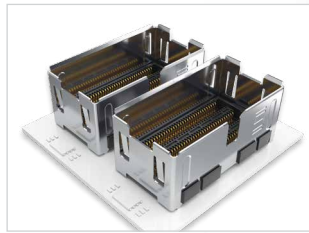
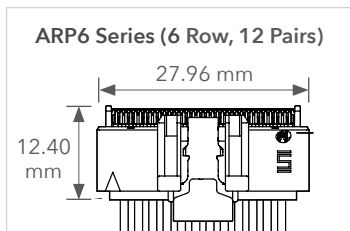

NRZ	PAM4
56 Gbps	112 Gbps

35 mm x 35 mm footprint holds two 72 differential pair connectors (144 total pins)

ACCELERATE® HP GEN 2 ON-PACKAGE SYSTEM

- Samtec is the first to achieve a direct-to-chip package solution with the industry's highest density 112 Gbps PAM4 interconnect
- Double the density in the same Gen 1 footprint; up to 144 differential pairs
- 182 differential pairs per square inch
- Staggered row-to-row spacing; 0.635 mm contact pitch
- Eye Speed® Thinax™ ultra performance twinax cable (see page 20 for information)
- Vertical cable application provides the highest footprint density
- 2-piece system for high reliability and thermal performance required for co-packaged solutions
- Roadmap: Single-ended signaling micro coax cable assembly, and mixed wafer technology with micro coax and Thinax™ cable

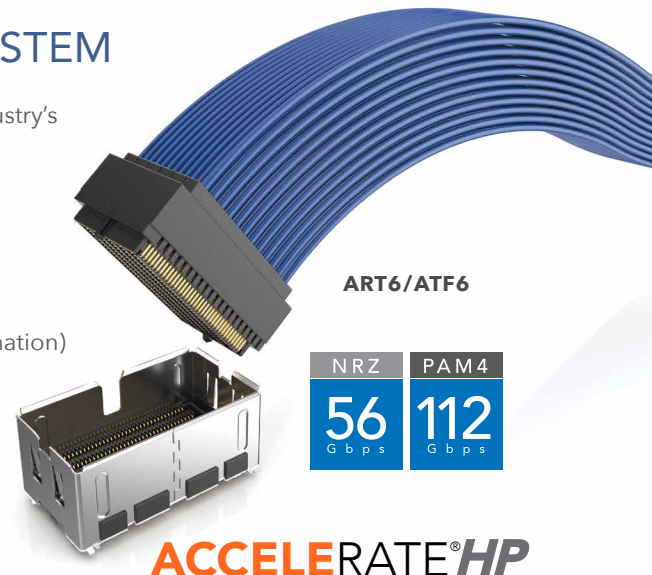

NRZ	PAM4
56 Gbps	112 Gbps

ACCELERATE®HP

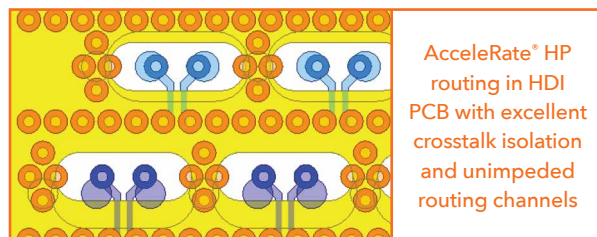
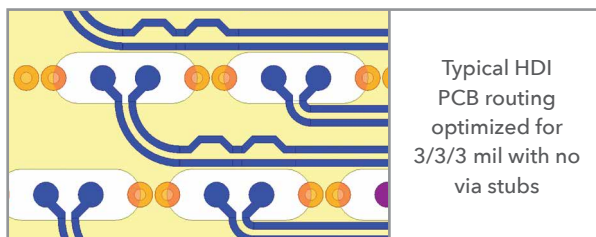



ACCELERATE® SLIM, DIRECT ATTACH SYSTEM

- Slimmest cable assembly in the industry – 7.6 mm width
- 8, 16 and 24 differential pair configurations in a high-density 2-row design; 72 pairs in development
- PCIe® 5.0 capable
- Contacts directly soldered to the cable improves signal integrity by eliminating the transition board and its variability
- Eye Speed® 34 AWG ultra low skew twinax cable
- Rugged metal latching and shielding
- “Reversed Polarity” pinout option for reduced Far-End Crosstalk
- Evaluation Kit available, see page 27 or visit samtec.com/kits

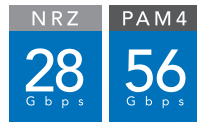

ACCELERATE®



ARC6/ARF6

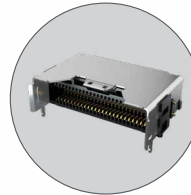

Right-angle board mate available

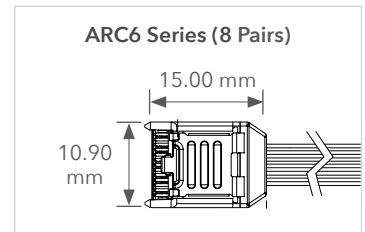

ACCELERATE® MINI EXTREME PERFORMANCE SYSTEM

- Design flexibility as an End 2 option for Flyover® assemblies
- One or two differential pairs
- Eye Speed® 34 AWG Thinax™ ultra performance twinax cable (see page 20 for more information)
- Vertical and right-angle mating board connector

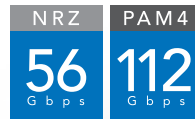

ACCELERATE® mini

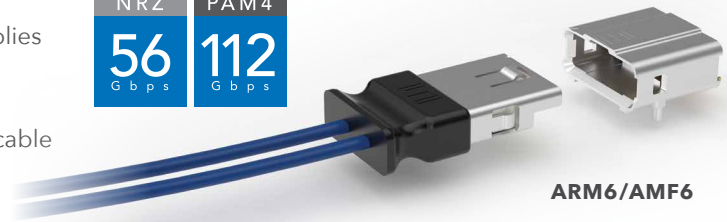

ARM6/AMF6

GENERATE™ HIGH-SPEED EDGE CARD SYSTEM

- Compatible with SFF-TA-1002 (1C, 2C, 4C & 4C+)
- Surpasses PCIe® 4.0 and 5.0 performance requirements
- Edge Rate® contacts optimized for signal integrity performance
- Vertical or right-angle cable launch
- Mates with Generate™ 0.60 mm pitch high-speed edge card socket (HSEC6)
- Rugged metal latching system

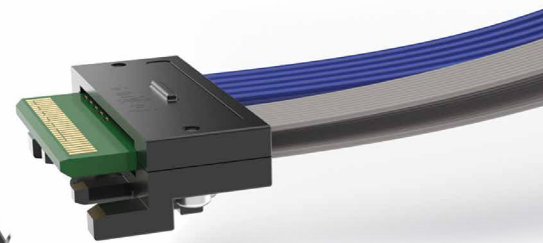
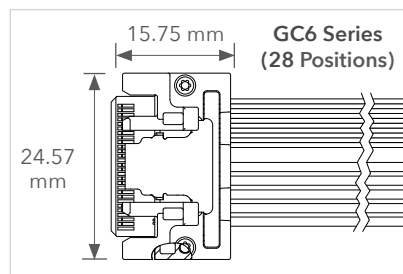

GC6/HSEC6

GENERATE™

SI-FLY™ LOW PROFILE CABLE SYSTEM

- Up to 16 pairs in an extremely low 3.8 mm profile for placement adjacent to the IC package, under heat sinks or other cooling hardware
- 112 Gbps PAM4 per lane enabling 25.6 TB aggregate with a path to 51.2 TB
- High-density 8 or 16 pairs for routing 4 or 8 channels
- Eye Speed® 34 AWG ultra low skew twinax cable
- 8.4 mm minimum height required for mating
- Evaluation Kit available, see page 27 or visit samtec.com/kits

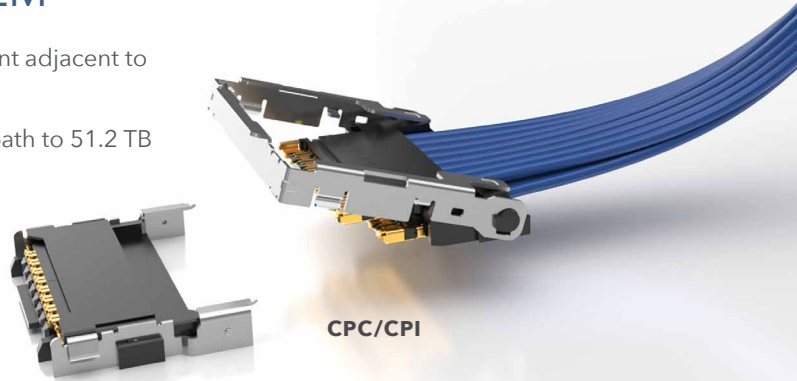

CPC/CPI

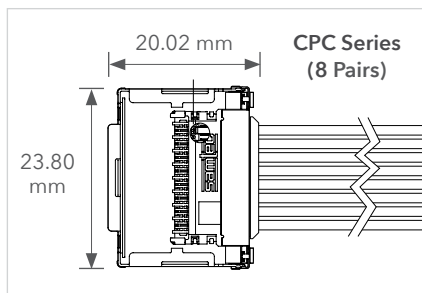

Incredibly low 3.8 mm mated profile



NRZ	PAM4
56 Gbps	112 Gbps

SI-FLY™ HIGH-DENSITY ON-PACKAGE SYSTEM

- Vertically launched cables for the highest density package
- 64 pairs in an incredibly small 13 mm x 13 mm footprint
- 245 differential pairs per square inch
- 0.53 mm (Signal-Ground) and 0.40 mm (Signal-Signal) contact pitch; 1.25 mm row-to-row pitch
- Designed for High Density Interconnect (HDI) and package substrates
- Eye Speed® Thinax™ ultra performance twinax cable (see page 20 for additional information)

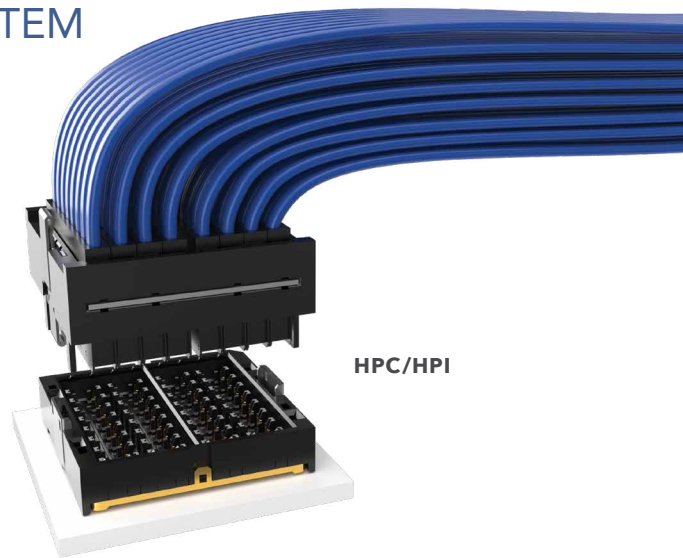

HPC/HPI



PAM4
224 Gbps

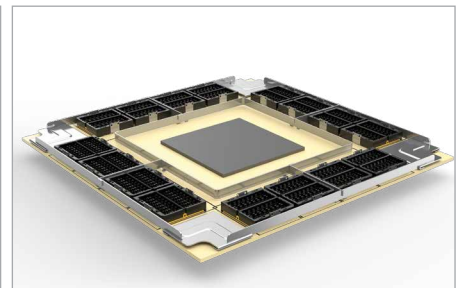
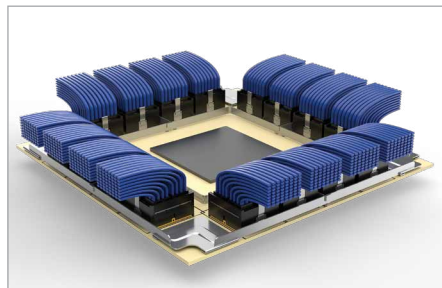
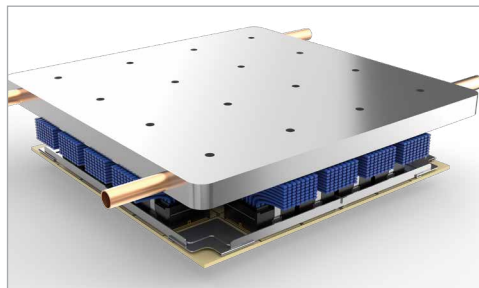

Ultra-high density solution for co-packaged applications.

FLYOVER[®] BACKPLANE CABLES

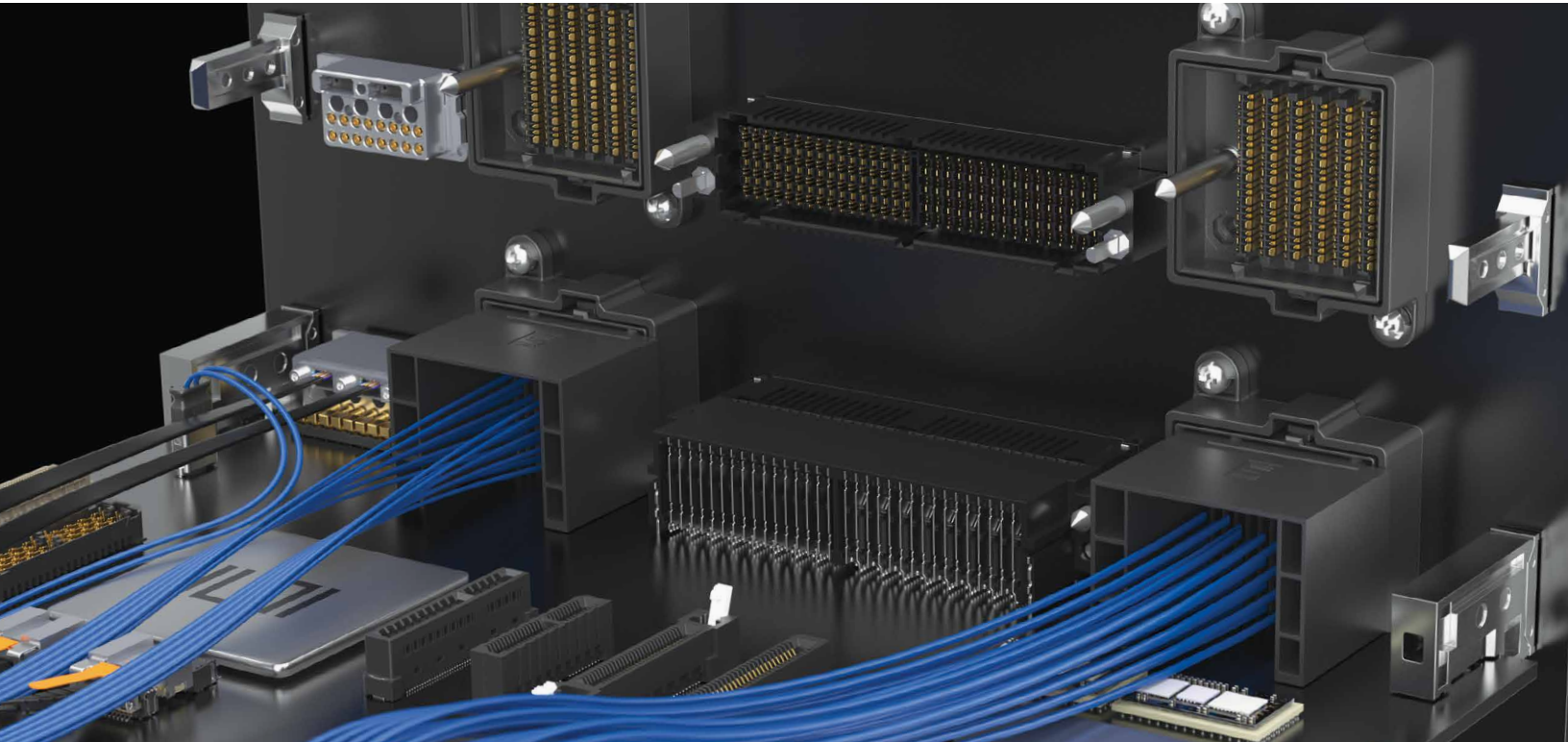

NOVARAY[®] MICRO RUGGED BACKPLANE SYSTEM

- True 112 Gbps PAM4 signal integrity with Flyover[®] support
- Cable-to-board, cable-to-cable, board-to-board
- Configurable signal banks for design flexibility
- Offset footprint for optimal signal integrity performance
- Reliable two points of contact for stub free mating
- Large continuous ground blades between and surrounding the differential pairs eliminates resonances
- Optional guidance and keying for blind mate

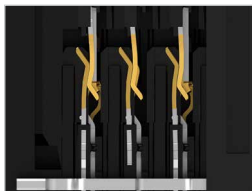

Precision Insert Molded
Contact System

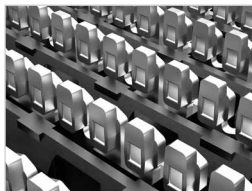

Solder Charge Termination
for Higher Densities

PAM4
112
Gbps

NOVARAY[®]

Supports
Blind Mate
Applications

NVCF/NVBF/
NVBM-RA

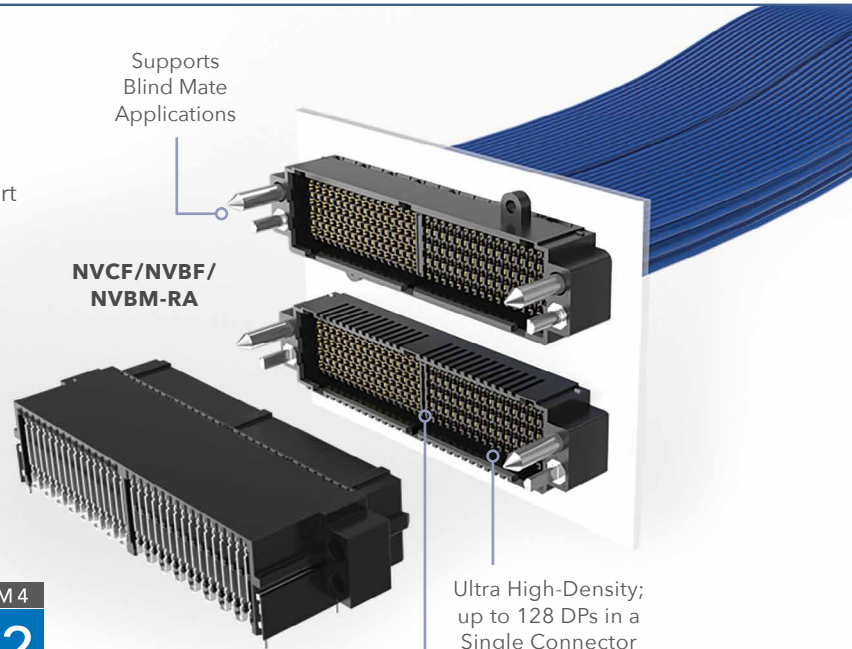

Ultra High-Density;
up to 128 DPs in a
Single Connector

Single-Ended or
Differential Pair
Wafers

ExaMAX® HIGH-SPEED BACKPLANE SYSTEM

- Cable-to-cable, cable-to-board, mid-board and panel applications
- Highly customizable with modular flexibility
- Reduced costs due to lower PCB layer counts
- 4 and 6 pairs; 4-16 columns
- Integrated guidance and keying options
- Multiple end 2 options available
- Evaluation Kit available, see page 27 or visit samtec.com/kits

NRZ	PAM4
56	112
Gbps	Gbps

ExaMAX®



EBCF/EBDM-RA

Cable-to-DMO
(Direct Mate Orthogonal)

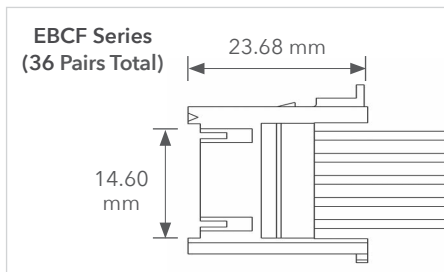

ExaMAX® I/O Cable System also available (see page 9)



Roadmap: 8 Pairs for Greater Design Flexibility

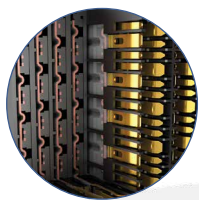

Staggered Differential Pairs Provide Higher Data Rates

Designed for Blind-Mate Systems

Industry's Lowest Mating Force with Excellent Contact Normal Force

Two Reliable Points of Contact with a 2.4 mm Wipe

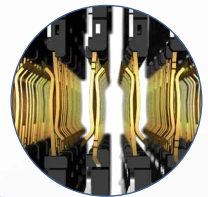

EBTF-RA

EBCB

EBCM

30 and 34 AWG Ultra Low Skew Twinax Cable Supports Various Cable Lengths

EBCF

Vertical and Right-Angle

Wafer Design Increases Isolation for Reduced Crosstalk and Includes One Sideband Signal per Column

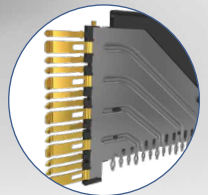

HIGH-SPEED CABLE ASSEMBLIES

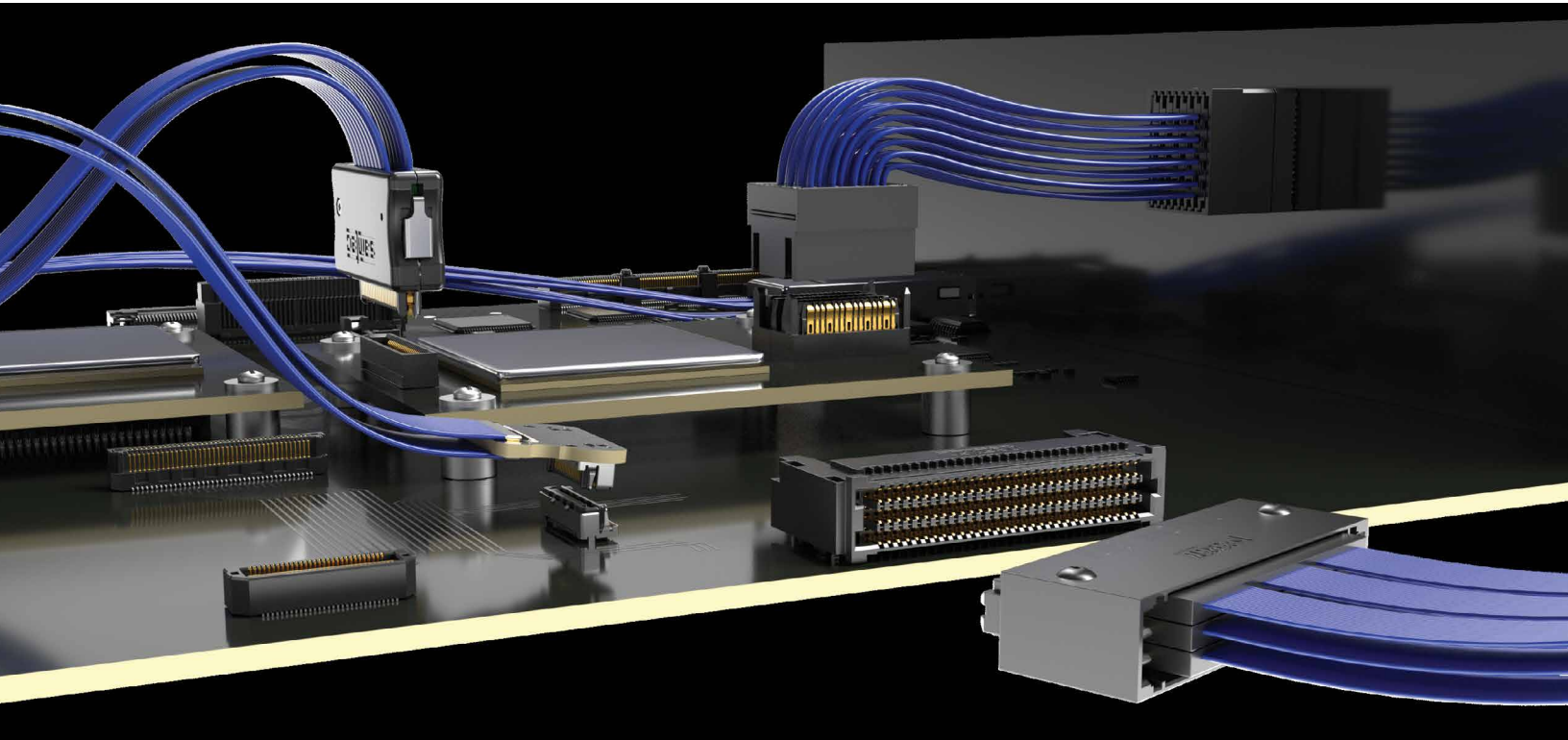

14
Gbps

MICRO COAX & TWINAX CABLE ASSEMBLIES

- Ability to mix-and-match end options for application-specific requirements with extensive customizing capabilities
- Single-ended 50 Ω & differential 100 Ω standards
- Rugged features and options including strain relief, plastic housings, screw downs, latches, locks, etc.
- Many non-cataloged standards available including 75 Ω micro coax and high-density twinax solutions



EYE[®]
SPEED
CABLE

EYE SPEED[®] CABLE TECHNOLOGY

- Excellent signal integrity performance with individual copper serve or braid shielding
- Stranded conductor for small bend radii and dynamic high flexing cycle applications
- Cost-effective ribbonizing eliminates discrete wires
- 26-38 AWG coax and twinax construction; 20 Ω , 50 Ω , 85 Ω & 100 Ω

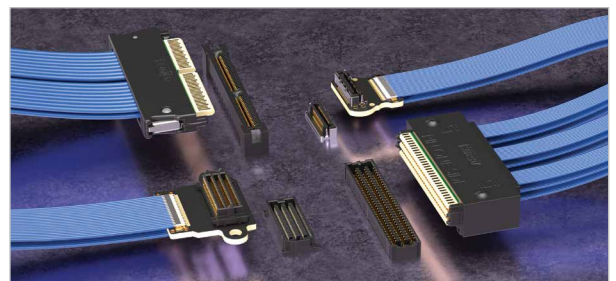

Samtec's Eye Speed[®] cable supports a wide variety of assemblies and applications

HIGH-DENSITY ASSEMBLIES

- 1.27 mm (SEAC) and 0.80 mm pitch (ESCA)
- 34 or 36 AWG coax; 32 AWG twinax
- Mates with SEARAY™ and SEARAY™ 0.80 mm arrays
- Optional rugged latching



GROUND PLANE ASSEMBLIES

- Integral power/ground plane
- 34 and 38 AWG coax; 30 AWG twinax
- 0.50 mm (HQCD/HQDP) and 0.80 mm pitch (EQCD/EQDP/EQRD)
- Mates with Q Series® and Q Rate® connectors

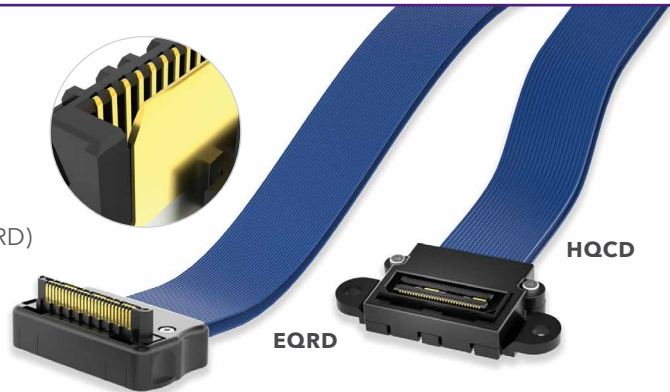

EDGE CARD ASSEMBLIES

- 30 AWG twinax (ECDP); mates with Generate™ 0.80 mm pitch edge cards (HSEC8)
- PCI Express® twinax assemblies support 3.0/4.0/5.0 data transfer rates (PCIEC)
- FireFly™ copper available as standard (14 Gbps), optimized (56 Gbps PAM4) and PCIe® 4.0; Evaluation Kit available, see page 27 or visit samtec.com/kits
- 34 AWG ultra low skew twinax (FEDP); mates with 0.50 mm pitch edge card (FCDP)



HIGH-SPEED ASSEMBLIES

- Ultra-micro hermaphroditic Razor Beam™ coax assemblies with rugged shielding (HLCD)
- 0.80 mm pitch Edge Rate® coax and twinax assemblies (ERCD, ERDP)
- 38 AWG coax & 30 AWG twinax assemblies



HIGH-SPEED CABLE

DESIGN FLEXIBILITY



ANY
high-speed
connector

ANY
break-out
configuration

ANY
high-speed
precision cable

... to create a solution for
any specific application.

HDR@samtec.com

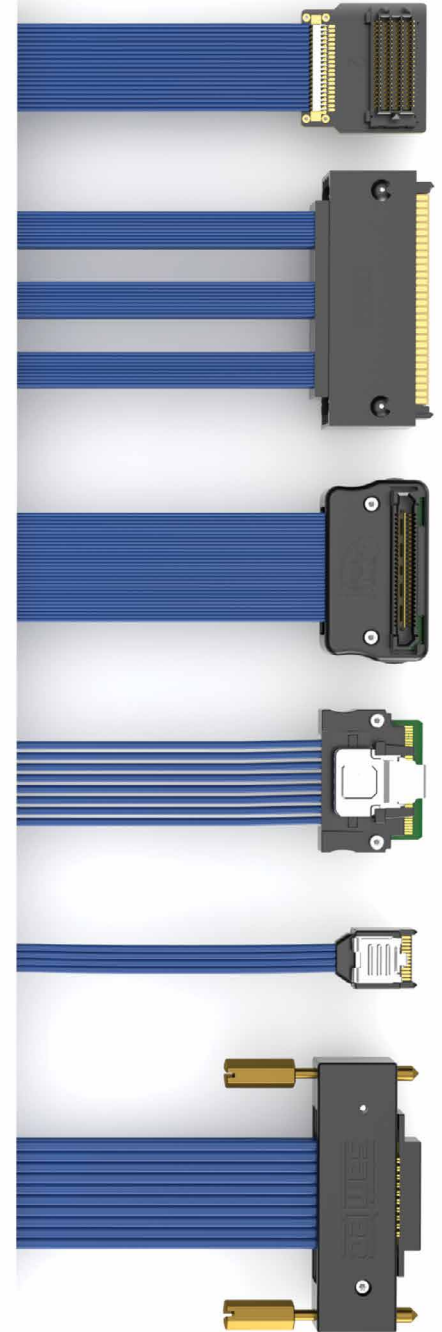

Visit samtec.com/custom for additional information.

WILLINGNESS, SUPPORT & EXPERTISE

Industry-Leading Customer Service

- Quotes and samples in 24 hours
- Prototype and processing assistance
- Dedicated Application Specific Product engineers and technicians

Flexible, In-House Manufacturing

- Global Operations, including multiple cable fabrication & assembly facilities
- Quick-turn samples and prototypes
- Custom & modified product support

Signal Integrity Expertise

- Industry-leading engineering support for high-performance system design
- Full system optimization assistance, including simulation, testing, analysis and evaluation

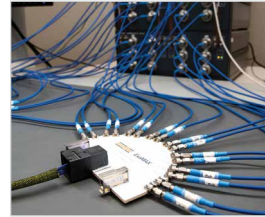
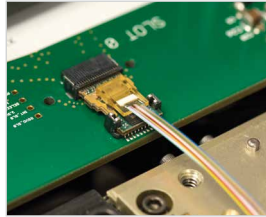
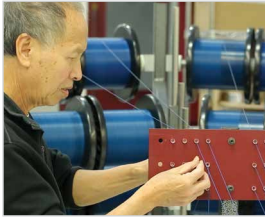

CUSTOMS & EXPRESS MODIFICATIONS

Samtec is able to support completely new and/or custom designs, as well as common simple modifications to cable assemblies and board-to-board products - often with low or no NRE charges, short lead times, quick-turn samples, and low or no MOQ's. Capabilities include:

- Contacts
- Bodies
- Stamping
- Ruggedizing features
- Wiring
- Molding
- Plating
- Polarization
- Packaging
- Labeling
- Ink printing
- Shielding modifications

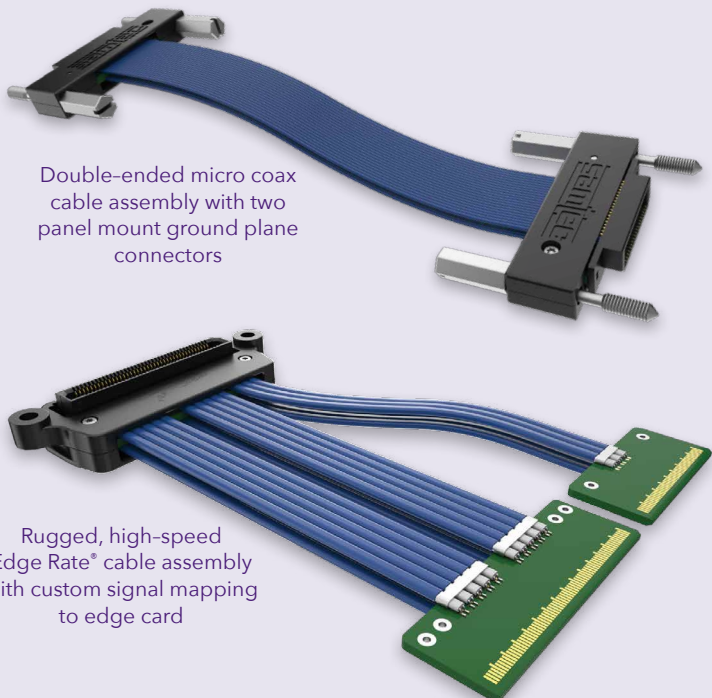

Double-ended micro coax cable assembly with two panel mount ground plane connectors

Rugged, high-speed Edge Rate[®] cable assembly with custom signal mapping to edge card

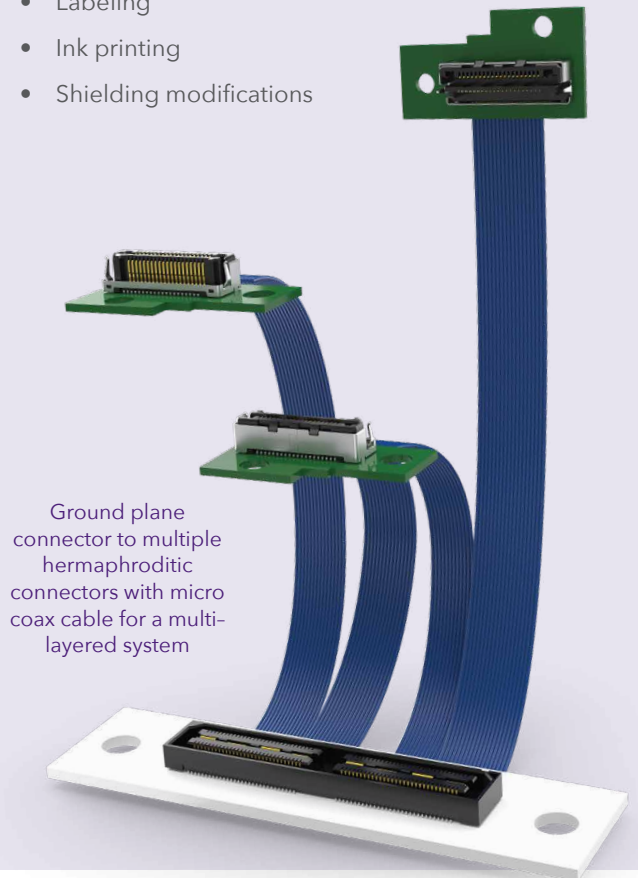

Ground plane connector to multiple hermaphroditic connectors with micro coax cable for a multi-layered system

EYE SPEED® CABLE TECHNOLOGY



ULTRA LOW SKEW TWINAX CABLE

Samtec's proprietary Eye Speed® co-extruded twinax cable technology eliminates the performance limitations and inconsistencies of individually extruded dielectric twinax cabling, improving signal integrity, bandwidth and reach for high-performance system architectures.

- Tight coupling between signal conductors
- Improved bandwidth (28-112+ Gbps) and reach
- Improved signal integrity and eye pattern opening
- Low skew (< 3.5 ps/meter) over extended lengths
- Supports Samtec Flyover® technology

Micro Cellular Dielectric Extrusion

- Critical dimensions measured at every dielectric spool
- Inline laser and CAPAC devices for capacitance monitoring and diameter control
- In-process stats summary sheet for Cpk acceptance



Eye Speed® Ultra Low Skew Twinax			28 AWG	30 AWG	32 AWG	34 AWG	36 AWG
Nominal Performance Specifications							
14 GHz (28G NRZ/ 56G PAM4)	0.25 m	IL (dB)	-1.0	-1.2	-1.5	-1.8	-2.2
	1.00 m		-3.9	-4.7	-5.9	-7.2	-8.7
28 GHz (56G NRZ/ 112G PAM4)	0.25 m		-1.5	-1.8	-2.2	-2.6	-3.2
	1.00 m		-6.0	-7.0	-8.7	-10.6	-12.7
Density/Flexibility			Good	Good	Better	Best	Best

* Eye Speed® Ultra Low Skew Twinax Cable is available in engineered impedance configurations of 85 Ω, 92 Ω and 100 Ω.

THINAX™ ULTRA PERFORMANCE TWINAX CABLE

- 40% smaller cross-sectional area
- 112 Gbps PAM4 performance
- Taped jacket miniaturizes the cable to match smaller, more dense connectors
- Allows for a smaller pitch within a row
- Achieving a smaller row-to-row pitch is dependent upon stack-up and BOR; customizable per application needs

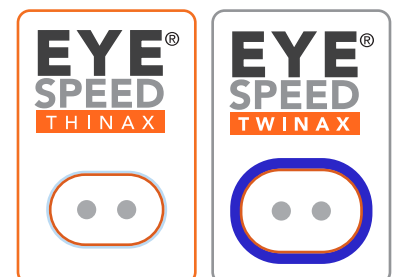

DIRECT ATTACH CABLE

- High-density contacts directly soldered to the Eye Speed® ultra low skew twinax cable
- Improved signal integrity by eliminating the transition board and its variability
- Achieves tighter tolerances



MICRO COAX CABLE

- Foaming introduces air voids for signal to travel faster
- Solid extrusion of foamed dielectric provides a constant and more durable construction
- Lighter weight and smaller size with higher bandwidth capabilities at longer lengths
- 26 - 38 AWG cable available
- Choice of signal conductor, shield and FEP dielectric to meet performance and cost specifications

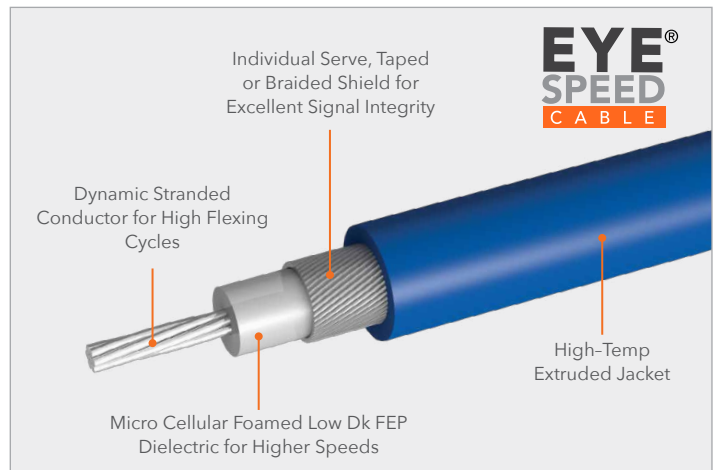

DYNAMIC TESTING

Samtec Eye Speed® Ultra Low Skew Twinax cable underwent Dynamic Insertion and Return Loss testing, proving the cable to be rugged with stable electrical performance after 250 flex/bend cycles.

This arduous flex and bend test determined that the performance of Samtec Eye Speed® ultra low skew twinax is essentially indistinguishable from the original raw, unbent cable.

Ultra low skew twinax provides the lowest insertion loss in the industry, controlled performance across temperature, and robust insertion loss in any assembly and operation environment. Contact HDR@samtec.com for higher cycle results.

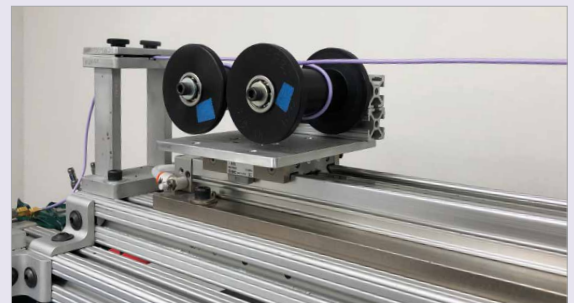

Six feet of ultra low skew twinax cable on mandrels was coiled/uncoiled moving back and forth on a slide at a rate of 20-25 cycles per minute.

CABLE MANAGEMENT

- Samtec works with system architects in the early stages to optimize the architecture for cable management while keeping signal integrity and thermals in mind
- Complimentary service using mockups with accurate cable lengths
- Minimize number of SKUs within one system
- Minimize pressure drop



ADVANCED OPTICAL SYSTEMS



FIREFLY™ MICRO FLYOVER SYSTEM™ samtec.com/firefly

- Designed for flexibility, optical (ECUO) for greater distances and copper (ECUE; page 17) for cost optimization
- Industry leading miniature footprint allows for higher density close to the data source
- x4 and x12 configurations
- PCIe®-Over-Fiber supports 3.0/4.0 data rates for low latency, power savings and guaranteed transmission
- -40 °C to +85 °C extended temperature system (ETUO) for military, aerospace and industrial applications
- Extreme Environment FireFly™ sealed and Parylene-Coated for exposed applications (ETMO)
- Supports data center, HPC and FPGA protocols, including Ethernet, InfiniBand™, Fibre Channel, Aurora and PCIe®
- Multiple end options available: MTP®, MXC®, MT, Glenair® Series 79, VITA 66.X and other common interfaces
- Development Kit available, see page 27 or visit samtec.com/kits

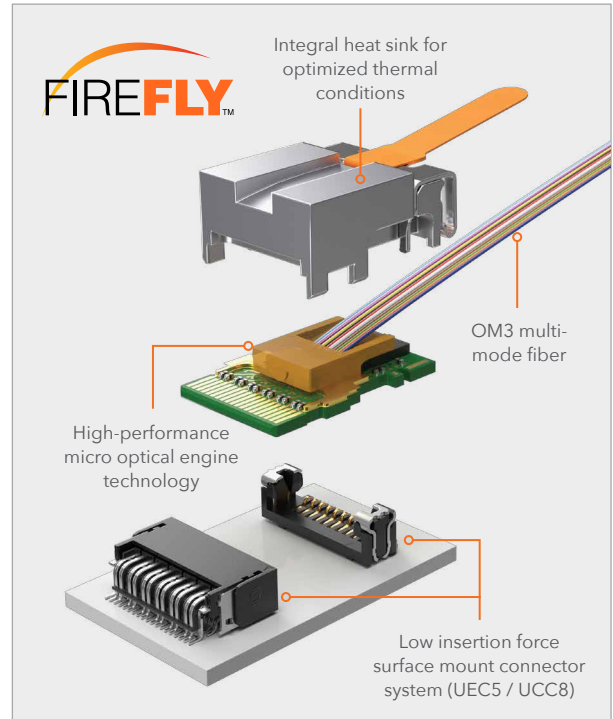

PCIe®-Over-Fiber Adaptor Card (PCOA), available in x4, x8 or x16 configurations; supports 3.0/4.0 platforms and transparent or non-transparent bridging

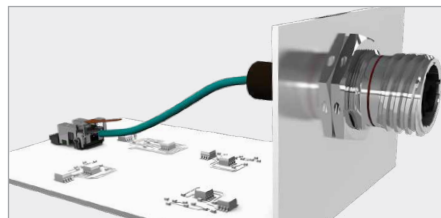

Extended Temp FireFly™ (ETUO) with Amphenol® Aerospace's bulkhead interconnects (MT38999) for rugged optical solutions



Glenair® Series 79 MT connector is an End 2 option featuring a miniature form factor and shielding; ideal for mil/aero and industrial applications

ECUO		PCUO		ETUO		PCOA	
FireFly™ Optical		PCIe®-Over-Fiber		Extended Temp FireFly™		PCIe®-Over-Fiber 3.0/4.0 Adaptor Card with FireFly™	
14 Gbps	x4 x12	8 Gbps	PCIe® 3.0 x4 PCIe® 3.0 x8 PCIe® 3.0 x16	10 Gbps	x4, x12		
16 Gbps	x12	16 Gbps	PCIe® 4.0 x4 PCIe® 4.0 x8 PCIe® 4.0 x16	25 Gbps	x4		
25 Gbps	x4 x12						
28 Gbps	x4						

MTP® and MXC® are registered trademarks of US Conec Ltd. Amphenol® is a registered trademark of Amphenol Corp.

FIREHAWK™ RUGGEDIZED OPTICAL TRANSCEIVERS

samtec.com/firehawk

- Chip Scale Package (CSP) with the industry's smallest footprint and lowest profile, weighing less than 0.4 grams
- FireHawk™ for Mil/Aero with an integrated microcontroller to automate key functions (CSPO)
- FireHawk™ for Space designed to withstand the impacts of radiation without the need for a microcontroller (CSSO)
- Extreme performance with up to 40 Gbps transfer rate
- 10G x 4 data rate (10 Mbps to 10 Gbps per channel)
- Rugged BGA board attach withstands high shock and vibration
- -40 °C to +85 °C extreme temperature range (+95 °C available)
- RVCON® optical cables are removable and replaceable for repair or reconfiguration
- Development Kit available, see page 27 or visit samtec.com/kits
- Roadmap: 25G x 4 system (up to 25 Gbps per channel) in the same 10G connector footprint

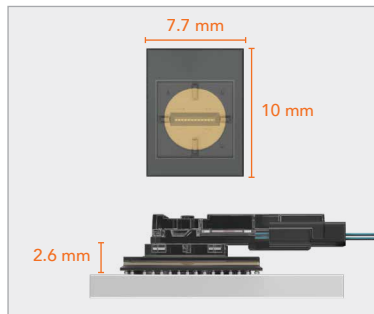

Ultra-compact, SWaP-optimized (Size, Weight and Power)

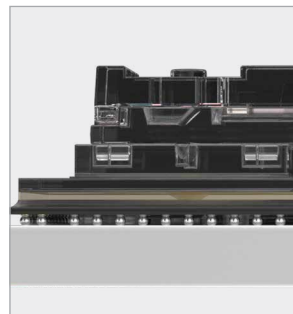

SMT reflow solderable with standard pick-and-place pad

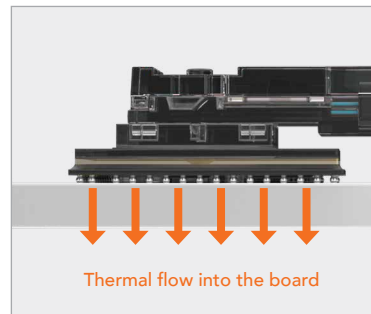

Direct mount to the PCB provides shortest possible thermal path

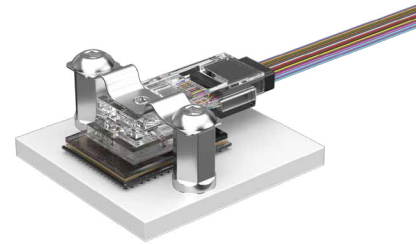

HALO™ NEXT GEN OPTICAL

- Capable of up to 112 Gbps PAM4 per lane
- Up to 16 channels (8 channel bidirectional)
- Low 6 mm profile with a 2-piece contact system
- Designed to withstand high shock and vibration
- Features a low center of gravity for a stable connection to the board
- Optically pluggable for easy replacement and increased uptime

PAM4
112
Gbps

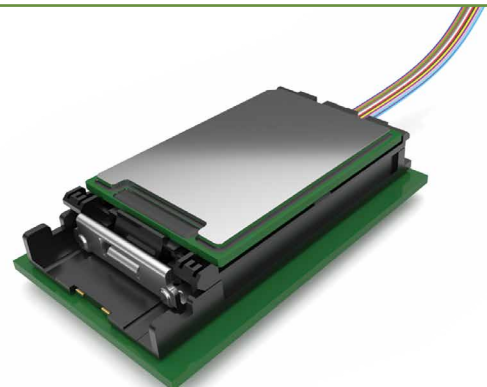

HIGH-PERFORMANCE RF SOLUTIONS



BULLS EYE® HIGH-PERFORMANCE TEST TO 90 GHz

- High-density, space-saving design that enables smaller evaluation boards and shorter trace lengths in test and measurement applications to 90 GHz
- Compression mounts to the board for placement directly adjacent to the SerDes being characterized
- Solderless design improves cost and is easy to use within a lab setting
- End 2 connection to instrumentation: 1.00 mm, 1.85 mm, 2.40 mm or 2.92 mm
- Single or double row
- Complete list of applications: SerDes characterization, clock/data recovery (CDR), mmWave radar, automated test equipment, FR2 5G networks
- Evaluation Kits available, see page 27 or visit [samtec.com/kits](https://www.samtec.com/kits)



BULLSEYE®
TEST POINT SYSTEM

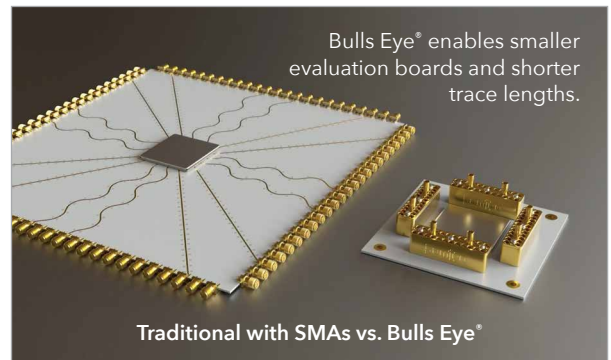

Frequency		90 GHz	70 GHz	50 GHz
Samtec Series		BE90A	BE70A	BE40A
Connection to Instrumentation		1.00 mm	1.85 mm	2.40 mm (50 GHz) 2.92 mm (40 GHz)
Block Options	No. of Rows	Single or Double		Double Row
	No. of Positions	1x: 2, 4, 8, 12 2x: 4, 8, 12, 16	1x: 2, 4, 8, 12 2x: 3, 4, 6, 8, 10, 12, 14, 16	2x: 3, 4, 6, 8, 10, 12, 14, 16

Test Assembly	BE90A	BE70A	BE40A
SerDes Characterization	PAM4 224 Gbps	PAM4 112 Gbps	PAM4 56 Gbps

HIGH-SPEED TEST CABLES

- Breakout test cables with RF connectors
- Capable of supporting PCIe® 4.0 and 5.0 (PCRF-G4/-G5)
- Capable of supporting 56 Gbps PAM4 (GC6-RF)

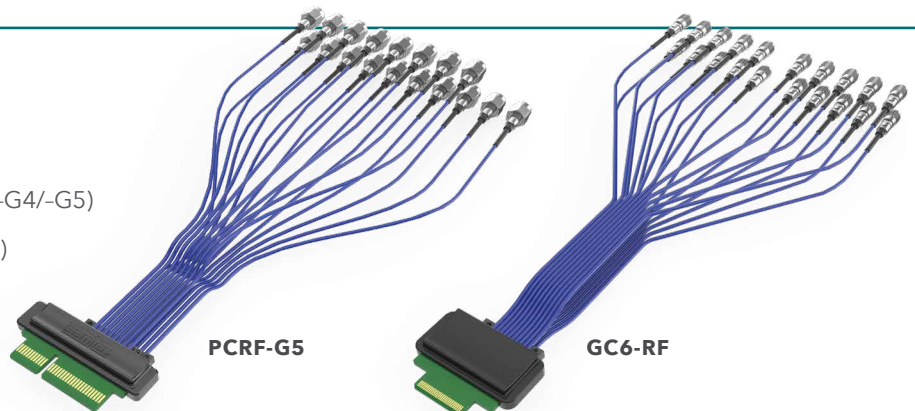

PRECISION RF CABLE ASSEMBLIES & CONNECTORS

- High-frequency, microwave/millimeter wave solutions to 110 GHz
- Cable assemblies, cable connectors & board level connectors
- Variety of interfaces: 1.00 mm, 1.35 mm, 1.85 mm, 2.40 mm, 2.92 mm, 3.50 mm, SSMA, SMP, SMPM, ganged SMPM, SMA, N Type, TNCA
- Magnum RF™ ganged SMPM for 40% greater density, less processing time and better positional alignment
- Low-loss microwave and millimeter wave cable from .047" to .277"
- Vertical or edge launch solderless compression mount board connectors for test and measurement applications
- Soldered push-on board connectors for high-density, blind-mate applications
- Between-series and in-series adaptors designed for well-performing VSWR



NEXT GEN RF CABLE ASSEMBLIES

- Phase and insertion loss stable microwave/millimeter wave cables - **Orange is the New Cable!**
- Optimized coaxial structure to meet increased demands placed on the Aerospace, Defense, Datacom, Computer/Semi and Instrumentation markets
- Cable construction designed to support extended frequency ranges for emerging applications
- Next gen cable provides improved IL performance vs. industry standard cable at the extended frequency range
- Interface options include 1.00 mm, 1.35 mm, 1.85 mm, 2.40 mm, 2.92 mm, SMPM, SMP, SMA, N Type and TNCA

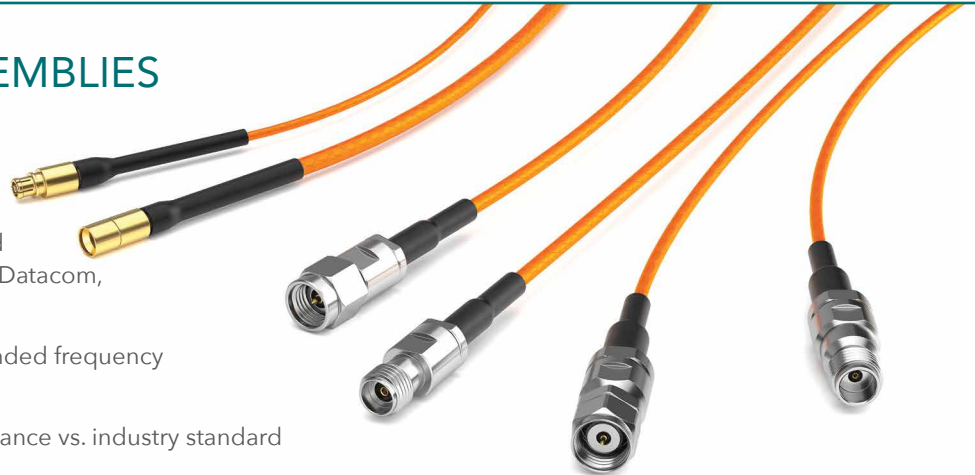

FLEXIBLE WAVEGUIDE

- Innovative technology that is flexible, easier to use and lower cost, while also maintaining low insertion loss, versus traditional metallic rigid waveguides
- E-Band frequency range of 60 to 90 GHz in development
- Flexible cable construction with dynamic stability
- Less signal loss than standard microwave coax cable
- Ultra-small form factor with threaded coupling and stripline routing

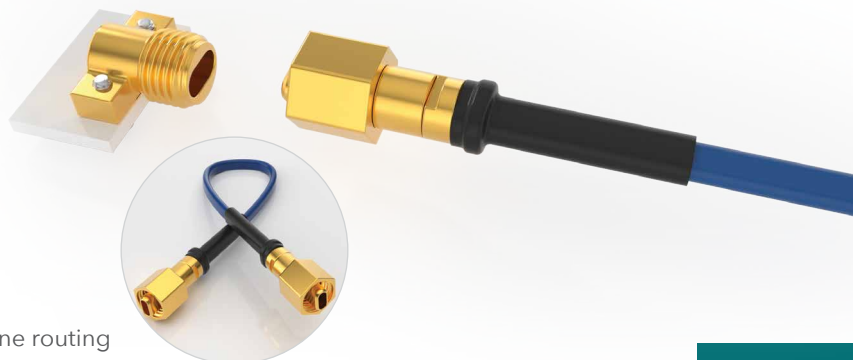

CABLE TECHNOLOGY & MANUFACTURING EXPERTISE

Samtec's state-of-the-art High-Speed Cable Plants provide industry-leading R&D and manufacturing of precision extruded micro coax and twinax cable, and next generation RF cable technology. Our priority is the development of differentiated products and technologies that address the existing and future challenges of bandwidth, reach, signal integrity, and phase stability demands.

MANUFACTURING TECHNOLOGY

- World-class in-house expertise
- Internally developed proprietary processes
- Extensive customization capabilities
- Procurement and test of new materials
- Quick-turn design and manufacturing
- Unparalleled pricing and delivery

NEXT GENERATION INNOVATION

- Real-time closed-loop control to adjust parameters
- Microcellular dielectric extrusion
- Co-extruded, low loss twinax cable
- Extreme density twinax cable
- Phase and insertion loss stable high frequency RF cable
- Halogen-free materials
- Thermal capabilities

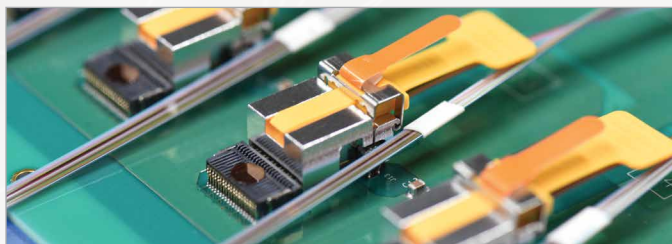
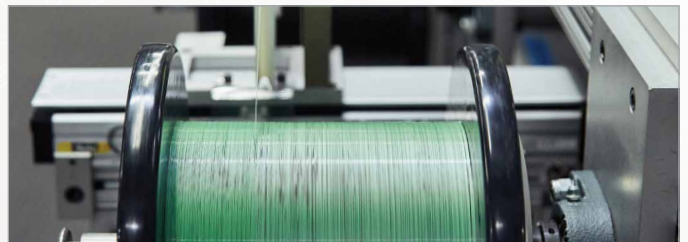
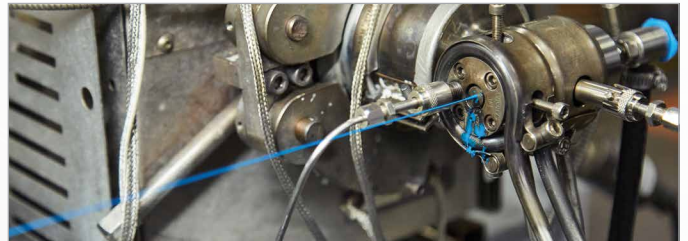

EVALUATION & DEVELOPMENT KITS

Samtec Evaluation and Development Kits provide system designers and engineers easy-to-use platforms for testing many of Samtec's popular products, helping to simplify the design process and reduce time to market.

Each kit includes the evaluation platform, calibration board(s), technical documentation and test reports. Additionally, each kit is tested and verified by Samtec's signal integrity experts before customer delivery. Visit samtec.com/kits or contact kitsandboards@samtec.com for current availability.

SIGNAL INTEGRITY EVALUATION KITS



**AcceleRate® Flyover®
Slim Cable System**
(ARC6/ARF6)



**NovaRay® Flyover®
Cable System**
(NVAC/NVAM-C)

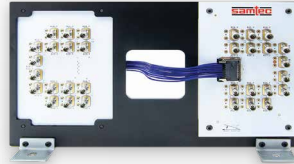

**Si-Fly™ Low Profile
Cable System**
(CPC/CPI)



**Flyover® QSFP
Cable System**
(FQSFP to ARC6)



**Flyover® QSFP
Double Density Cable System**
(FQSFP-DD to NVAC/ARC6)

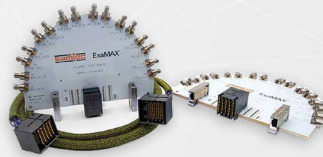

**ExaMAX® Backplane
Cable System**
(EBCM/EBTF-RA)

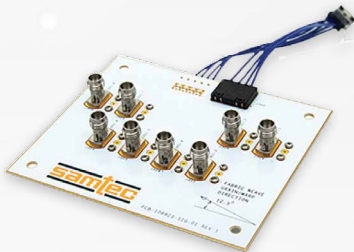

**FireFly™ Copper
Micro Flyover System™**
(ECUE/UEC5-2/UCC8)

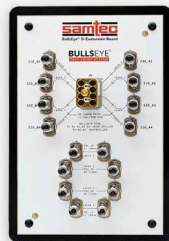

**Bulls Eye® 50 GHz
High-Performance Test System**
(BE40A)



**Bulls Eye® 70 GHz
High-Performance Test System**
(BE70A)

OPTICS KITS



25/28 Gbps FireFly™ FMC+ Kit

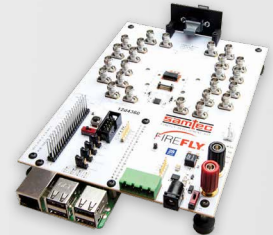

28 Gbps FireFly™ Kit

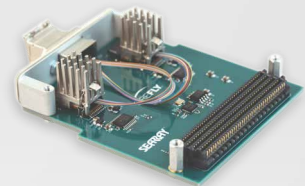

14 Gbps FireFly™ FMC Kit

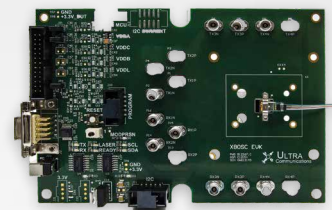

10 Gbps FireHawk™ Kit

SAMTEC SUDDEN SERVICE®



UNMATCHED LEADTIMES | Deliveries in Days, Not Weeks

Optimized logistics and innovative programs, along with Samtec's unique infrastructure and flexibility, help expedite the ordering process and get parts delivered in the fastest most efficient way possible.

Reserve™

This designation allows customers to quickly and easily identify availability of over 200,000 of Samtec's most popular connectors and cables - guaranteed to ship in 1-day.

Look for the **Reserve** badge throughout samtec.com to quickly determine if your part number is eligible, along with current availability, quantity breaks and pricing. Hundreds of part numbers are being added daily!

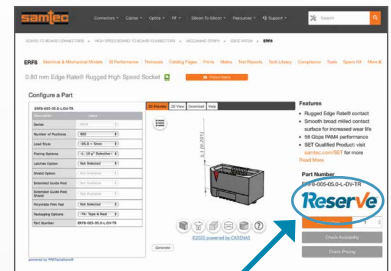

Free product samples, shipped in 24-hours or less have been a cornerstone of Samtec Sudden Service® since the company was founded. Visit samtec.com to quickly request your sample.



An innovative shipping program that bridges the gap between manufacturing facilities and customers, allowing for manufacturing flexibility without increased costs, and with even faster lead-times. Contact eCustomerService@samtec.com to learn more.

24/7 WORLDWIDE ACCESS | The Industry's Service & Technology Leader

Technical Support

Signal Integrity Group: sig@samtec.com

Application Support Group: asg@samtec.com

Interconnect Processing Group: ipg@samtec.com

Supply Chain Support

MySamtec™ Real-Time Account Access: account.samtec.com

Personal Account Managers/CSRs: eCustomerService@samtec.com

Upfront, Aggressive 24-Hour Quotes: ePricing@samtec.com

mySamtec™ | A Personalized Web Experience for Easy Ordering

Samtec's user-friendly eCommerce platform allows you to quickly and easily check product availability and pricing, as well as place and manage your orders online. Visit account.samtec.com to access your account.

ONLINE TOOLS | Find, Design & Validate Your Solution

Quickly and easily find the right solution, whether you prefer to search by product name or characteristics, browse through pictures, or build an assembly by entering physical specifications.

Picture Search

Browse through a highlight reel of Samtec's most popular products to find the ideal solution for your application, view specifications, check availability, order samples and more.

Picture Search tool interface showing various high-speed cable assemblies and a QR code. Below the image is a purple button with the URL: samtec.com/picturesearch/high-speed-cable

Downloadable Resources

Samtec offers immediate and unlimited access to all the resources needed to select the right solution – from 3D models, prints and footprints, to test reports, white papers and much more. Visit samtec.com to start exploring.

Collage of downloadable resources including 3D models, technical drawings, and test reports.

Solutionator®

Quickly build mated connector sets or design full cable assemblies using a wide variety of user-defined search parameters and filters, view specs and order samples in Samtec's online design tools.

Solutionator HS CABLE

Solutionator HS Cable tool interface showing a form for specifying cable assembly parameters and a 3D model of a cable assembly.

samtec.com/cablebuilder

Solutionator HS BOARD TO BOARD

Solutionator HS Board to Board tool interface showing a selection screen for connector types and orientation options.

samtec.com/hsb2b-solutionator

Solutionator RF CABLE

Solutionator RF Cable tool interface showing a form for specifying RF cable parameters and a 3D model of an RF cable assembly.

samtec.com/rf-cablebuilder

Solutionator FLEX STACKING

Solutionator Flex Stacking tool interface showing a selection screen for connector types and board termination options.

samtec.com/flex-solutionator

Solutionator ACTIVE OPTICS

Solutionator Active Optics tool interface showing a selection screen for connector types and board termination options.

samtec.com/optics-solutionator

INTEGRATION LEADS TO INNOVATION

Samtec's integrated business model facilitates high-level design and development of advanced interconnect systems and **TECHNOLOGIES**. Along with industry-leading expertise, this allows us to offer effective strategies and support for **optimizing the entire signal channel of high-performance systems**.

Samtec is structured like no other company in the interconnect industry. We work in a fully integrated capacity that enables true collaboration and results in uniquely innovative **PRODUCTS** because **our technology teams are not limited by the boundaries of traditional business units**.

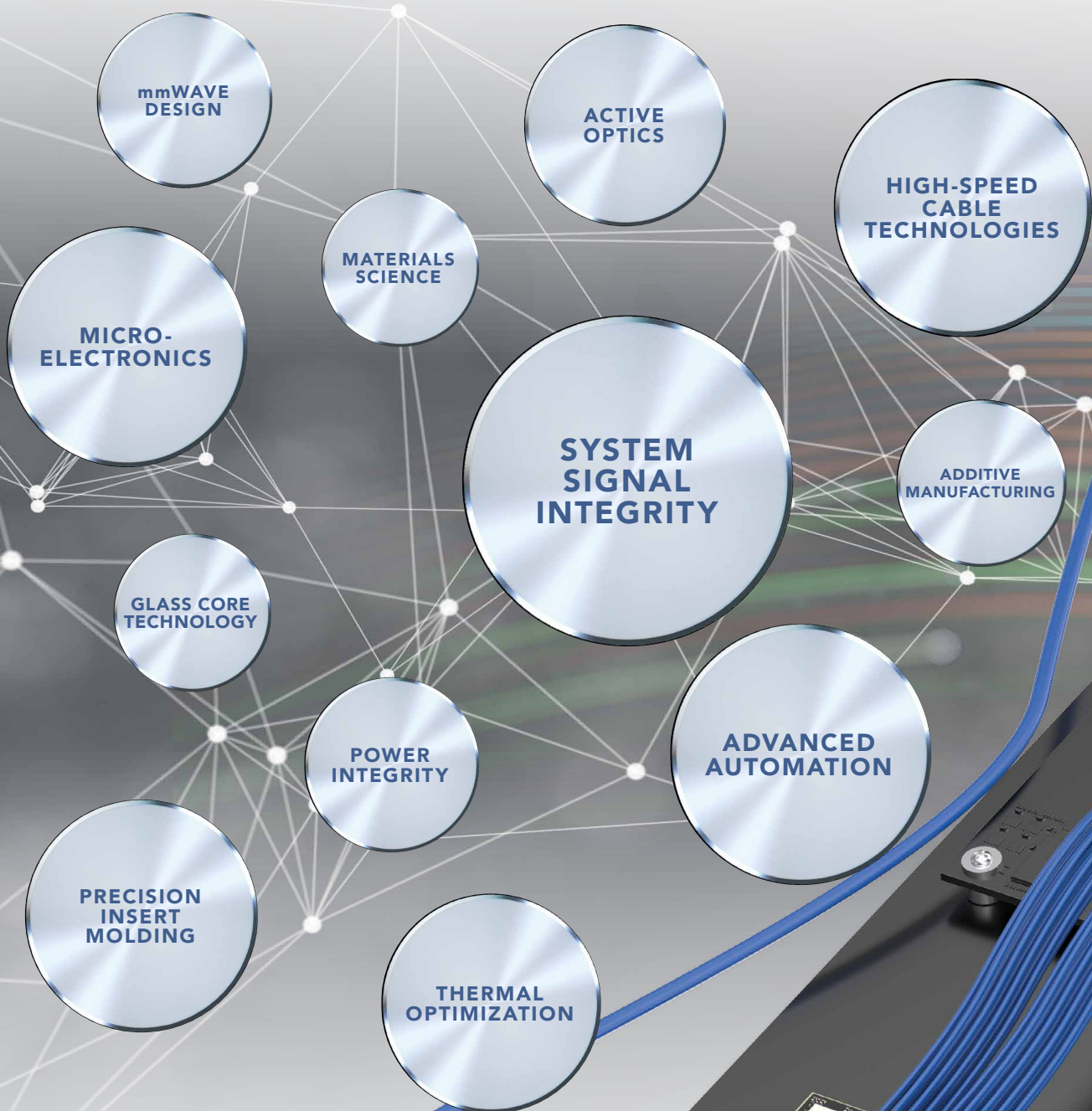

SILICON-TO-SILICON™ SOLUTIONS

As bandwidth, scale and power requirements continue to challenge conventional engineering methods, Samtec strives to help **optimize the landscape of your entire system** - and develop solutions, together.

Samtec's industry-leading signal integrity expertise, full system optimization strategies, and innovative products and technologies help address the challenges of next gen data transmission for **a path to 224 Gbps and beyond**.

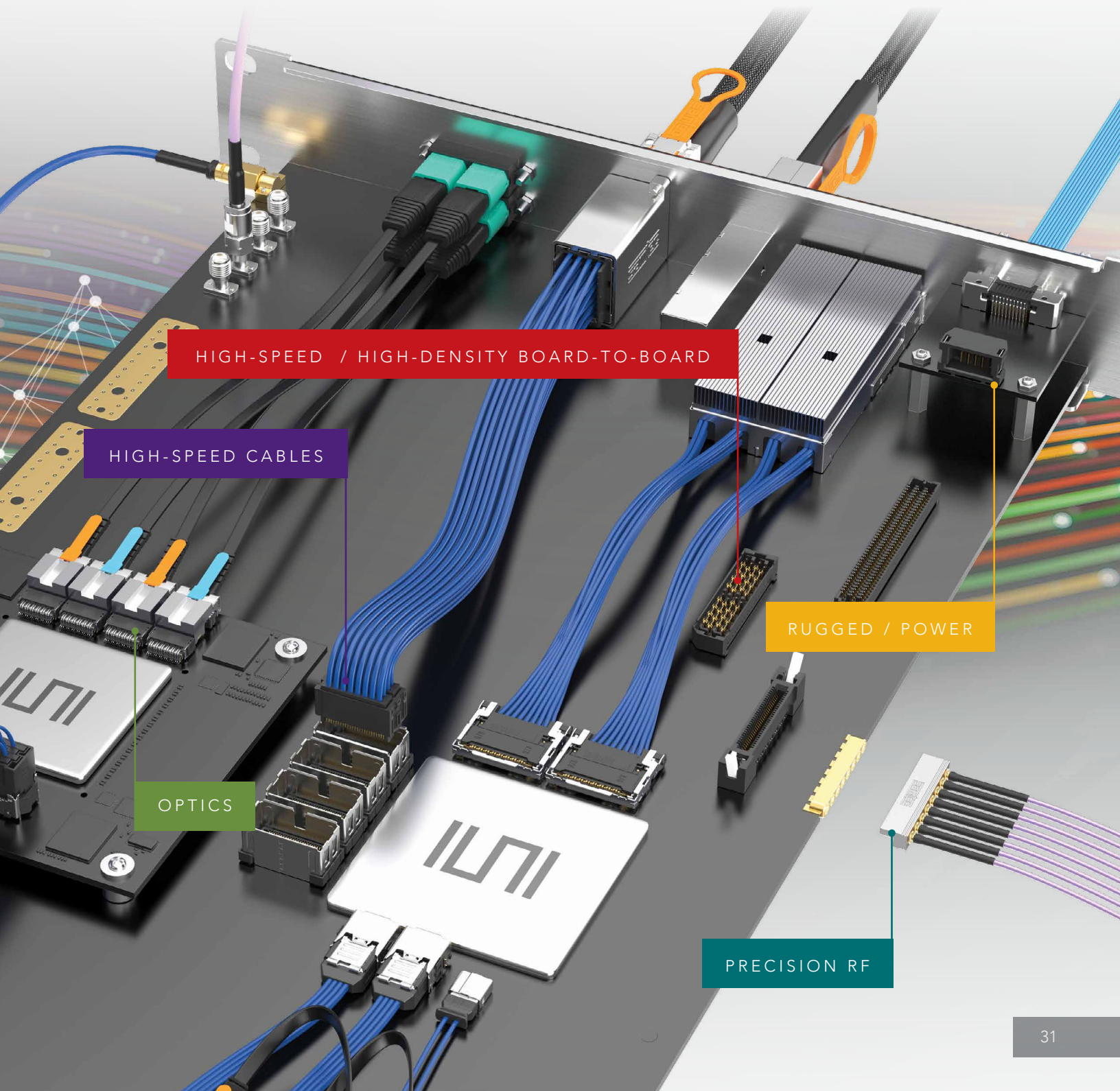

HIGH-SPEED / HIGH-DENSITY BOARD-TO-BOARD

HIGH-SPEED CABLES

OPTICS

RUGGED / POWER

PRECISION RF

GLOBAL SUPPORT NETWORK



samtec
SUDDEN SERVICE®

www.samtec.com

ISO-9001 and/or IATF 16949 Certified
© JUNE 2023, SAMTEC INC.