

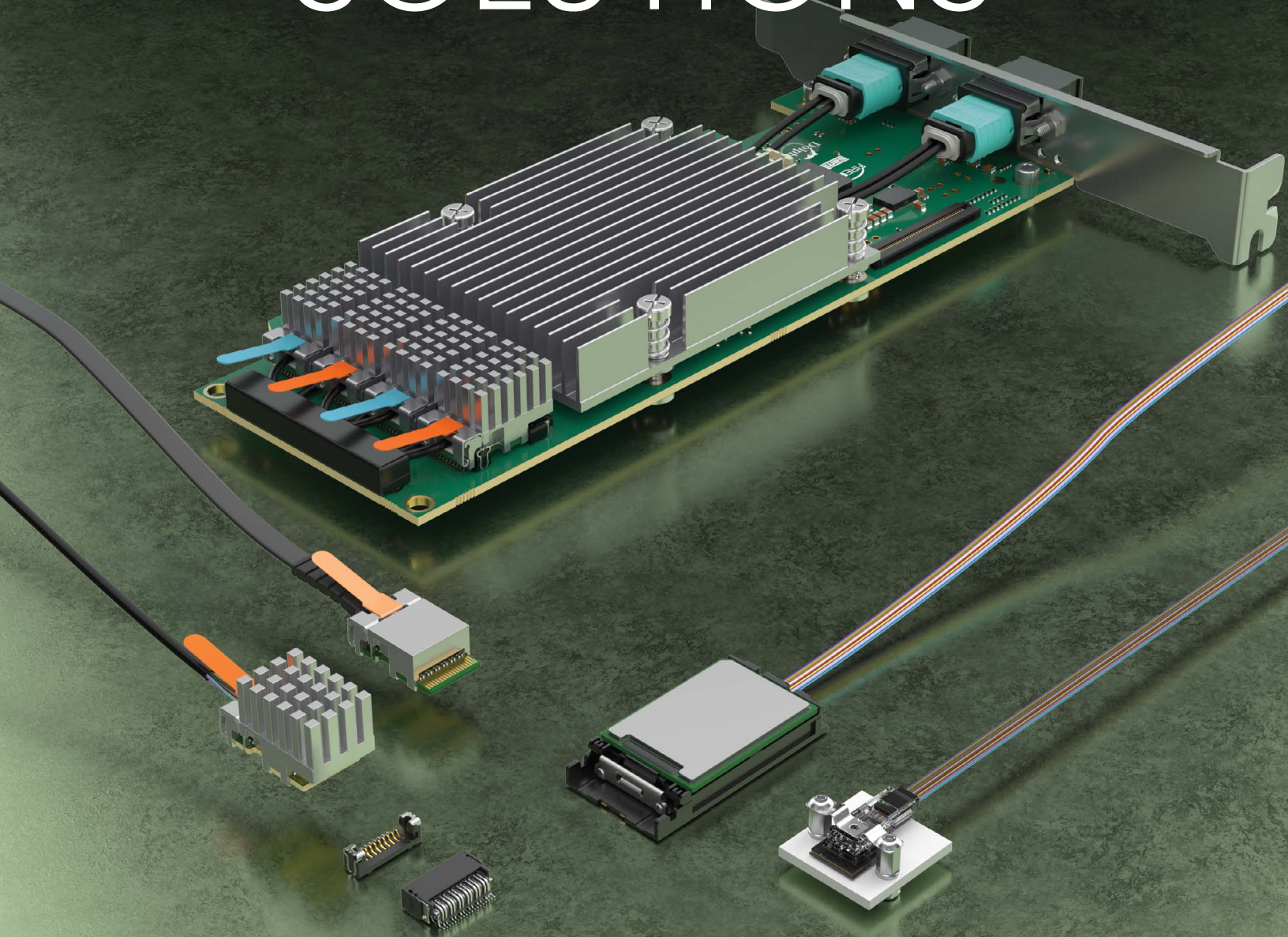

# OPTICAL SOLUTIONS





# ADVANCED OPTICAL SYSTEMS

## FIREFLY™ MICRO FLYOVER SYSTEM™

[samtec.com/firefly](http://samtec.com/firefly)

- Designed for flexibility, optical (ECUO) for greater distances and copper (ECUE) for cost optimization
- Industry leading miniature footprint allows for higher density close to the data source
- x4 and x12 configurations
- PCIe®-Over-Fiber supports 3.0/4.0 data rates for low latency, power savings and guaranteed transmission
- -40 °C to +85 °C extended temperature system (ETUO) for military, aerospace and industrial applications
- Extreme Environment FireFly™ sealed and parylene-coated for exposed applications (ETMO)
- Supports data center, HPC and FPGA protocols, including Ethernet, InfiniBand™, Fibre Channel, Aurora and PCIe®
- Multiple end options available: MTP®, MXC®, MT, Glenair® Series 79, VITA 66.X and other common interfaces
- Development Kit available, visit [samtec.com/kits](http://samtec.com/kits)

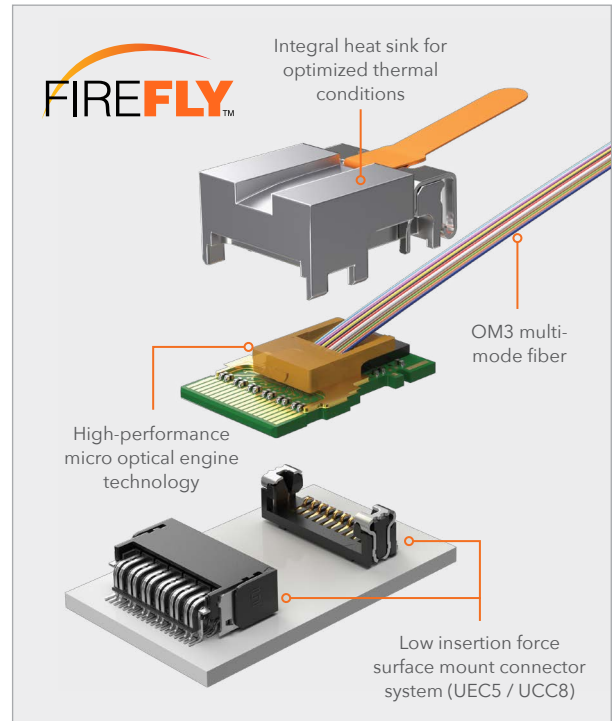

PCIe®-Over-Fiber Adaptor Card (PCOA), available in x4, x8 or x16 configurations; supports 3.0/4.0 platforms and transparent or non-transparent bridging

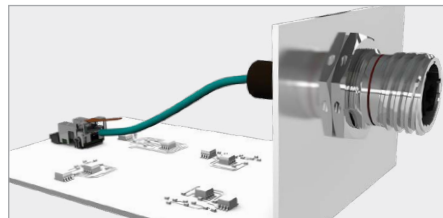

Extended Temp FireFly™ (ETUO) with Amphenol® Aerospace's bulkhead interconnects (MT38999) for rugged optical solutions



Glenair® Series 79 MT connector is an End 2 option featuring a miniature form factor and shielding; ideal for mil/aero and industrial applications

ECUO			
FireFly™ Optical			
14 Gbps	x4	25 Gbps	x4
	x12		x12
16 Gbps	x12	28 Gbps	x4

PCUO/PTUO	
PCIe®-Over-Fiber & Extended Temp PCIe®-Over-Fiber	
8 Gbps	PCIe® 3.0 x4 PCIe® 3.0 x8 PCIe® 3.0 x16
(PCUO & PTUO)	
16 Gbps	PCIe® 4.0 x4 PCIe® 4.0 x8 PCIe® 4.0 x16
(PCUO)	

ETUO/ETMO	
Extended Temp FireFly™ & Extreme Environment FireFly™	
10 Gbps	x4, x12
(ETMO x4 only)	
25 Gbps	x4

MTP® and MXC® are registered trademarks of US Conec Ltd. Amphenol® is a registered trademark of Amphenol Corp.

## FIREHAWK<sup>™</sup> RUGGEDIZED OPTICAL TRANSCEIVERS

samtec.com/firehawk

- Chip Scale Package (CSP) with the industry's smallest footprint and lowest profile, weighing less than 0.4 grams
- FireHawk<sup>™</sup> for Mil/Aero with an integrated microcontroller to automate key functions (CSPO)
- FireHawk<sup>™</sup> for Space designed to withstand the impacts of radiation without the need for a microcontroller (CSSO)
- Extreme performance with up to 40 Gbps aggregate transfer rate
- 10G x 4 data rate (10 Mbps to 10 Gbps per channel)
- Rugged BGA board attach withstands high shock and vibration
- -40 °C to +85 °C extreme temperature range (+95 °C available)
- RVCON<sup>®</sup> optical cables are removable and replaceable for repair or reconfiguration
- Development Kit available, visit [samtec.com/kits](http://samtec.com/kits)
- Roadmap: 25G x 4 system (up to 25 Gbps per channel) in the same 10G connector footprint

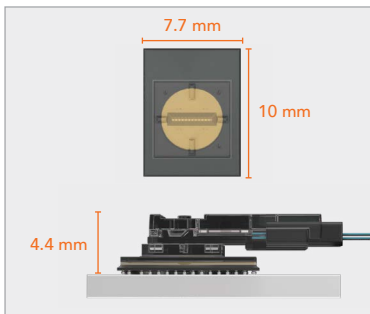

Ultra-compact, SWaP-optimized (Size, Weight and Power)

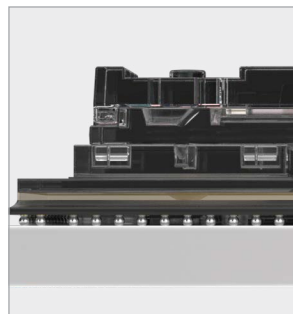

SMT reflow solderable with standard pick-and-place pad

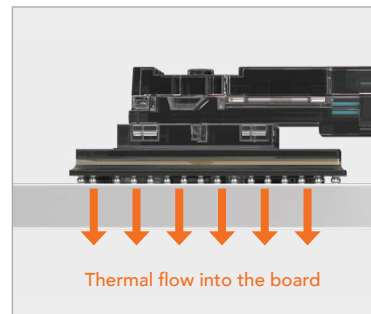

Direct mount to the PCB provides shortest possible thermal path

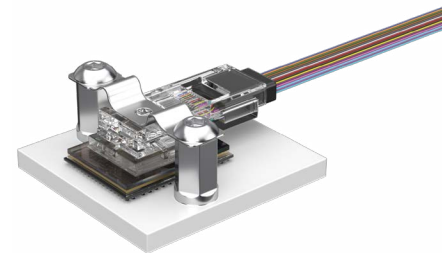

## HALO<sup>™</sup> NEXT GEN OPTICAL

- Capable of up to 112 Gbps PAM4 per lane
- Up to 16 channels (8 channel bidirectional)
- Low 6 mm profile with a 2-piece contact system
- Designed to withstand high shock and vibration
- Features a low center of gravity for a stable connection to the board
- Optically pluggable for easy replacement and increased uptime

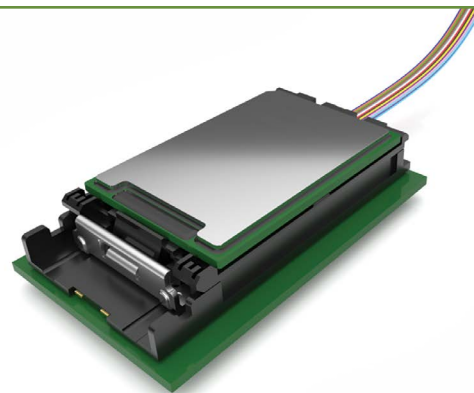

# OPTICS EVALUATION & DEVELOPMENT KITS



From concept and prototype to development and production, Samtec-designed and Partner-designed kits and boards featuring FireFly™ and FireHawk™ simplify design and reduce time to market. For more information, please visit [samtec.com/kits](http://samtec.com/kits) or contact [KitsAndBoards@samtec.com](mailto:KitsAndBoards@samtec.com).

## 28 Gbps FireFly™ Evaluation Kit

Samtec's 28 Gbps FireFly™ Evaluation Kit offers an easy-to-use platform for testing and real-time evaluation of the FireFly™ Micro Flyover System™. The kit supports copper or optical FireFly™ in x4 or x12 configurations. (Samtec P/N: REF-209623-01)

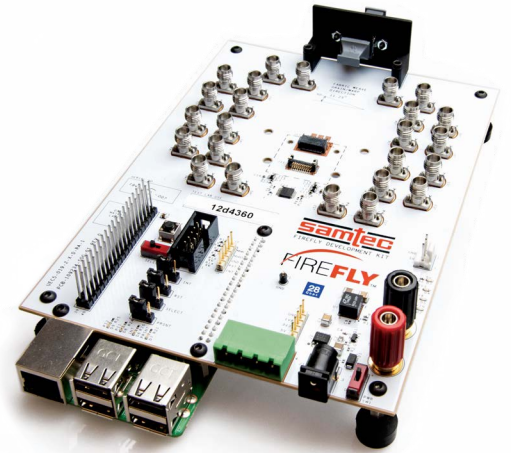

## 14 Gbps FireFly™ FMC Development Kit

Samtec's 14 Gbps FireFly™ FMC Development Kit is VITA 57.1 electrically compliant and provides up to 140 Gbps full-duplex bandwidth over 10 channels from an FPGA to an industry-standard multi-mode fiber optic cable. (Samtec P/N: REF-193429-01)

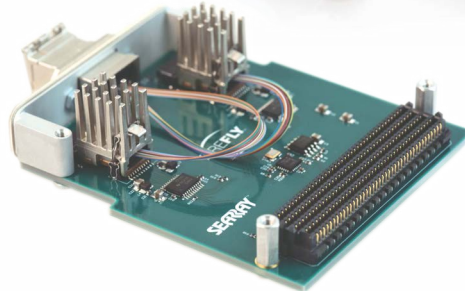

## 25/28 Gbps FireFly™ FMC+ Development Kit

Samtec's 25/28 Gbps FireFly™ FMC+ Module is VITA 57.4 electrically compliant and provides up to 400/448 Gbps full-duplex bandwidth over 16 channels from an FPGA to an industry-standard multi-mode fiber optic cable. (Samtec P/N: REF-200772-XXX-XX-01)

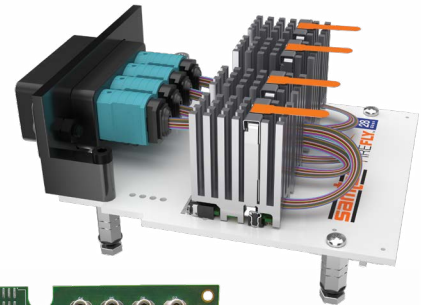

## 10 Gbps FireHawk™ Evaluation Kits

Samtec's FireHawk™ Evaluation Kits offer real-time evaluation of FireHawk™ rugged optical transceivers in a lab or benchtop setting. Rated to 10 Gbps per lane in a x4 configuration, the transceivers combine extreme density with extreme performance to meet the harshest environments.

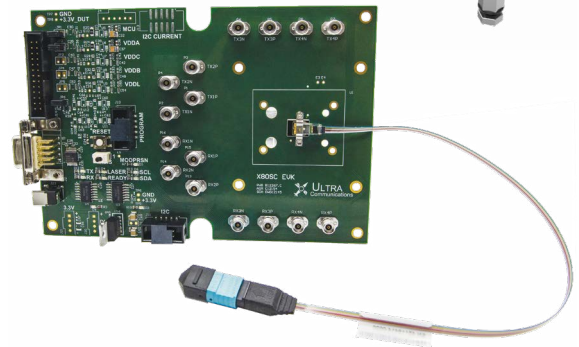

KIT NAME	SAMTEC KIT PN	ULTRA COMMUNICATIONS KIT PN	APPLICATIONS
FireHawk™ CSSO 10 Gbps Evaluation Kit	REF-230448-01	X80S-0103-EVK-003	Space
FireHawk™ CSPO 10 Gbps Evaluation Kit	REF-230449-01	X80SC-0102-EVK-003	Mil/Aero



**samtec**  
SUDDEN SERVICE®

UNITED STATES • NORTHERN CALIFORNIA • SOUTHERN CALIFORNIA • SOUTH AMERICA • UNITED KINGDOM  
GERMANY • FRANCE • ITALY • NORDIC/BALTIC • BENELUX • ISRAEL • INDIA • AUSTRALIA / NEW ZEALAND  
SINGAPORE • JAPAN • CHINA • TAIWAN • HONG KONG • KOREA

[samtec.com/optics](https://www.samtec.com/optics)