

Automotive Cable & PCB Connector System

FAKRA Connectors

AUTOMOTIVE





Rosenberger Automotive – a Synonym for Quality and Innovation

On the following pages we present the high-quality Rosenberger FAKRA connectors developed in our Automotive Business Area to fulfill the tough requirements of the automotive industry.



Rosenberger Global Network	04
Quality & Environment	06
Competencies & Technology	08
Research & Development	10
Rosenberger Automotive	12
FAKRA Product Overview	14
FAKRA SF	16
FAKRA Number Code	18
FAKRA Coding	19
FAKRA Cable Groups	20
FAKRA Plating Code	21
FAKRA Interface Dimensions	22
FAKRA Technical Data (Code 59)	23
FAKRA Connectors	24
Cable Connectors & Housings, Straight	24
Cable Connectors & Housings, Right Angle	30
Cable Connectors & Housings, Waterproof	32
PCB Connectors Wave Soldering	34
PCB Connectors SMD Pin-in-Paste	35
FAKRA Calibration Kit	38
Tools	40
Index	44

The Rosenberger online catalog contains the current Rosenberger standard FAKRA product range with specific details, including data sheets, assembly instructions, and panel piercings.

www.rosenberger.com/ok/fakra



Rosenberger Global Network

Rosenberger is one of the world's leading manufacturers of impedance controlled and optical connectivity solutions. It provides connectivity solutions in high-frequency, high-voltage, and fiber-optic technology for mobile communication networks, data centers, test & measurement applications, automotive electronics, as well as high-voltage contact systems, medical electronics or aerospace engineering.

A global network of R&D, manufacturing and assembly locations provides innovation, optimized cost structure and excellent customer services world-wide. More than 10,000 employees develop, produce and sell our products.

Contacts Automotive

Headquarters

Rosenberger

Rosenberger Hochfrequenztechnik GmbH & Co. KG
Hauptstraße 1 | 83413 Fridolfing
P.O. Box 1260 | 84526 Tittmoning
Germany
Phone +49 8684 18-0
info@rosenberger.com
www.rosenberger.com

Sales Automotive

Europe

Germany

Rosenberger Hochfrequenztechnik
GmbH & Co. KG
Hauptstraße 1
83413 Fridolfing
Germany
Phone +49-8684-18-1694
automotive@rosenberger.com

France

Rosenberger Automotive France
Actipark
17, Rue des Frères Lumière
67201 Eckbolsheim
France
Phone +33-3-90 20 76 03
Fax +33-3-90 20 76 01
automotive.france@rosenberger.com

Italy

Rosenberger Italia Srl
Via Torri Bianche 7 - Piano 7
20871 Vimercate (MI)
Italy
Phone +39-039-96 30306
info-italia@rosenberger.com

Spain

Rosenberger Telecom, S.A.
C/Lozoya nº2, nave 18 -
P.I. Ventorro del Cano
28925 Alcorcón - Madrid
Spain
Phone +34 91 352 8352
Fax +34 91 352 9813
rosenberger@rosenberger.es

Sweden

Rosenberger Sverige AB
Vallgatan 5B
17067 Solna
Sweden
Phone +46-8-6 36 26 00
Fax +46-8-6 36 26 26
info@rosenberger.se

United Kingdom

Rosenberger UK Ltd.
York House, Cottingley Business Park
Bradford, BD16 1PE
England
United Kingdom
Phone +44-7980 730423
automotive.uk@rosenberger.com

North America

USA

Rosenberger Automotive USA
15900 Michigan Ave, Suite 5
Dearborn, MI 48126
United States of America
Phone +1-734-673 4131
Phone +1-248-259 5750
automotive.usa@rosenberger.com





The Rosenberger headquarters, located in Fridolfing in the southeast part of Bavaria, Germany, is the global center for our activities.

South America

Brazil

Rosenberger Domex Telecom Ltda.
 Cabletech Avenue, 601
 Guimirim
 CEP 12295-230
 BR-Cacapava - São Paulo
 Brazil
 Phone +55-12-3221 8500
 Fax +55-12-3221 8543
vendas@rosenbergerdomex.com.br

Chile

Rosenberger Sudamérica Ltda.
 Aldunate 1961,
 Santiago 836-1195
 Chile
 Phone +56-2-3 67 11 70
 Fax +56-2-3 67 12 78
rosenberger@rosenberger.cl

Asia

China, Asia, Australia

Rosenberger
 Asia Pacific Electronic Co., Ltd.
 No. 3, Anxiang Road, Block B
 Tianzhu Airport Industrial Zone
 Beijing 101300
 PR China
 Phone +86-10-80 48 19 95
 Fax +86-10-80 48 24 38
info@rosenberger.com.cn

Japan

Rosenberger Automotive Japan, LLC.
 Sanno Mori Building 2-10-1 Nagata-Cho,
 Chiyoda-Ku
 100-0014 Tokyo
 Japan
 Phone +813 5511 2525
automotive.japan@rosenberger.com

Korea

Rosenberger Automotive Korea
 #307/104, Gwang-Gyo Eduhiem, 904-1,
 Iui-Dong, Yeong Tong-gu
 Suwon-si Gyeonggi-do (441-813)
 Korea
 Phone +82 70 7779 2236
 Mobile +82 10 4729 6194
automotive.korea@rosenberger.com

India

Rosenberger Electronic Co. (India) Pvt
 Limited
 Plot No. 263, Sector 6
 IMT Manesar, Gurgaon
 Haryana-122050
 India
 Phone +91-124-477 55 00
 Fax +91-124-477 55 01
info@rosenberger.in

Quality & Environment

The quality of our products, solutions and services is an essential part of our corporate strategy.

Ensuring the optimum quality of products and services and taking responsibility for our environment are fundamental elements of Rosenberger's corporate philosophy. Our quality philosophy does not just cover the optimization of parts and products, but also the continuous improvement of all company processes: from product development, planning, procurement, production, sales, logistics right through to environmental policy. To summarize, we want to offer maximum benefits for our customers all over the world.

We aim to act in an environmentally conscious manner, use materials economically, protect natural resources, recycle, and ensure energy efficiency.

As we have continuously improved our processes and consistently applied our quality management systems, we have been awarded many certificates.

Rosenberger has won a number of prestigious quality awards and prizes from several renowned customers and organizations for implementing its quality and environmental objectives.

IMDS System

Rosenberger is registered with the IMDS system (Internationales MaterialDatenSystem der Automobilindustrie) since 2001. The products are fed systematically into the IMDS system.

www.mdsystem.com



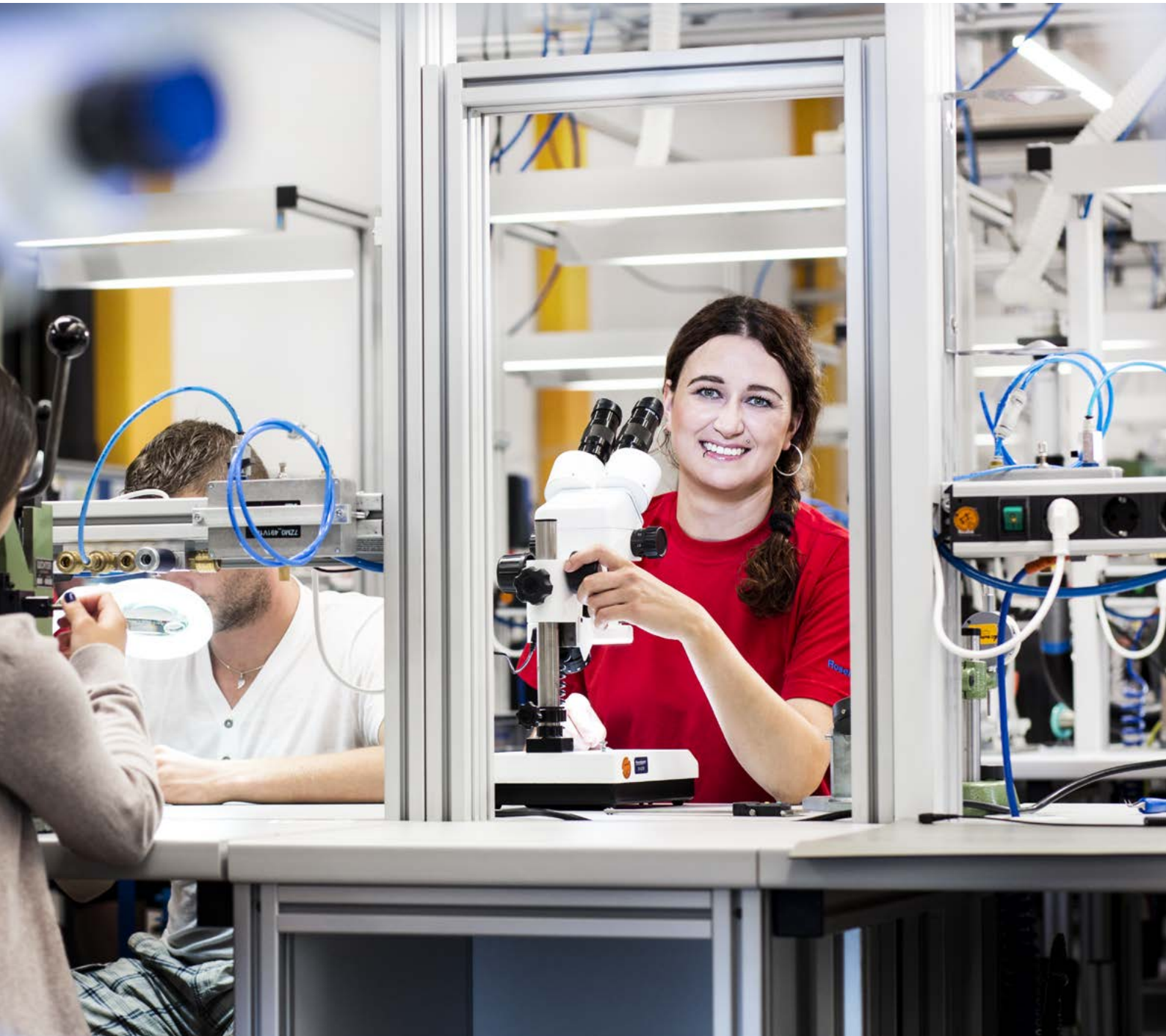

Certificates

- IATF 16949
- DIN EN 9100
- ISO 9001
- ISO 14001
- DaKKs accreditation according to DIN EN ISO 17025

Competencies & Technology

Rosenberger's mission is to be a leader when it comes to innovation and technology within its business segments.

The ongoing focus on cost management and process optimization complements our commitment to the increasingly stringent requirements for delivering products of the highest quality. Effective research & development, the very latest manufacturing technologies, the highest possible levels of efficiency in production processes, and continuous improvement of process automation make up Rosenberger's core competencies.





Research & Development

Science-based high frequency know-how enables us to continuously improve existing products and to design innovative products and solutions whether standard or customer specific. Numerous patents are proof of Rosenberger's leadership as a creative and innovative partner.

Production

By manufacturing everything in house and using state of-the-art manufacturing technologies, Rosenberger can continue to develop and optimize key manufacturing technologies – turned parts production, stamped & formed technology, injection molding technology. Manufacturing everything in house ensures a high degree of flexibility, and continuous quality controls, and means that newly designed products can be produced in the required quantities.

Plating Technology

Our components can be electroplated quickly and flexibly in our own in-house electroplating facilities, regardless of whether this is to provide corrosion protection, optimized conductivity, or other technical and physical characteristics. Environmental protection is another key factor which must be taken into account when coating surfaces.

Assembly

Rosenberger operates manufacturing and assembly locations around the world – fully automated assembly centers and customer-oriented cable assembly locations offer global support and local sourcing.

Injection Molding

We use the very latest machinery and methods, as well as special materials and components to ensure the precision and durability of our tools and products. Rosenberger is able to process all available high-performance plastics.

EMC and RF Design

The increasing amount of electrical systems in hybrid and/or self-driven-vehicles increases the probability that electrical currents will interact with one another. To reduce unwanted effects, such as a high bit error rate, good shielding is needed. In addition, in unshielded systems with differential transmission technology, EMC is even more important. Furthermore, even if your transmission line is unaffected by the environment, the loss of signal quality caused by reflections or cable attenuation has to be minimized.

To analyze the transmission behavior, FEM and circuit simulation tools are used. Different system parameters, such as characteristic impedance, transmission and reflection coefficient, crosstalk and screening attenuation can be determined and optimized by simulation.

As a result, high frequency signals with high signal-to-noise ratio and high transmission form the basis for implementing efficient modulation schemes for ever-increasing data rates.

Mechanical and Thermal Design

Due to strict safety standards for hybrid/electrical engines and autonomous driving, the mechanical and thermal requirements have increased considerably in recent years.

Mechanical FEM calculations are performed for high retention forces or high coding efficiency at the connector plastic housing. Investigations into the physics of an electrical contact (e.g., electrical resistance or fretting) enable us to design contact springs with optimized contact forces and an electrically stable contact resistance over their entire lifetime, taking into account all tolerances, for example.

Knowledge about the resistance of a contact is the key when it comes to simulating power loss and heating of the contact system. This makes it possible to achieve mechanical robustness, high efficiency, and minimal heating of the connector even quicker.



Research & Development

One of the basic requirements of automotive contact systems is to create a robust electrical and mechanical design in a very small installation space. When it comes to achieving this, simulation-based component development is the state of the art.

Specialists from different engineering sciences support all departments during the complete product lifetime. Finite element (FEM) calculations are used to get the products on the market quickly and keep the development costs down, especially for early concepts.

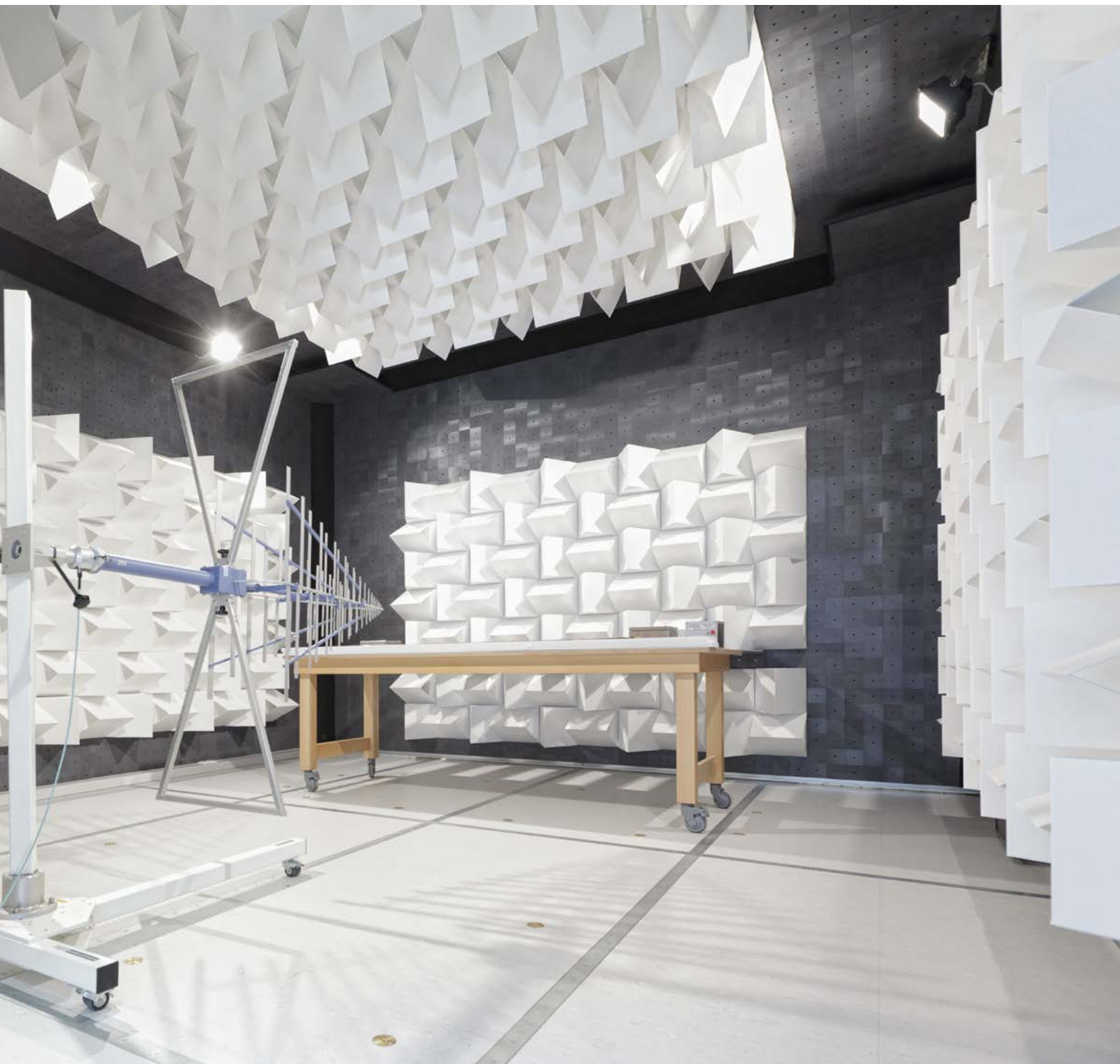

Rosenberger Automotive

At Rosenberger, we firmly believe in developing technology for the future. We are currently working on products and solutions that will shape our lives in the future.

We want to get faster and smarter in what we do and how we do it. Car driver assistance systems, connected car technology, electromobility, infotainment systems – Rosenberger is extremely committed to designing innovative connector systems for future automotive electronics.

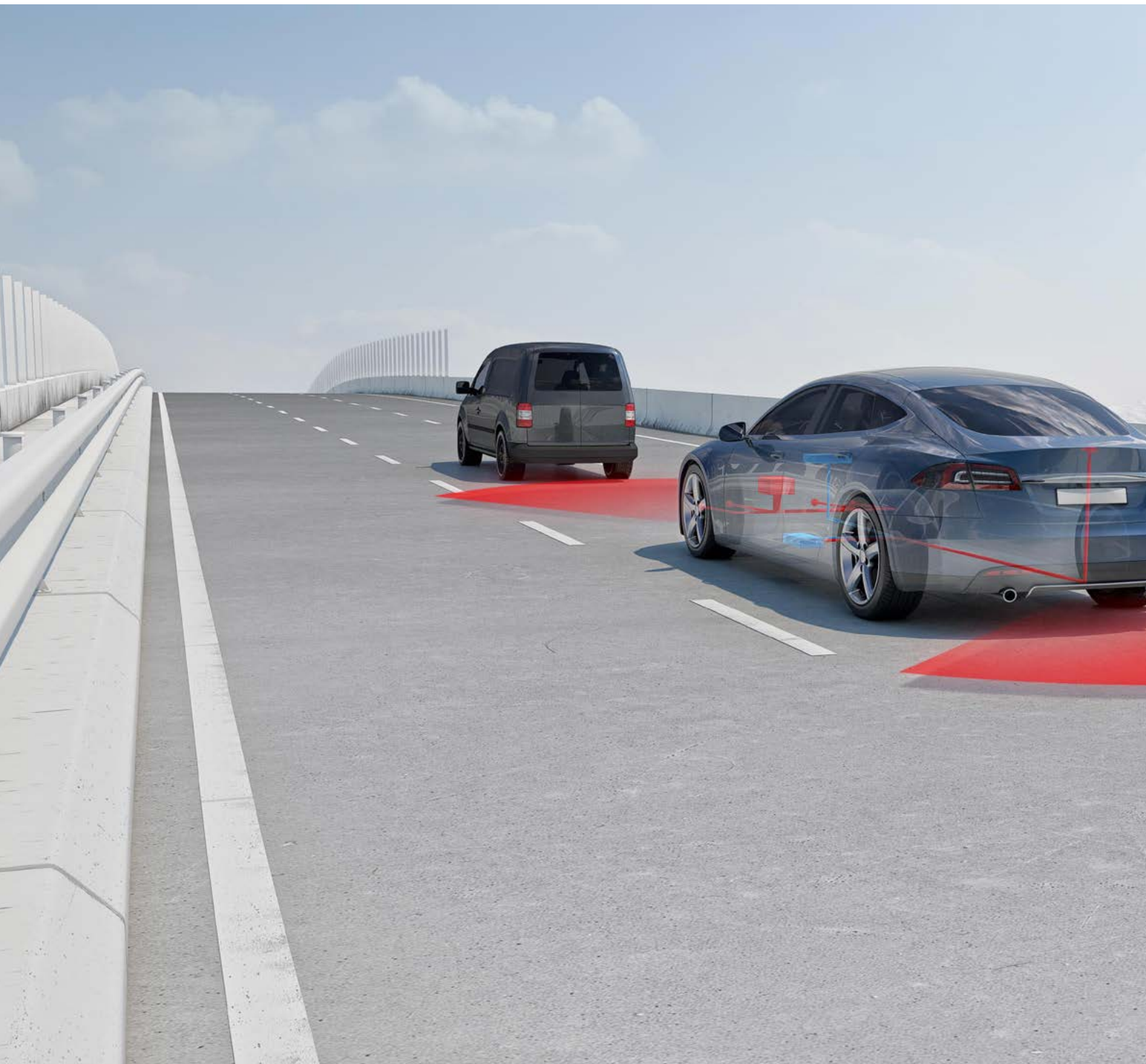



In 2000, Rosenberger started working in the automotive sector, designing and producing customized and standard products for these specific markets.

Rosenberger Automotive is a specialist development partner when it comes to integrating connector designs and customer-specific solutions with the highest quality and best performance – while continuing to meet customer price targets.

The contact systems have been specially designed to fulfill the tough requirements of the automotive industry. From the beginning, Rosenberger has developed a close and open relationship with its customers.

The priority in the most automotive applications, such as autonomous driving and driver assistance systems, is to ensure safety. It is necessary to determine exact positions, continuously calculate routes, and detect and classify objects. High data volumes from several cameras, various sensors, and navigation sources must be combined and transported for this purpose – in real time.

Application Areas

- Autonomous Driving
- Driver Assistance Systems
- Navigation
- Infotainment
- Fond-Entertainment
- Internet & Mobile Communication
- Next Generation WLAN: "WiGig" (Wireless Gigabit)

FAKRA Product Overview

Rosenberger FAKRA connectors have been specially designed to fulfill the tough requirements of the automotive industry. The sophisticated coding system of the standard plastic housing offers 13 mechanical and colored codings and one neutral coding.

In addition to turned-part production, the stamped and formed (SF) technology and die-cast production are being used increasingly. The precision-manufactured automotive products are ideally suited to reliable and fully automated assembly by harness makers, which ultimately leads to a significant reduction in costs.

Rosenberger FAKRA* products comply with the standard ISO 20860-1 & 2 and USCAR 17 & 18.

Product Range

- Cable connectors, straight and right angle
- FAKRA* SF** connectors
- 360° turnable right angle connectors
- PCB connectors SMD Pin-in-Paste and wave soldering types
- Panel connectors
- Connector types: single and multi-connectors, male and female types
- Waterproof connectors
- Calibration kit
- Tools

Product Features

- Standardized FAKRA cavity, compatible with stamped and formed connectors as well as turned connectors
- Temperature range from -40° C to +105° C
- Primary and secondary locking systems create high assembly security
- RoHS, WEEE, ELV Conformity

* FAKRA = FACHKREISAutomobil
(Automobile Expert Group)

** FAKRA SF = FAKRA Stamped and Formed





FAKRA SF

Stamped and Formed

FAKRA SF connectors (SF = Stamped and Formed) are manufactured using stamped & formed technology and provide many essential benefits to the customer:

- Stamped & Formed Technology: parts of highest precision due to high reliability in manufacturing process
- Stamped parts (center contact, support sleeve, connector body) delivered on reels
- Suitable for fully automated assembly by harness makers
- Designed for high-volume production, 100 % process reliability
- Significant cost reductions due to fully automated and quicker cable assembly manufacturing processes
- Compatible with FAKRA-RF standard housings due to standardized cavities
- According to USCAR 17 & 18 and ISO 20860-1 & -2

SF center contact, SF support sleeve and SF connector bodies can only be delivered on reels. Information about special tools for packing units and high-volume production is available on request.

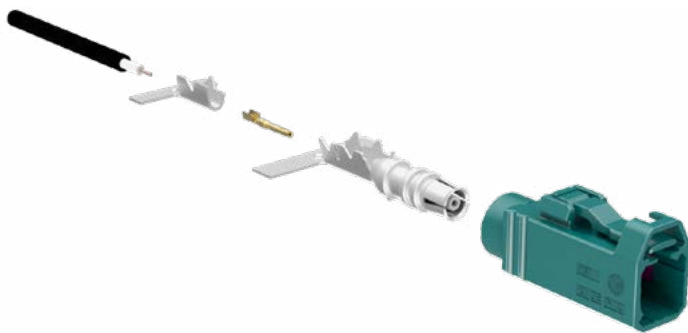

Cable SF support sleeve SF center contact SF connector body Plastic housing

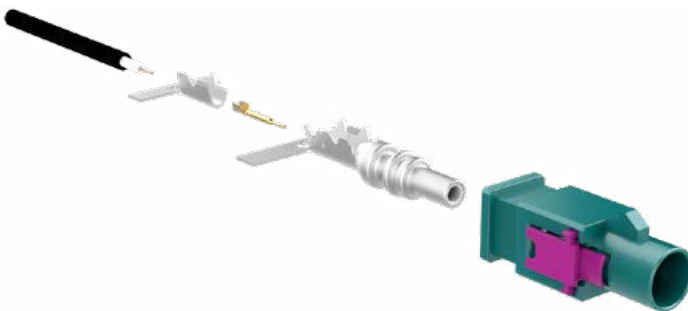

Belting and Packing

Stamped and formed connector parts e.g. outer contacts, inner contacts or sleeves for high volume production can be delivered on reels. Quantities available on request.

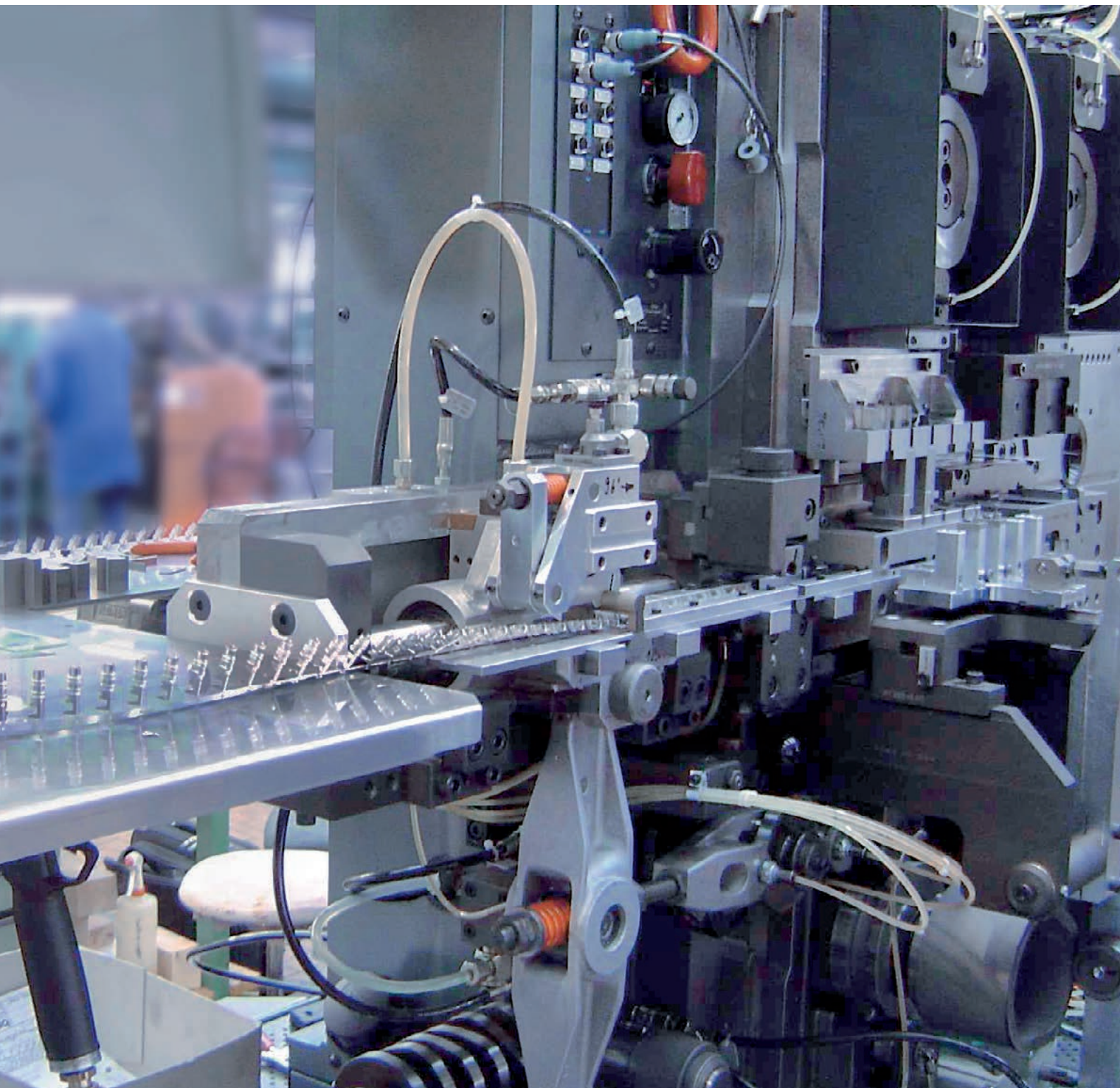

Tape & Reel











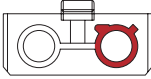



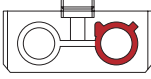



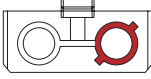



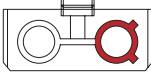



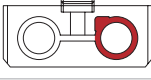



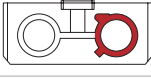

































Some Rosenberger PCB connectors are supplied in rolled packaging (tape&reel) for automatic component placement. Different types of blister tapes are available.

Belting and packaging correspond to IEC 60286-3/EIA-481.

FAKRA Number Code

Connector or Housing only							Connector including Housing
59	K	1	30 -	1	M4	A4	-y
							Coding
							A Black
							B White
							C Blue
							D Bordeaux
							E Green
							F Brown
							G Grey
							H Violet
							I Beige
							K Curry
							L Carmin red
							M Pastel orange
							N Pastel green
							Z Waterblue
							-y Blank coding
							Plating
							01-Z9 Cable group
							00 Blank
							0M Surface mount device
							xx Blank cable group
							1 Crimp
							3 Solder crimp
							4 PCB mounting
							5 Solid center contact
							Successive number
							1 Straight
							2 Right angle
							5 Panel connector with round flange
							K Female, jack
							S Male, plug
							W Tool
							Z Plastic housings and accessories
Connector series, 59 FAKRA							

FAKRA Coding

Coding		Jack		Plug		Color / RAL-No. (Similar)
		Single	Double	Single	Double	
A	Radio without phantom supply					Black/ 9005 
B	Radio with phantom supply					White/ 9001 
C	GPS: telematics or navigation					Blue/ 5005 
D	GSM Cellular phone					Bordeaux/ 4004 
E	TV1					Green/ 6002 
F	TV2					Brown/ 8011 
G	Remote control keyless entry					Grey/ 7031 
H	GPS: telematics and navigation					Violet/ 4003 
I	Radio controlled parking heating					Beige/ 1001 
K	Radio with IF					Curry/ 1027 
L	Not defined					Camine red/ 3002 
M	Not defined					Pastel orange/ 2003 
N	Not defined					Pastel green/ 6019 
Z	Neutral coding					Waterblue/ 5021 

Some of the Rosenberger-FAKRA connectors are available in the above listed codings.
Colors of the plastic housings are in accordance with the listed RAL colours, minor colour differences due to manufacturing are possible.

FAKRA Cable Groups

Cable Group	Impedance	Cable Type
01	50 Ω	RG 178, RG 196
02	50 Ω	RG 316/U, RG 174
02	75 Ω	RG 179
03	75 Ω	RG 179 B/U-d, 1.5DS, 1.5C
06	50 Ω	RG 58
09	75 Ω	RG 59
10	93 Ω	RG 62
BF	50 Ω	e.g. Shikoku 2DS-PPFW
BU	50 Ω	e.g. TFC 5.5
D6	120 Ω	e.g. LEONI Dacar [®] 077
D8	75 Ω	B-75-1.7-2.7
E3	50 Ω	RTK 008
E4	50 Ω	RG 58-LL
E7	61 Ω	B-61-1.87-2.9
H1	50 Ω	RTK 013
M4	50 Ω	RTK 031, RTK 032



FAKRA Plating Code

Outer Contact

Code	Plating (top layer)	Symbol	Layer Thickness	Magnetic Properties
A	Nickel	Ni	min. 3.00 µm	
L	AuroDur®	Au	min. 0.15 µm	Non-magnetic
N	White bronze (e.g. Optalloy®) Flash white bronze over silver (e.g. Optargen®)			Non-magnetic
S	Stainless steel			
T	Tin/Lead loadfree	Sn	min. 1.50-8.00 µm	Non-magnetic
Z	Special materials, see data sheet			

Center Contact

Code	Plating (top layer)	Symbol	Layer Thickness	Magnetic Properties
4	Gold	Au	min. 0.80 µm	
5	AuroDur®	Au	min. 0.15 µm	Non-magnetic

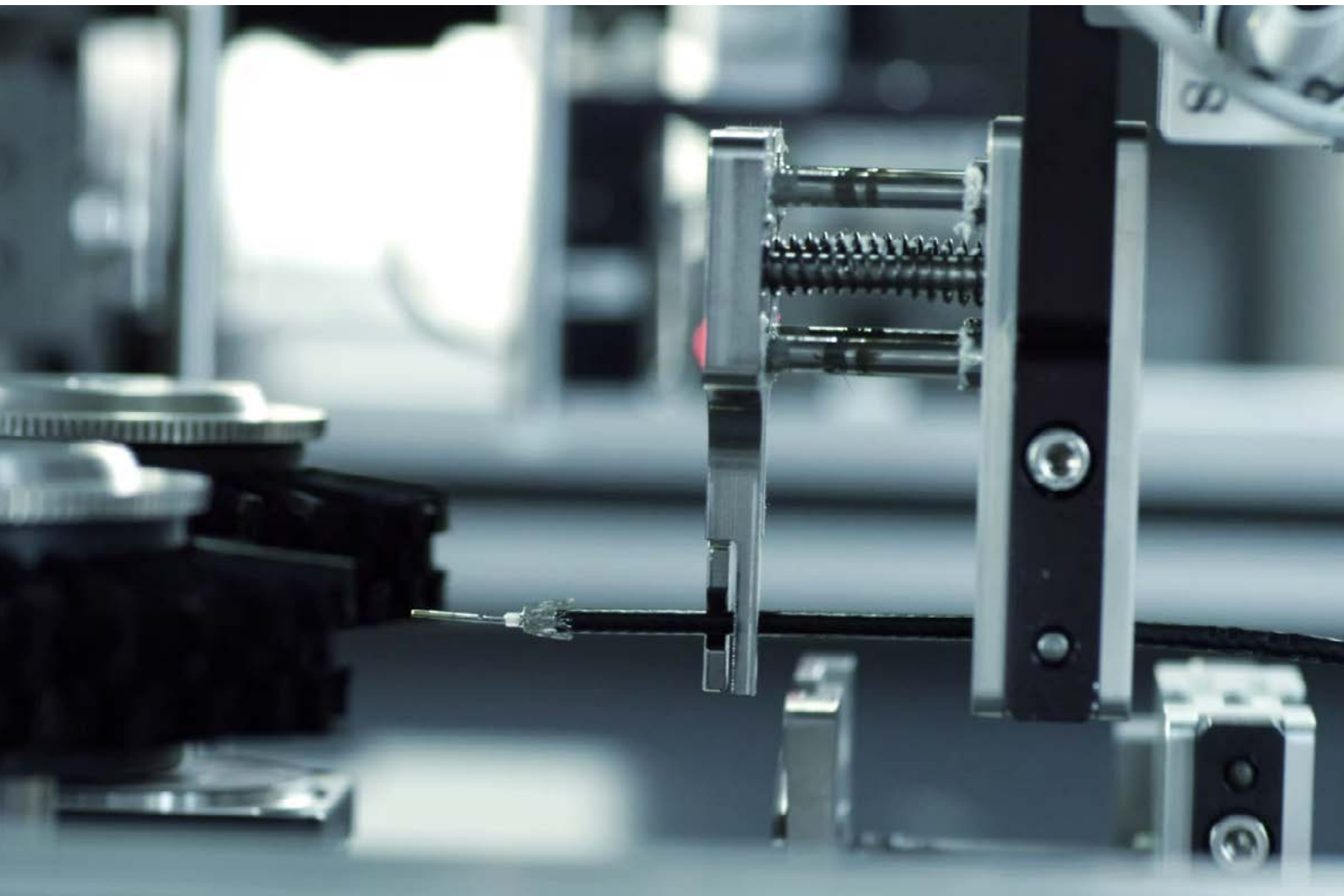

FAKRA Interface Dimensions

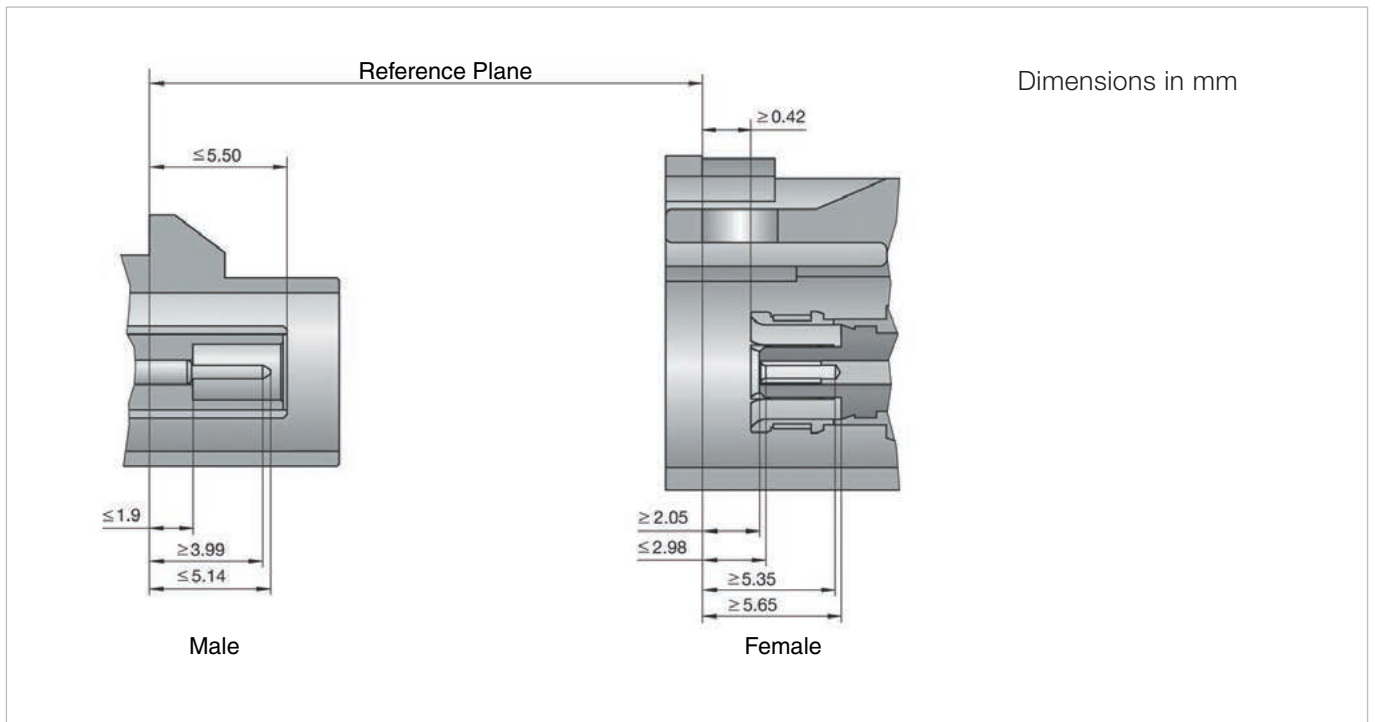

Housing Designs

Single	
Double 8 mm	
Double 12.7 mm	
Quad	

FAKRA Technical Data (Code 59)

Applicable Standards

Interface according to	ISO 20860-1, SAE/USCAR-18
Quality tested according to	ISO 20860-2

Electrical Data

Impedance	50 Ω
Frequency range (depends on cable)	DC to 6 GHz
Return loss	≥ 18 dB
Insertion loss	$\leq 0.1 \times \sqrt{f(\text{GHz})}$ dB
Insulation resistance	$\geq 1 \times 1$ G Ω
Center contact resistance	≤ 5 m Ω
Outer contact resistance	≤ 5 m Ω
Test voltage	750 V rms
Working voltage	335 V rms
Contact current (depending on cable size)	≤ 1 A DC
RF-leakage	≥ 65 dB

Mechanical Data

Mating cycles	≥ 25
Engagement force (single, standard)	≤ 25 N
Disengagement force	≥ 2 N
Retention force latch	≥ 110 N
Retention force primary lock	≥ 80 N
Retention force secondary lock	≥ 60 N

Environmental Data

Temperature range	-40 °C – +105 °C
Vibration/mechanical shock	ISO 20860-2 clause 9.1
Thermal shock	ISO 20860-2 clause 9.2
Temperature/humidity cycling	ISO 20860-2 clause 9.3
High temperature exposure	ISO 20860-2 clause 9.4

Materials

Outer contact	CuZn, CuSn, Zn, Stainless steel
Center contact	CuZn, CuBe, CuSn
Dielectric	PTFE, PA, LCP, PBT
Gasket	Silicone, Rubber
Crimping ferrule	Cu
Plastic housings	PBT, PA, PPE, POM
Secondary lock	PBT, PA, PPE

Platings

Outer contact	Au, Ni, Sn
Center contact	Au

Rosenberger-connectors fulfill in principle the indicated data of the Technical Data. Individual values of connectors may deviate depending upon application, design, type of cable, assembly method and execution. Specific data sheets for particular products can be provided on request from your Rosenberger sales partner.

Cable Connectors & Housings, Straight

Straight Jack, Stamped & Formed Center Contact

Rosenberger No.	Cable	Assy Inst.	Crimping Tool Center Contact	Crimp Insert Outer Contact	Sales Unit	Product
59K13o-102A4	RG 174, RG 316	MA 59 V 059	11W161-800	11W150-302	500, 5000*	
59K13o-103A4	RG 179 B/U-d, 1.5DS	MA 59 V 059	11W161-800	11W15B-503	500, 5000*	
59K13o-106A4	RG 58	MA 59 V 059	11W161-806	11W150-108	500, 5000*	
59K13o-1BFA4	e.g.: Shikoku 2DS-PPFW	MA 59 V 109	11W161-8M4	11W15W-5BA	500, 5000*	
59K13o-1E4A4	RG 58-LL	MA 59 V 059	11W161-8E4	11W150-108	500, 5000*	
59K13o-1E7A4	B-61-1.87-2.9	MA 59 V 059	11W161-800	11W150-302	500, 5000*	
59K13o-1M4A4	RTK 031	MA 59 V 059	11W161-8M4	11W150-104	500, 5000*	

works with all housings at page 24 and 25

* outer contact in box, center contact on reel

Straight Jack, Stamped & Formed Outer and Center Contact

Rosenberger No.	Cable	Assy Inst.	Crimping Tools for FAKRA SF	Sales Unit	Product
59K16B-102T4	RG 174, RG 316	MA 59 V 047	19150013, 19150008, 19150012**	*)	
59K16B-106T4	RG 58	MA 59 V 044	19150017, 19150009, 19150018**	*)	
59K16B-1E4T4	RG 58-LL	MA 59 V 044	19150017, 19150009, 19150018**	*)	
59K16B-1M4T4	RTK 031	MA 59 V 047	19150003, 19150000, 19150002**	*)	

works with all housings at page 24 and 25

* outer, center contact and sleeve on reel separate, quantities on request

** crimping applicator

Straight Jack

Rosenberger No.	Cable	Assy Inst.	Crimping Tool Center Contact	Crimp Insert Outer Contact	Sales Unit	Product
59K17F-102A4	RG 179	MA 59 V 002	11W15A-502	11W15A-502	1000	
59K17F-1D6A4	e.g. Dacar 077	MA 59 V 002	11W15A-508	11W15A-508	1000, 4000	
59K17F-1D8A4	B-75-1.7-2.7	MA 59 V 002	11W15A-502	11W15A-502	1000, 4000	

works with all housings at page 24 and 25







Housing Jack, Double 12.7 mm

Rosenberger No.	Description	Sales Unit	Product
59Z017-000-y	With secondary locking Without slot for positioning clip -y: please fill-in requested coding	150	

Housing Jack, Quad

Rosenberger No.	Description	Sales Unit	Product
59Z076-001-y	Works with connector 59S20Z-40MT5-y -y: please fill-in requested coding	75	

Housing Jack, Single

Rosenberger No.	Description	Sales Unit	Product
59Z063-000-y	With secondary locking Without slot for positioning clip -y: please fill-in requested coding	250	
59Z113-000-y	With secondary locking Without slot for positioning clip -y: please fill-in requested coding	500	
59Z117-000-y	With secondary locking Without slot for positioning clip -y: please fill-in requested coding	400	
59Z117-C01-y	With secondary locking With slot for positioning clip -y: please fill-in requested coding	400	
59Z073-001-y	Without secondary locking Without slot for positioning clip -y: please fill-in requested coding	500	
59Z073-C00-y	Without secondary locking With slot positioning clip -y: please fill-in requested coding	500	

Housing Jack, Double 8 mm

Rosenberger No.	Description	Sales Unit	Product
59Z115-000-y	With secondary locking Without slot for positioning clip -y: please fill-in requested coding	500	
59Z119-000-y	With secondary locking Without slot for positioning clip -y: please fill-in requested coding	500	
59Z119-C01-y	With secondary locking With slot for positioning clip -y: please fill-in requested coding	500	
59Z067-000-y	Without secondary locking Without slot for positioning clip -y: please fill-in requested coding	250	
59Z067-C00-y	Without secondary locking With slot positioning clip -y: please fill-in requested coding	250	

Cable Connectors & Housings, Straight

Straight Jack, Stamped & Formed Center Contact incl. Housing Jack, Single

Rosenberger No.	Description	Cable	Assy Inst.	Crimping Tool Center Contact	Crimp Insert Outer Contact	Sales Unit	Product
59K17H-109A4-y	-y: please fill-in requested coding	RG 59, RG 62	MA 59 V 056 MA 59 V 056	11W161-800 11W161-809	11W150-109 11W150-109	500, 5000* 500, 5000*	

* outer contact in box, center contact on reel

Panel Connectors & Cable Assemblies

Straight Plug, Stamped & Formed Center Contact incl. Housing Plug, Single

Rosenberger No.	Description	Cable	Assy Inst.	Crimping Tool Center Contact	Crimp Insert Outer Contact	Sales Unit	Product
59S50E-102A4-y	Round flange with bracket Without secondary locking -y: please fill-in requested coding	RG 174, RG 316	MA 59 V 068	11W161-800	11W150-302	500, 5000, 20000 outer contact and hous- ing in box, center contact on reel	

Cable Connectors & Housings, Straight

Straight Plug, Stamped & Formed Center Contact

Rosenberger No.	Cable	Assy Inst.	Crimping Tool Center Contact	Crimp Insert Outer Contact	Sales Unit	Product
59S10o-101A4	RG 178, RG 196	MA 59 V 086	S951-050833	11W150-101	500, 5000*	
59S10o-102A4	RG 174, RG 316	MA 59 V 058	11W161-800	11W150-302	500, 5000*	
59S10o-103A4	RG 179 B/U-d, 1.5DS	MA 59 V 058	11W161-800	11W15B-503	500, 5000*	
59S10o-106A4	RG 58	MA 59 V 058	11W161-806	11W150-108	500, 5000*	
59S10o-1E4A4	RG 58-LL	MA 59 V 058	11W161-8E4	11W150-108	500, 5000*	
59S10o-1E7A4	B-61-1.87-2.9	MA 59 V 058	11W161-800	11W150-302	500, 5000*	
59S10o-1M4A4	RTK 031	MA 59 V 058	11W161-8M4	11W150-104	500, 5000*	

works with all housings at page 29

* outer contact in box, center contact on reel

Straight Plug

Rosenberger No.	Cable	Assy Inst.	Crimping Tool Center Contact	Crimp Insert Outer Contact	Sales Unit	Product
59S17E-1D8A4	B-75-1.7-2.7	MA 59 V 010	11W15A-502	11W15A-502	1000, 3000	

works with all housings at page 29

Straight Plug, Stamped & Formed Outer and Center Contact





Rosenberger No.	Cable	Assy Inst.	Crimping Tools for FAKRA SF	Sales Unit	Product
59S16A-102T4	RG 174, RG 316	MA 59 V 046	19150014, 19150012, 19150008**	*)	
59S16A-106T4	RG 58	MA 59 V 043	19150016, 19150018, 19150009**	*)	
59S16A-1E4T4	RG 58-LL	MA 59 V 043	19150016, 19150018, 19150009**	*)	
59S16A-1M4T4	RTK 031	MA 59 V 046	19150001, 19150002, 19150000**	*)	

works with all housings at page 29

* outer, center contact and sleeve on reel separate, quantities on request

** crimping applicator

Housing Plug, Single

Rosenberger No.	Description	Sales Unit	Product
59Z064-000-y	With secondary locking Without slot for positioning clip -y: please fill-in requested coding	500	
59Z114-000-y	With secondary locking Without slot for positioning clip -y: please fill-in requested coding	500	
59Z118-C00-y	With secondary locking With slot for positioning clip -y: please fill-in requested coding	500	
59Z074-000-y	Without secondary locking Without slot for positioning clip -y: please fill-in requested coding	500	
59Z074-C00-y	Without secondary locking With slot for positioning clip -y: please fill-in requested coding	400	

Housing Plug, Double 8 mm

Rosenberger No.	Description	Sales Unit	Product
59Z116-000-y	With secondary locking Without slot for positioning clip -y: please fill-in requested coding	600	
59Z120-000-y	With secondary locking Without slot for positioning clip -y: please fill-in requested coding	500	
59Z120-C00-y	With secondary locking With slot for positioning clip -y: please fill-in requested coding	500	
59Z065-000-y	With secondary locking Without slot for positioning clip -y: please fill-in requested coding	250	

Housing Plug, Double 12.7 mm

Rosenberger No.	Description	Sales Unit	Product
59Z016-000-y	With secondary locking Without slot for positioning clip -y: please fill-in requested coding	200	

Cable Connectors & Housings, Right Angle

Right Angle Jack

Rosenberger No.	Cable	Assy Inst.	Crimping Tool Center Contact	Crimp Insert Outer Contact	Sales Unit	Product
59K28H-102A4	RG 174, RG 316	MA 59 V 042	11W150-402	11W150-402	1000	
59K28H-106A4	RG 58	MA 59 V 042	11W150-506	11W150-506	1000	
59K28H-1E7A4	B-61-1.87-2.9	MA 59 V 042	11W150-402	11W150-402	1000, 5000	
59K28H-1M4A4	RTK 031	MA 59 V 042	11W150-504	11W150-504	1000	

works with all housings at this page

Housing Jack, Single

Rosenberger No.	Description	Sales Unit	Product
59Z066-000-y	Cable down With secondary locking -y: please fill-in requested coding	500	
59Z066-L00-y	Cable left With secondary locking -y: please fill-in requested coding	500	
59Z066-R00-y	Cable right With secondary locking -y: please fill-in requested coding	500	

Housing Jack, Double 8 mm

Rosenberger No.	Description	Sales Unit	Product
59Z027-001-y	Cable down With secondary locking -y: please fill-in requested coding	250	

Housing Jack, Double 12.7 mm

Rosenberger No.	Description	Sales Unit	Product
59Z026-000-y	Cable down With secondary locking -y: please fill-in requested coding	250	

Right Angle Jack and Housing Jack, Single





Rosenberger No.	Description	Cable	Assy Inst.	Crimping Tool Center Contact	Crimp Insert Outer Contact	Sales Unit	Product
59K25H-102A4	360° turnable	RG 174, RG 316	MA 59 V 065	11W150-402	11W150-402	1000	
59K25H-106A4	360° turnable	RG 58	MA 59 V 065	11W150-508	11W150-508	1000	
59K25H-1E4A4	360° turnable	RG 58 LL	MA 59 V 065	11W15F-5E4	11W15F-5E4	1000	
59K25H-1M4A4	360° turnable	RTK 031	MA 59 V 065	11W150-504	11W150-504	1000	
59Z006-T00-y	360° turnable With secondary locking Housing single for 59K25H-1xx -y: please fill-in requested coding					500	

Right Angle Jack, Stamped & Formed Outer and Center Contact incl. Housing, Single

Rosenberger No.	Description	Cable	Assy Inst.	Crimping Tools for FAKRA SF	Sales Unit	Product
59K27D-102Z4-y	360° turnable Without secondary locking Incl. housing single -y: please fill-in requested coding	RG 174, RG 316	MA 59 V 080	19150032, 19150008, 19150012**	850 on reel	
59K27D-1M4Z4-y	360° turnable Without secondary locking Incl. housing single -y: please fill-in requested coding	RTK 031	MA 59 V 080	19150026, 19150002, 19150000**	850 on reel	

** crimping applicator

Right Angle Jack, Stamped & Formed Outer and Center Contact and Housings Jack, Single/Double 8 mm

Rosenberger No.	Description	Cable	Assy Inst.	Crimping Tools for FAKRA SF	Sales Unit	Product
59K26A-1M4Z4	360° turnable	RTK 031	MA 59 V 080 MA 59 V 099	19150026, 19150000, 19150002**	*)	
59Z127-000-y	Cable down With secondary locking Housing double 8 mm for 59K26A-1M4Z4 -y: please fill-in requested coding				250	
59Z143-000-y	Cable down single for 59K26A-1M4Z4 -y: please fill-in requested coding				250	
59Z144-000-y	Cable down double 8 mm for 59K26A-1M4Z4 -y: please fill-in requested coding				250	

* outer, center contact and sleeve on reel separately, quantities on request

** crimping applicator

Cable Connectors & Housings, Waterproof

Straight Jack, Stamped & Formed Center Contact

Rosenberger No.	Cable	Assy Inst.	Crimping Tool Center Contact	Crimp Insert Outer Contact	Sales Unit	Product
59K130-102A4	RG 174, RG 316	MA 59 V 059	11W161-800	11W150-302	500, 5000*	
59K130-106A4	RG 58	MA 59 V 059	11W161-806	11W150-108	500, 5000*	
59K130-1E4A4	RG 58-LL	MA 59 V 059	11W161-8E4	11W150-108	500, 5000*	
59K130-1M4A4	RTK 031	MA 59 V 059	11W161-8M4	11W150-104	500, 5000*	

* outer contact in box, center contact on reel

Straight Jack, Stamped & Formed Outer and Center Contact

Rosenberger No.	Cable	Assy Inst.	Crimping Tools for FAKRA SF	Sales Unit	Product
59K16B-102T4	RG 174, RG 316	MA 59 V 047	19150013, 19150008, 19150012**	*)	
59K16B-106T4	RG 58	MA 59 V 044	19150017, 19150009, 19150018**	*)	
59K16B-1E4T4	RG 58-LL	MA 59 V 044	19150017, 19150018, 19150009**	*)	
59K16B-1M4T4	RTK 031	MA 59 V 047	19150003, 19150000, 19150002**	*)	



* outer, center contact and sleeve on reel separate, quantities on request

** crimping applicator

Housing Jack, Single

Rosenberger No.	Description	Sales Unit	Product
59Z163-003-y	Waterproof Works with connectors, cable seal and cap! Connectors: 59K130-1xxA4 and 59K16B-1xxT4 Required piece parts must be ordered separate! Cable group 02: cable seal 59K14B-102/50 and cap 59Z163-000/51 Cable group E4: cable seal 59K14B-1E4/50 and cap 59Z163-000/56 Cable group M4: cable seal 59K14B-1M4/50 and cap 59Z163-000/51 -y: available codings on request	250	

Right Angle Jack, Stamped & Formed Center Contact incl. Housing

Rosenberger No.	Description	Cable	Assy Inst.	Crimping Tools	Sales Unit	Product
59K24K-102A4-y	Waterproof Cable down*	RG 174, e.g. DACAR 462	MA 59 V 115	On request	On request	
59K24K-1M4A4-y	Waterproof Cable down*	RTK 031	MA 59 V 115	On request	On request	
59K2RK-102A4-y	Waterproof Cable right*	RG 174, e.g. DACAR 462	MA 59 V 115	On request	On request	
59K2RK-1M4A4-y	Waterproof Cable right*	RTK 031	MA 59 V 115	On request	On request	
59K2LK-102A4-y	Waterproof Cable left*	RG 174, e.g. DACAR 462	MA 59 V 115	On request	On request	
59K2LK-1M4A4-y	Waterproof Cable left*	RTK 031	MA 59 V 115	On request	On request	

* -y: please fill-in requested coding

Watertightness can be guaranteed for a mated connection consisting of waterproof Rosenberger connectors according LV 214

Straight Plug, Stamped & Formed Center Contact

Rosenberger No.	Cable	Assy Inst.	Crimping Tool Center Contact	Crimp Insert Outer Contact	Sales Unit	Product
59S10o-102A4	RG 174, RG 316	MA 59 V 058	11W161-800	11W150-302	500, 5000*	
59S10o-106A4	RG 58	MA 59 V 058	11W161-806	11W150-108	500, 5000*	
59S10o-1E4A4	RG 58-LL	MA 59 V 058	11W161-8E4	11W150-108	500, 5000*	
59S10o-1M4A4	RTK 031	MA 59 V 058	11W161-8M4	11W150-104	500, 5000*	

* outer contact in box, center contact on reel

Straight Plug, Stamped & Formed Outer and Center Contact

Rosenberger No.	Cable	Assy Inst.	Crimping Tools for FAKRA SF	Sales Unit	Product
59S16A-102T4	RG 174, RG 316	MA 59 V 046	19150014, 19150012, 19150008**	*)	
59S16A-106T4	RG 58	MA 59 V 043	19150016, 19150018, 19150009**	*)	
59S16A-1E4T4	RG 58-LL	MA 59 V 043	19150016, 19150018, 19150009**	*)	
59S16A-1M4T4	RTK 031	MA 59 V 046	19150001, 19150002, 19150000**	*)	

* outer, center contact and sleeve on reel separate, quantities on request

** crimping applicator

Housing Plug, Single

Rosenberger No.	Description	Sales Unit	Product
59Z176-C01-y	Waterproof Works with connectors, cable seal and cap! Connectors: 59S100-1xxA4 and 59S16A-1xxT4 Required piece parts must be ordered separate! Cable group 02: cable seal 59K14B-102/50 and cap 59Z163-000/51 Cable group E4: cable seal 59K14B-1E4/50 and cap 59Z163-000/56 Cable group M4: cable seal 59K14B-1M4/50 and cap 59Z163-000/51 -y: available codings on request	250	

Additional Piece Parts, Please Order Separate

Rosenberger No.	Description	Cable Group	Product
59K14B-102/50	Cable seal	02	
59K14B-1E4/50	Cable seal	E4	
59K14B-1M4/50	Cable seal	M4	
59Z163-000/51	Cap	02, M4	
59Z163-000/56	Cap	E4	

PCB Connectors Wave Soldering

Straight Plug PCB incl. Housing, Single

Rosenberger No.	Description	Panel Piercing / Footprint	Sales Unit	Product
59S10H-400T5-y	Wave soldering Round pins Pin length 4.00 mm -y: please fill-in requested coding	MB 273	100	

Right Angle Plug PCB incl. Housing, Single



Rosenberger No.	Description	Panel Piercing / Footprint	Sales Unit	Product
59S20X-400T5-y	Wave soldering Coupling nose up Pin length 2.50 mm -y: please fill-in requested coding	MB 190	50 blister 275 tape & reel	

Right Angle Plug PCB incl. Housing, Double Stacked

Rosenberger No.	Description	Panel Piercing / Footprint	Sales Unit	Product
59S2KA-400T5-y	Stacked type -y: please fill-in requested coding	MB 442	770 blister	

PCB Connectors SMD Pin-in-Paste

Straight Plug PCB incl. Housing, Single

Rosenberger No.	Description	Panel Piercing / Footprint	Sales Unit	Product
59S12K-40MT5-y	Pin-in-paste Pin length 2.25 mm -y: please fill-in requested coding	MB 286	320 tape & reel	
59S10M-40MT5-y	Pin-in-paste Pin length 2.30 mm -y: please fill-in requested coding	MB 296	720 blister 135 tape & reel	
59S1AC-40MT5-y	Pin-in-paste Pin length 2.00 mm -y: please fill-in requested coding	MB 244	200 tape & reel	

Straight Plug PCB incl. Housing, Double 8 mm

Rosenberger No.	Description	Panel Piercing / Footprint	Sales Unit	Product
59S14K-40MT5-y	Pin-in-paste Pin length 2.25 mm -y: please fill-in requested coding	MB 506	265 tape & reel	

Straight Plug PCB without Housing for Camera Applications

Rosenberger No.	Description	Panel Piercing / Footprint	Sales Unit	Product
59S13X-40MT5	Custom specific versions on request	MB 495	220 tape & reel	

Right Angle Jack PCB incl. Housing, Single





Rosenberger No.	Description	Panel Piercing / Footprint	Sales Unit	Product
59K23C-40MA5-y	Pin-in-paste Designed for antenna applications -y: please fill-in requested coding	MB 297	1000 blister 200 tape & reel	

PCB Connectors SMD Pin-in-Paste



Right Angle Plug PCB incl. Housing, Single

Rosenberger No.	Description	Panel Piercing / Footprint	Sales Unit	Product
59S2AQ-40MT5-y_1	Pin-in-paste Coupling nose up -y: please fill-in requested coding	MB 172, MB 355	430 tape & reel	
59S2UQ-40MT5-y_1	Pin-in-paste Coupling nose down -y: please fill-in requested coding	MB 172, MB 355	430 tape & reel	
59S2LQ-40MT5-y_1	Pin-in-paste Coupling nose left -y: please fill-in requested coding	MB 172, MB 355	560 tape & reel	
59S2RQ-40MT5-y_1	Pin-in-paste Coupling nose right -y: please fill-in requested coding	MB 172, MB 355	560 tape & reel	
59S20K-40MT5-y	Pin-in-paste Coupling nose up -y: please fill-in requested coding	MB 601	300 tape & reel	
59S2UK-40MT5-y	Pin-in-paste Coupling nose down -y: please fill-in requested coding	MB 601	300 tape & reel	
59S2LK-40MT5-y	Pin-in-paste Coupling nose left -y: please fill-in requested coding	MB 601	300 tape & reel	
59S2RK-40MT5-y	Pin-in-paste Coupling nose right -y: please fill-in requested coding	MB 601	300 tape & reel	

Right Angle Plug PCB incl. Housing, Single

Rosenberger No.	Description	Panel Piercing / Footprint	Sales Unit	Product
59S2PL-40MT5-y	Pin-in-paste Coupling nose up -y: please fill-in requested coding	On request	250 tape & reel	
59S2UL-40MT5-y	Pin-in-paste Coupling nose down -y: please fill-in requested coding	On request	250 tape & reel	
59S2LL-40MT5-y	Pin-in-paste Coupling nose left -y: please fill-in requested coding	On request	250 tape & reel	
59S2RL-40MT5-y	Pin-in-paste Coupling nose right -y: please fill-in requested coding	On request	250 tape & reel	

Right Angle Plug PCB incl. Housing, Double 8 mm

Rosenberger No.	Description	Panel Piercing / Footprint	Sales Unit	Product
59S2DA-40MT5-y	Pin-in-paste Coupling nose up -y: please fill-in requested coding	MB 182	300 tape & reel	
59S2DU-40MT5-y	Pin-in-paste Coupling nose down -y: please fill-in requested coding	MB 182	300 tape & reel	
59S2MU-40MT5-y	Pin-in-paste Coupling nose down -y: please fill-in requested coding	MB 447	300 tape & reel	
59S20M-40MT5-y	Pin-in-paste Coupling nose up y: please fill-in requested coding	MB 602	240 tape & reel	

Rosenberger No.	Description	Panel Piercing / Footprint	Sales Unit	Product
59S20Z-40MT5-y	Pin-in-paste Coupling nose down -y: please fill-in requested coding	MB 426	160 tape & reel	

Right Angle Plug PCB incl. Housing, 4-way, Stacked 12.7 mm

Rosenberger No.	Description	Panel Piercing / Footprint	Sales Unit	Product
59S2QF-40MT5-y-y-y-y	Pin-in-paste 4-way Stacked type -y: please fill-in requested coding	MB 696	On request	

Right Angle Plug 3-4-5-way

Rosenberger No.	Description	Panel Piercing / Footprint	Sales Unit	Product
59S2MC-40MT5	3-4-5-way Available on request Only mateable with 59K2MP-40MT5	MB 563	145 tape & reel	

Right Angle Jack PCB incl. Housing, 5-way, Board-to-Board

Rosenberger No.	Description	Panel Piercing / Footprint	Sales Unit	Product
59K2MP-40MT5	5-way 5 x board-to-board connection Die cast Only mateable with 59S2MC-40MA5	MB 555	210 tape & reel	

FAKRA Calibration Kit



Electrical Specifications

Calibration Standard	Frequency Range in GHz	Parameter	Specification
Opens ¹ (plug and jack)	DC to ≤ 4 GHz > 4 GHz to ≤ 6 GHz	Error from Nominal phase	$\leq 1.0^\circ$ $\leq 1.5^\circ$
Shorts ¹ (plug and jack)	DC to ≤ 4 GHz > 4 GHz to ≤ 6 GHz	Error from Nominal phase	$\leq 1.0^\circ$ $\leq 1.5^\circ$
Calibration loads (plug and jack)	DC to ≤ 4 GHz > 4 GHz to ≤ 6 GHz	Return loss	≥ 40 dB ≥ 35 dB
Calibration adaptors RPC-3.50 to FAKRA (plug/plug, plug/jack, jack/plug, jack/jack)	DC to ≤ 1 GHz > 1 GHz to ≤ 3 GHz > 3 GHz to ≤ 6 GHz	Return loss	≥ 35 dB ≥ 26 dB ≥ 21 dB

¹ The specifications for opens and shorts are given as allowed deviation from nominal model as defined in calibration certificate included with your kit.

Calibration Kit, Full Version

Rosenberger No.	Description	Product
59CK010-150	<p>Rosenberger calibration kits are delivered in stable wooden boxes including factory calibration certificate.</p> <p>Please use the following part numbers for ordering single components.</p>	

Contents of Calibration Kit

Rosenberger No.	Description	Quantity
03S12L-00FS3	Open circuit plug, RPC-3.50	1
03K12L-00FS3	Open circuit jack, RPC-3.50	1
03S12S-00FS3	Short circuit plug, RPC-3.50	1
03K12S-00FS3	Short circuit jack, RPC-3.50	1
03S150-F10S3	Calibration load plug, RPC-3.50	1
03K150-F10S3	Calibration load jack, RPC-3.50	1
03K159-S20S3	Calibration adaptor, RPC-3.50 jack / FAKRA plug	1
03K159-K20S3	Calibration adaptor, RPC-3.50 jack / FAKRA jack	1
03S159-S20S3	Calibration adaptor, RPC-3.50 plug / FAKRA plug	1
03S159-K20S3	Calibration adaptor, RPC-3.50 plug / FAKRA jack	1
03W008-000	Combi wrench	1
03W021-000	Torque wrench	1
59Z114-000Z	Plastic housing plug	10
59Z113-000Z	Plastic housing jack	10

Hand Crimping Tools for Turned Parts

Crimping Tool

Rosenberger No.	Description	Sales Unit	Product
11W150-000	MIL-STD-22520/5 Without crimp insert Choose crimp inserts 11W150-xxx	1	

Crimp Inserts for Outer Contact Crimp only

for 11W150-000

Rosenberger No.	Description	Sales Unit	Product
11W150-102	Width outer contact 3.30 mm	1	
11W150-104	Width outer contact 4.30 mm	1	
11W150-108	Width outer contact 5.50 mm	1	
11W150-109	Width outer contact 6.50 mm	1	
11W150-302	Width outer contact 3.30 mm	1	
11W15B-503	Width outer contact 3.30 mm	1	
11W15W-5BA	Width outer contact 5.35 mm	1	

Crimp Inserts for Outer & Center Contact Crimp

for 11W150-000





Rosenberger No.	Description	Sales Unit	Product
11W150-402	Width outer contact 3.30 mm, center contact 0.73 mm	1	
11W15A-502	Width outer contact 3.30 mm, center contact 1.20 mm	1	
11W150-504	Width outer contact 4.30 mm, center contact 1.10 mm	1	
11W15A-504	Width outer contact 4.30 mm, center contact 1.10 mm	1	
11W150-506	Width outer contact 5.35 mm, center contact 1.10 mm	1	
11W150-508	Width outer contact 5.50 mm, center contact 1.10 mm	1	
11W15A-508	Width outer contact 5.50 mm, center contact 1.10 mm	1	
11W15F-5E4	Width outer contact 5.50 mm, center contact 1.30 mm	1	

Hand Crimping Tools for FAKRA SF – Stamped and Formed

Crimping Tool for Center Contacts only

Rosenberger No.	Description	Sales Unit	Product
11W161-801	for RG 178, RTK 013 Crimping height 0.74 ± 0.03	1	
11W161-800	for RG 174 U Crimping height 0.78 ± 0.03	1	
11W161-8M4	for RTK 031 Crimping height 0.88 ± 0.03	1	
11W161-806	for RG 58 Crimping height 0.95 ± 0.03	1	
11W161-8E4	for RG 58 LL Crimping height 1.10 ± 0.03	1	
11W161-809	for RG 62	1	

Repair Tool for Housings

Rosenberger No.	Description	Sales Unit	Product
59W007-000	Insert for basic tool for replacing right angle housings (59K27D-102Z4-y, 59K27D-1M4Z4-y)	1	
59W008-000	Insert for basic tool for replacing straight housings (59Z074-000-y, 59Z073-001-y, 59Z073-C00-y, 59Z067-C00-y)	1	
59W010-000	Basic tool small	1	
59W011-000	Basic tool large	1	

Applicators including Crimping Tools for FAKRA SF – Outer & Center Contact

Cable RTK 031, Cable Group M4

Rosenberger No.	Description	Sales Unit	Product
19150001	Applicator for Stamped & Formed Outer Contact straight male	1	
19150003	Applicator for Stamped & Formed Outer Contact straight female	1	
19150026	Applicator for Stamped & Formed Outer Contact right angle female	1	
19150000	Applicator for Stamped & Formed Center Contact straight male/female	1	
19150002	Applicator for Stamped & Formed Sleeve male/female	1	

Cable RG 174, RG 316, Cable Group 02 | RG 179 B/U-d, 1.5DS, Cable Group 03

Rosenberger No.	Description	Sales Unit	Product
19150014	Applicator for Stamped & Formed Outer Contact straight male	1	
19150013	Applicator for Stamped & Formed Outer Contact straight female	1	
19150032	Applicator for Stamped & Formed Outer Contact right angle female	1	
19150008	Applicator for Stamped & Formed Center Contact straight male/female	1	
19150012	Applicator for Stamped & Formed Sleeve male/female	1	

Cable RG 58, Cable Group 06 | Cable RG 58-LL, Cable Group E4

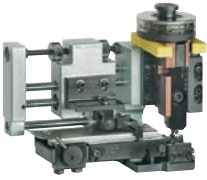
Rosenberger No.	Description	Sales Unit	Product
19150016	Applicator for Stamped & Formed Outer Contact straight male	1	
19150017	Applicator for Stamped & Formed Outer Contact straight female	1	
19150009	Applicator for Stamped & Formed Center Contact straight male/female	1	
19150018	Applicator for Stamped & Formed Sleeve male/female	1	

Cable RG 59, Cable Group 09

Rosenberger No.	Description	Sales Unit	Product
19150011	Applicator for Stamped & Formed Outer Contact straight male	1	
19150006	Applicator for Stamped & Formed Outer Contact straight female	1	
19150031	Applicator for Stamped & Formed Center Contact straight male/female	1	
19150005	Applicator for Stamped & Formed Sleeve male/female	1	

Cable RG 62, Cable Group 10

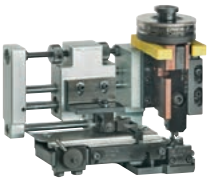
Rosenberger No.	Description	Sales Unit	Product
19150011	Applicator for Stamped & Formed Outer Contact straight male	1	
19150006	Applicator for Stamped & Formed Outer Contact straight female	1	
19150007	Applicator for Stamped & Formed Center Contact straight male/female	1	
19150005	Applicator for Stamped & Formed Sleeve male/female	1	

Applicators including Crimping Tools for Center Contact & Support Sleeve

Cable RTK 031, Cable Group M4

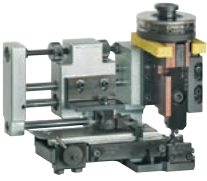
Rosenberger No.	Description	Sales Unit	Product
11WM009	Crimp Insert for Outer Contact right angle female	1	
11WB011_A01	Applicator for Stamped & Formed Center Contact right angle female	1	
11WR013_A01	Applicator for Stamped & Formed Sleeve male/female	1	

Cable RG 174, RG 316, Cable Group 02

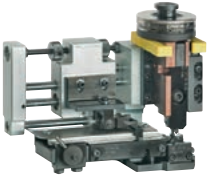
Rosenberger No.	Description	Sales Unit	Product
11WM008	Crimp Insert for Outer Contact right angle female	1	
11WB010_A01	Applicator for Stamped & Formed Center Contact right angle female	1	
11WR012_A01	Applicator for Stamped & Formed Sleeve male/female	1	

Cable RG 58-LL, Cable Group E4

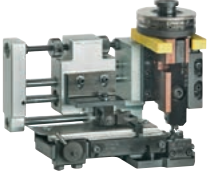
Rosenberger No.	Description	Sales Unit	Product
11WM010	Crimp Insert for Outer Contact straight female	1	
11WS001_A01	Applicator for Stamped & Formed Center Contact straight female	1	
11WR014_A01	Applicator for Stamped & Formed Sleeve male/female	1	

Cable TFC 5.5, Cable Group BU

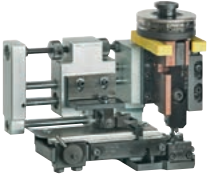
Rosenberger No.	Description	Sales Unit	Product
11WM011	Crimp Insert for Outer Contact straight female	1	
11WS002_A01	Applicator for Stamped & Formed Center Contact straight female	1	
11WR015_A01	Applicator for Stamped & Formed Sleeve male/female	1	

Rosenberger No.

19150000	42	11W150-302	40
19150001	42	11W150-402	40
19150002	42	11W150-504	40
19150003	42	11W150-506	40
19150005	42	11W150-508	40
19150006	42	11W15A-502	40
19150007	42	11W15A-504	40
19150008	42	11W15A-508	40
19150009	42	11W15B-503	40
19150011	42	11W15F-5E4	40
19150012	42	11W15W-5BA	40
19150013	42	11W161-800	41
19150014	42	11W161-801	41
19150016	42	11W161-806	41
19150017	42	11W161-809	41
19150018	42	11W161-8E4	41
19150026	42	11W161-8M4	41
19150031	42	11WB010_A01	43
19150032	42	11WB011_A01	43
03K12L-00FS3	39	11WM008	43
03K12S-00FS3	39	11WM009	43
03K150-F10S3	39	11WM010	43
03K159-K20S3	39	11WM011	43
03K159-S20S3	39	11WR012_A01	43
03S12L-00FS3	39	11WR013_A01	43
03S12S-00FS3	39	11WR014_A01	43
03S150-F10S3	39	11WR015_A01	43
03S159-K20S3	39	11WS001_A01	43
03S159-S20S3	39	11WS002_A01	43
03W008-000	39	59CK010-150	39
03W021-000	39	59K13o-102A4	24, 32
11W150-000	40	59K13o-103A4	24
11W150-102	40	59K13o-106A4	24, 32
11W150-104	40	59K13o-1BFA4	24
11W150-108	40	59K13o-1E4A4	24, 32
11W150-109	40	59K13o-1E7A4	24



59K13o-1M4A4	24, 32
59K14B-102/50	33
59K14B-1E4/50	33
59K14B-1M4/50	33
59K16B-102T4	24, 32
59K16B-106T4	24, 32
59K16B-1E4T4	24, 32
59K16B-1M4T4	24, 32
59K17F-102A4	24
59K17F-1D6A4	24
59K17F-1D8A4	24
59K17H-109A4-y	26
59K23C-40MA5-y	35
59K24K-102A4-y	32
59K24K-1M4A4-y	32
59K25H-102A4	31
59K25H-106A4	31
59K25H-1E4A4	31
59K25H-1M4A4	31
59K26A-1M4Z4	31
59K27D-102Z4-y	31
59K27D-1M4Z4-y	31
59K28H-102A4	30
59K28H-106A4	30
59K28H-1E7A4	30
59K28H-1M4A4	30
59K2LK-102A4-y	32
59K2LK-1M4A4-y	32
59K2MP-40MT5	37
59K2RK-102A4-y	32
59K2RK-1M4A4-y	32
59S10H-400T5-y	34
59S10M-40MT5-y	35
59S10o-101A4	28
59S10o-102A4	28, 33
59S10o-103A4	28

59S10o-106A4	28, 33
59S10o-1E4A4	28, 33
59S10o-1E7A4	28
59S10o-1M4A4	28, 33
59S12K-40MT5-y	35
59S13X-40MT5	35
59S14K-40MT5-y	35
59S16A-102T4	28, 33
59S16A-106T4	28, 33
59S16A-1E4T4	28, 33
59S16A-1M4T4	28, 33
59S17E-1D8A4	28
59S1AC-40MT5-y	35
59S20K-40MT5-y	36
59S20M-40MT5-y	37
59S20X-400T5-y	34
59S20Z-40MT5-y	37
59S2AQ-40MT5-y_1	36
59S2DA-40MT5-y	37
59S2DU-40MT5-y	37
59S2KA-400T5-y	34
59S2LK-40MT5-y	36
59S2LL-40MT5-y	36
59S2LQ-40MT5-y_1	36
59S2MC-40MT5	37
59S2MU-40MT5-y	37
59S2PL-40MT5-y	36
59S2QF-40MT5-y-y-y-y	37
59S2RK-40MT5-y	36
59S2RL-40MT5-y	36
59S2RQ-40MT5-y_1	36
59S2UK-40MT5-y	36
59S2UL-40MT5-y	36
59S2UQ-40MT5-y_1	36
59S50E-102A4-y	27
59W007-000	41
59W008-000	41
59W010-000	41
59W011-000	41
59Z006-T00-y	31
59Z016-000-y	29
59Z017-000-y	24
59Z026-000-y	30
59Z027-001-y	30
59Z063-000-y	25
59Z064-000-y	29
59Z065-000-y	29
59Z066-000-y	30
59Z066-L00-y	30
59Z066-R00-y	30
59Z067-000-y	25
59Z067-C00-y	25
59Z073-001-y	25
59Z073-C00-y	25
59Z074-000-y	29
59Z074-C00-y	29
59Z076-001-y	25
59Z113-000-y	25
59Z113-000Z	39
59Z114-000-y	29
59Z114-000Z	39
59Z115-000-y	25
59Z116-000-y	29
59Z117-000-y	25
59Z117-C01-y	25
59Z118-C00-y	29
59Z119-000-y	25
59Z119-C01-y	25
59Z120-000-y	29
59Z120-C00-y	29
59Z127-000-y	31
59Z143-000-y	31
59Z144-000-y	31
59Z163-000/51	33
59Z163-000/56	33
59Z163-003-y	32
59Z176-C01-y	33





Website

For more information refer to our website:
www.rosenberger.com/fakra

Rosenberger

Rosenberger Hochfrequenztechnik GmbH & Co. KG

Hauptstraße 1 | 83413 Fridolfing

P.O. Box 1260 | 84526 Tittmoning

Germany

Phone +49 8684 18-0

info@rosenberger.com

www.rosenberger.com

Certified by IATF 16949 · DIN EN 9100 · ISO 9001 · ISO 14001

Order No.

pA 135543 · Info201FAKRACat

2000/2018

Rosenberger® is a registered trademark of Rosenberger Hochfrequenztechnik GmbH & Co. KG.
All rights reserved.

© Rosenberger 2018