

INDEX

SPECIFICATIONS	4
MIL-DTL-32139 / NANO-D	10
DUAL ROW	14
SINGLE ROW	74
MOUNTING HARDWARE & TOOLS	104
CONNECTOR SAVERS	105
PANEL MOUNT CUTOUT	106

THE FLEX PIN

Omnetics' groundbreaking Flex Pin contact design pre-dates the advent of the MIL-DTL-32139 nano-miniature specification and today all MIL-DTL-32139 sockets mate properly with the Flex Pin. The one-piece unit is stamped from ASTM B194 beryllium copper (BeCu) to deliver high conductivity, low interference, and high resiliency. Its excellent spring properties enable it to withstand shock, vibration, and other rugged conditions and it easily passes military specification requirements.

Flex Pin contacts are plated with 50 micro-inches (1.27 μ m) of gold over 50 micro-inches (1.27 μ m) of nickel and are rated at 1 amp each. All pins are plated post-forming to verify a no raw edges surface. Our contacts are inspected by our quality assurance experts to guarantee perfection and performance.

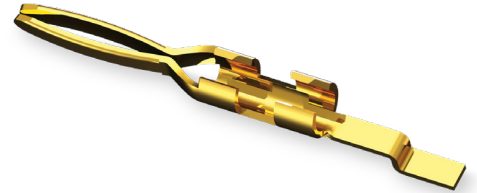

Many high-reliability applications have scaled down to meet size, weight and power (SWaP) goals, and the Flex Pin has evolved too. Omnetics has taken a unique approach to this industry-wide phenomenon. While many Nano-D manufacturers simply reduced an existing standard, Omnetics reengineered the Flex Pin to improve the design's performance in our smaller Bi-Lobe[®] package sizes. The Nano Flex Pin features an elegant one-piece design that eliminates the extra crimp welds seen in many overly complex twist pins. Eliminating these excess resistance points helps ensure strength and reliability at every scale. Omnetics' gold-plated Nano Flex Pins are the rugged and reliable foundation of our Bi-Lobe[®] and MIL-DTL-32139 series of connectors.



SPACE LEVEL SCREENING
 [PER EEE-INST-002]

Ordering steps

Step 1 - Choose a suitable Micro or Nano connector

Step 2 - Choose a level of Space Screening

Level 1 - Mission Critical (Highest Reliability)

Level 2 - High Reliability

Level 3 - Standard Reliability

Step 3 - Select any added outgassing processing needed.

Step 4 - Select Qualification Level.

Step 5 - Specify chosen Ordering Codes from table below.

These codes should be used as separate line items on all Quote Requests and Purchase Orders as required.



Ordering Codes (quoted as separate line items)

Test Level	Ordering Codes	Processing for Outgassing
Screening Level 1 - Mission Critical	SPT1	All standard materials exhibit less than 1.0% TML without additional processing. Contact service for special requirements.
Screening Level 2 - High Reliability	SPT2	
Screening Level 3 - Standard Reliability		
Qualification Level 1	QT1	
Qualification Level 2	QT2	
Qualification Level 3	QT3	

Table 1: Screening Requirements

Inspection / Test	Nano (.025" center)	
	Level 1 Com'l/SCD	Level 2 Com'l/SCD
Visual	100%	100%
Mechanical	2 (0)	2 (0)
Voltage Rating (DWV)	100%	2 (0)
Insulation Resistance	2 (0)	2 (0)
Temperature Cycling	2 (0)	2 (0)
Low Level Contact Resistance	2 (0)	2 (0)
Mating / Unmating Force	2 (0)	-
Solderability / Resistance to Heat (SMT & Thru-Hole only)	2 (0)	-



Table 2: Qualifications For Nano-D Connectors

Inspection / Test	Test Methods, Conditons, Requirements	Quantity		
		Level 1	Level 2	Level 3
Visual	Insert / Insulator Body	3 (0)	2 (0)	
	Contact Positioning			
	Shell / Body			
	Threads			
	Adhesives / Molding Material			
	Leads			
Mechanical	Dimensions per Catalog	3 (0)	2 (0)	
Dielectric Withstanding Voltage (Sea Level)	MIL-DTL-32139, Para 4.8.7.1 EIA-364-20, Test Condition I	3 (0)		
Insulation Resistance	MIL-DTL-32139, Para 4.7.7 EIA-364-21	3 (0)	2 (0)	
Temperature Cycling	MIL-DTL-32139, Para 4.7.13 EIA-364-32, Test Condition I	3 (0) **	2 (0) **	
Low Signal Level Contact Resistance	MIL-DTL-32139, Para 4.7.16 EIA-364-23	3 (0)	2 (0)	
Contact Engagement & Separation Forces	MIL-DTL-32139, Para 4.7.5	3 (0)		
Contact Retention / Wire Retention	MIL-DTL-32139, Para 4.7.18 EIA-364-29	3 (0)		
Solderability & Resistance to Soldering Heat	MIL-STD-202-208 MIL-DTL-32139, EIA-364-56	3 (0) **		
Mating & Unmating Force	MIL-DTL-32139, Para 3.7.3	2 (0)	3 (0)	
Shock	MIL-DTL-32139, Para 4.7.11 EIA-364-27	2 (0) **	3 (0) *	
Vibration	MIL-DTL-32139, Para 4.7.10 EIA-364-28	3 (0) **		
Evaluaiion of Material Outgassing Properties	ASTM E595 (125°C, 24Hrs)	*	*	

* Omnetics connectors within the scope of this document meet the outgassing requirements of M32139 and no additional baking is required.

** Destructive tests require additional samples which will be added to the order by Omnetics.

BI-LOBE® / NANO-D AND MIL-DTL-32139 SPECIFICATIONS

1. SCOPE

Omnetics Bi-Lobe® and MIL-DTL-32139 series of nano-D connectors are precision-engineered to meet or exceed MIL-DTL-32139 specifications. These nano-miniature connectors feature tightly-packed contacts with centerlines of 0.025" (.64 mm). Our mission is to provide designers of high-reliability and critical systems with dependable and compliant components, whether they choose QPL or non-QPL versions.

2. PRECEDENCE OF REQUIREMENTS

The specifications herein are a select summary of those called out in MIL-DTL-32139. The complete controlled version of MIL-DTL-32139 from DLA takes precedence over these pages. For non-QPL parts, requirements of customer specifications and Omnetics' detail drawings will take top priority.

3. QUALITY & MATERIAL

3.1. Statistical Process Control (SPC)

Omnetics uses statistical process control (SPC) techniques, when possible, in the manufacturing of Bi-Lobe® nano connectors. The SPC program is maintained in accordance with MIL-STD-790. Where SPC cannot be utilized because of non-continuous production, a lot sampling plan for inspection with C = 0 (accept on zero defects) may be utilized. The SPC and C = 0 programs are documented and maintained as part of our overall reliability assurance program, as specified in MIL-STD-790.

3.2. Pin Contact Finish

Pin contacts are gold plated in accordance with ASTM B488, Type II, Code C, Class 1. 27, 50 micro inches minimum thickness, over 50 μinches of nickel minimum.

3.3. Socket Contact Finish

Socket contacts are gold plated in accordance with ASTM B488, Type II, Code C, Class 1. 27, 50 micro inches minimum thickness, over 50 μinches of nickel minimum.

3.4. Insulator Material

Insulator material for connectors is LCP in accordance with ASTM D5138.

3.5. Shells

Shell options include the following materials:

3.5.1. Aluminum, alloy 6061 per SAE-AMS-QQ-A-200/8 or ASTM B221, plated as follows:

3.5.1.1. Electroless Nickel plated (500 micro inches MIN) per

SAE-AMS-C-2404, class 4.

3.5.1.2. Cadmium plated per SAE-AMS-QQ-P-416, type II, class 1, yellow chromate.

3.5.2. Stainless Steel, 303 in accordance with ASTM A582, passivated per AMS2700 Type II.

3.5.3. Titanium, 6Al-4V in accordance with MIL-T-81556 or SAE-AMS-4911.

3.6. Encapsulant

Epoxy shall be used as a potting material to prevent contact removal. A suitable material shall be used to enable the connector to pass all required mechanical, environmental and electrical testing.

3.7. Pigtail Wire

Insulated wire shall be in accordance with SAE-AS22759/33, DLA drawing 04047 or NEMA HP3 for size 30 AWG. (NOTE: Connectors, which are pre-wired with SAE- AS22759/33 and stored in a sealed environment, could experience corrosion. Omnetics takes this into consideration when packaging and storing connectors using this wire.

4. MECHANICAL REQUIREMENTS

4.1. Contact Wipe

All contacts have a minimum contact wipe of .015 inch (0.38 mm) prior to the connector halves arriving at their fully mated position.

4.2. Durability

MIL-DTL-32139 requires a minimum of 200 mating cycles per test procedure EIA-364-09. Omnetics easily passes this requirement and has conducted and passed internal testing of over 2,000 mating cycles.

4.3. Contact Retention

Contacts will withstand a 2 lb. (0.9 kg) axial load for a min. of 5 seconds.

4.4. Crimp Tensile Strength

30 AWG wire will not break or pull from crimp joints with an applied force of less than 1.0 lb. (0.44 kg).

4.5. Contact Engaging and Separation Force

Maximum engagement force is 5.0 ounces (141.7 g.) and minimum separation force is 0.4 ounces (11.3 g.) (when using maximum and minimum ID test sleeves.)

4.6. Connector Mating/Unmating Force

BI-LOBE[®] / NANO-D AND MIL-DTL-32139 SPECIFICATIONS

Maximum mating and unmating force will be less than or equal to 7 ounces (198.4 g.) times the number of contacts.

4.7. Solderability

Printed circuit tails intended for SMT and Thru-Hole soldering will meet the solderability requirements of MIL-STD-202, Method 208.

5. ELECTRICAL REQUIREMENTS

5.1. Current Capability

Contacts can carry 1.0 amp in continuous operation from -55° C to 125 ° C.

5.2. Dielectric Withstanding Voltage (sea Level)

Connectors will show no signs of breakdown or flash over at 250 VAC, rms 60 Hz, per the DWV test of EIA-364-20.

5.3. Dielectric Withstanding Voltage (70,000 Feet)

Connectors will show no signs of breakdown or flash over at 100 VAC, rms 60 Hz, per the DWV test of EIA-364-20.

5.4. Insulation Resistance

5,000 Megohms minimum @ 100 VDC per IAW EIA-364-21

5.5. Contact Resistance

71 mV drop maximum with a 1 ampere test current in accordance with EIA-364-06 using 30 AWG stranded wire.

5.6. Low Level Contact Resistance

71 milliohms with a test current of 10 milliamperes maximum in accordance with EIA-364-06.

5.7. Magnetic Permeability

The magnetic permeability will not exceed 2 mu when tested in accordance with EIA-364-54.

6. ENVIRONMENTAL REQUIREMENTS

6.1. Shock

100 g's when tested for mechanical shock, mated connectors shall not be damaged, and there shall be no loosening of parts. There shall be no interruptions in the circuit which lasts longer than 10 nanoseconds.

6.2. Vibration

20 g's when tested for vibration, mated connectors shall not be damaged, and there shall be no loosening of parts. There

shall be no interruptions in the circuit which lasts longer than 10 nanoseconds.

6.3. Salt Spray (Corrosion)

Mated connectors will show no exposure of base metal due to corrosion which will affect performance after be subjected to the salt spray test of EIA-364-26 condition B. Connectors must withstand 48 hours of salt spray. Following the test all connectors shall meet the specified requirements for low-signal level contact resistance and connector mating and unmating forces.

6.4. Thermal Vacuum Outgassing

These connector assemblies shall have a maximum total mass loss (TML) of 1.0 percent of the original specimen mass, and shall have a maximum volatile condensable material (VCM) content of 0.1 percent of the original specimen mass.

6.5. Fluid Immersion

Connectors will continue to adhere to the mating force requirements set forth by MIL-DTL-32139 after be subjected to a 20 hour immersion in synthetic lubricating oil, 2 hour immersion in Perchloroethylene cleaning solvent and 1 hour immersion in coolant fluid. There will be no degradation of the insulators or encapsulates.

6.6. Material Fungus Resistance

Materials used in the construction of these connectors are fungus inert in accordance with ASTM G21.

6.7. Thermal Shock

Connectors will withstand 5 cycles of thermal shock from -55° C to 125 ° C per EIA-364-32, condition I. There will be no detrimental damage or degradation of the electrical performance.

6.8. Humidity

These connectors will meet all the humidity testing requirements in accordance with EIA-364-31, test condition A (excluding steps 7a & 7b). Post humidity, the connectors will pass a 250 VAC DWV test. Within 1 hour the connectors will pass a 1 megohm insulation resistance test. Following 24 hours, the connectors will pass a 1,000 megohm insulation resistance test.

6.9. Marking Permanency

Any marking on the connector shells of these nano connectors shall meet the requirements of MIL-STD-202, Method 215.

SINGLE ROW

Omnetics' pre-wired single-row Bi-Lobe® / Nano-D connectors offer designers maximum flexibility with an extensive range of size, material, hardware, and wire options. This small and powerful connector delivers excellent performance under rigorous conditions.

It can be ordered with full Qualified Products List (QPL) approval to provide the quality assurance, standards adherence, and ease of approvals needed for many high-reliability applications. Commercial off-the-shelf (COTS) non-QPL versions are also available with 18" of color-coded 30 AWG Teflon wire suitable for a wide variety of applications.

Omnetics' Pre-Wired Single-Row Bi-Lobe® / Nano-D connectors are available in standard sizes ranging from 5 through 51 positions.



Electro-Mechanical Specifications

TYPE	PERFORMANCE
Durability	200 Mating Cycles min
Temperature	-55°C to +125 °C
Current rating	1 Amp per contact
Voltage Rating (DWV)	250 VAC RMS Sea Level
Insulation Resistance	5,000 Megohms min
Shock	100 g's discontinuity < 1 microsecond
Vibration	20 g's discontinuity < 1 microsecond
Thermal Vacuum Outgassing	1.0% max TML, 0.1% max VCM
Contact Resistance	71 mV drop @ 1 amp
Mating/Unmating Force	7 oz. (198 g) max per contact

Material Specifications

TYPE	PERFORMANCE
Shell Material and Finish	Aluminum Shell, Electroless Nickel plated Aluminum Shell, Cadmium plated Titanium Shell Unplated Stainless Steel Shell, Passivated
Insulator	Liquid Crystal Polymer (LCP)
Pin	Gold Plated BeCu
Socket	Gold Plated Copper Alloy
Encapsulant	Epoxy

SINGLE ROW QPL ORDERING GUIDE



1 Component Assembly	MBPS-01 Plug, Pin Contacts MBSS-02 Receptacle, Socket Contacts
2 Number Of Contacts	A 9 Contacts B 15 Contacts C 21 Contacts D 25 Contacts E 31 Contacts F 37 Contacts G 51 Contacts
3 Wire Type	See M32139 Wire Type Table Below
4 Hardware	S Jackscrew M32139-01 Plug Only T Threaded Hole M32139-02 Receptacle Only
5 Shell Material And Finish	C Aluminum, Cadmium Finish N Aluminum, Electroless Nickel Finish S Stainless Steel, Passivated Finish T Titanium (Unplated)
6 Space Class	Leave Blank For Non-Space Applications S Space Grade

M32139 Wire Type

Wire Type	Specification	Color	Length Inches [mm]
01	NEMA HP-3-ETXBBB	White	6 [152]
02			18 [457]
03			36 [914]
04		10 Color Repeat	6 [152]
05			18 [457]
06			36 [914]
07	M22759/33-30	White	6 [152]
08			18 [457]
09			36 [914]
10		10 Color Repeat	6 [152]
11			18 [457]
12			36 [914]
13	04047-30A	White	6 [152]
14			18 [457]
15			36 [914]
16		10 Color Repeat	6 [152]
17			18 [457]
18			36 [914]

DUAL ROW

Omnetics' pre-wired dual-row Bi-Lobe[®] / Nano-D connectors are available in an extensive range of size, material, hardware, and wire options. This small and powerful connector delivers exceptional connectivity in critical applications.

These connectors can be ordered with full Qualified Products List (QPL) approval to provide the quality assurance, standards adherence, and ease of approvals needed for many high-reliability applications. Commercial off-the-shelf (COTS) non-QPL versions are also available with 18" of color-coded 30 AWG Teflon wire suitable for a wide variety of applications.

Omnetics' pre-wired single-row Bi-Lobe[®] / Nano-D connectors are available in standard sizes ranging from 9 through 85 positions.

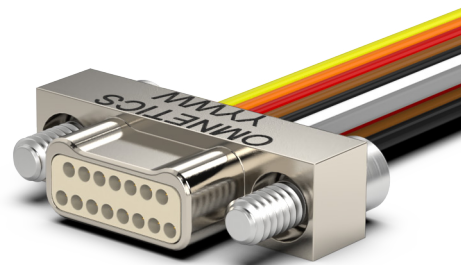

Electro-Mechanical Specifications

TYPE	PERFORMANCE
Durability	200 Mating Cycles min
Temperature	-55°C to +125 °C
Current rating	1 Amp per contact
Voltage Rating (DWV)	250 VAC RMS Sea Level
Insulation Resistance	5,000 Megohms min
Shock	100 g's discontinuity < 1 microsecond
Vibration	20 g's discontinuity < 1 microsecond
Thermal Vacuum Outgassing	1.0% max TML, 0.1% max VCM
Contact Resistance	71 mV drop @ 1 amp
Mating/Unmating Force	7 oz. (198 g) max per contact

Material Specifications

TYPE	PERFORMANCE
Shell Material and Finish	Aluminum Shell, Electroless Nickel plated Aluminum Shell, Cadmium plated Titanium Shell Unplated Stainless Steel Shell, Passivated
Insulator	Liquid Crystal Polymer (LCP)
Pin	Gold Plated BeCu
Socket	Gold Plated Copper Alloy
Encapsulant	Epoxy

DUAL ROW QPL ORDERING GUIDE



1 Component Assembly	MNPO-03 Plug, Pin Contacts MNSO-04 Receptacle, Socket Contacts
2 Number Of Contacts	A 9 Contacts B 15 Contacts C 21 Contacts D 25 Contacts E 31 Contacts F 37 Contacts G 51 Contacts
3 Wire Type	See M32139 Wire Type Table Below
4 Hardware	S Jackscrew M32139-01 Plug Only T Threaded Hole M32139-02 Receptacle Only
5 Shell Material And Finish	C Aluminum, Cadmium Finish N Aluminum, Electroless Nickel Finish S Stainless Steel, Passivated Finish T Titanium (Unplated)
6 Space Class	Leave Blank For Non-Space Applications S Space Grade

M32139 Wire Type

Wire Type	Specification	Color	Length Inches [mm]
01	NEMA HP-3-ETXBBB	White	6 [152]
02			18 [457]
03			36 [914]
04		10 Color Repeat	6 [152]
05			18 [457]
06			36 [914]
07	M22759/33-30	White	6 [152]
08			18 [457]
09			36 [914]
10		10 Color Repeat	6 [152]
11			18 [457]
12			36 [914]
13	04047-30A	White	6 [152]
14			18 [457]
15			36 [914]
16		10 Color Repeat	6 [152]
17			18 [457]
18			36 [914]

DUAL ROW HORIZONTAL SMT (TYPE AA)

Horizontal SMT Bi-Lobe® extremely low-profile connectors are well-suited for pick and place mounting methods. SMT Bi-Lobe® nano connectors feature Omnetics' highly reliable gold-plated Flex Pin contact system. In addition to ease of assembly, their lightweight construction helps meet size and weight goals. They are rugged and deliver high performance under shock, vibration, temperature extremes, and other rigorous conditions common to critical applications. Omnetics' SMT Bi-Lobe® nano connectors are available in a range of options, including mounting holes suitable for PCB and flex mounting. They are available in standard sizes ranging from 9 through 91 positions, as well as custom configurations.



Electro-Mechanical Specifications

TYPE	PERFORMANCE
Durability	> 2000 Mating Cycles min
Temperature	-55°C to +125 °C (200 °C w/HTE)
Current rating	1 Amp per contact
Voltage Rating (DWV)	250 VAC RMS Sea Level
Insulation Resistance	5,000 Megohms @ 100 VDC
Shock	100 g's discontinuity < 10 nanoseconds
Vibration	20 g's discontinuity < 10 nanoseconds
Thermal Vacuum Outgassing	1.0% max TML, 0.1% VCM
Contact Resistance	87 milliohms (87 mV) max @ 1 Amp
Mating/Unmating Force	2.5 oz. (.71g) typical per contact

Material Specifications

TYPE	PERFORMANCE
Contact	Copper Alloy Per MIL-DTL-32139
Contact Finish	Gold per ASTM B488, Type II, Class 1.27, Code C Over Nickel Underplate
Insulator	LCP Per MIL-DTL-32139 Or PEEK
Encapsulant	Epoxy

Shell Options

TYPE	PERFORMANCE
Aluminum 6061	Electroless Nickel per SAE-AMS-2404
Stainless Steel, 300 Series	Passivated per SAE-AMS-2700

DUAL ROW HORIZONTAL SMT (TYPE AA)

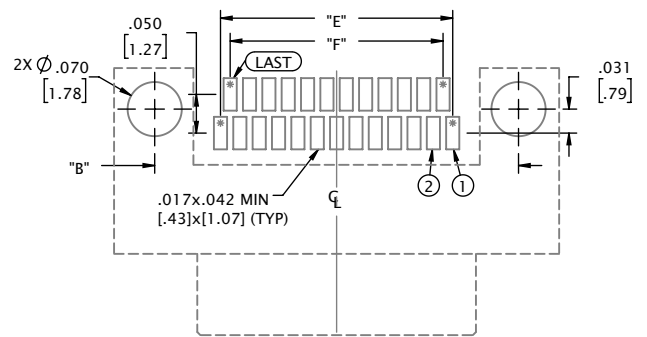
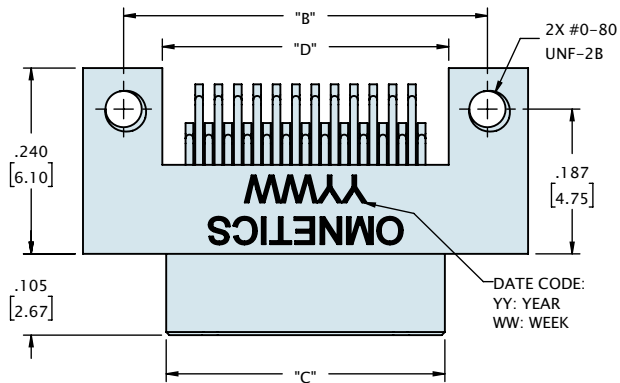
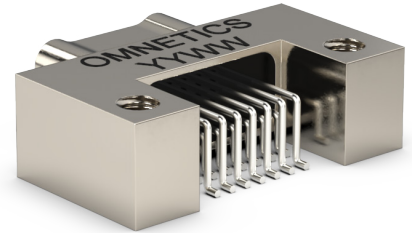
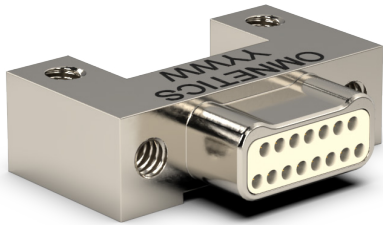

SUGGESTED PAD LAYOUT
(VIEW FROM MOUNTING SIDE OF BOARD)

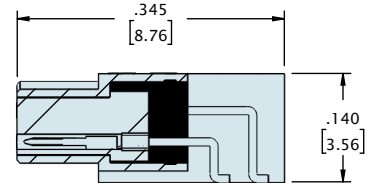
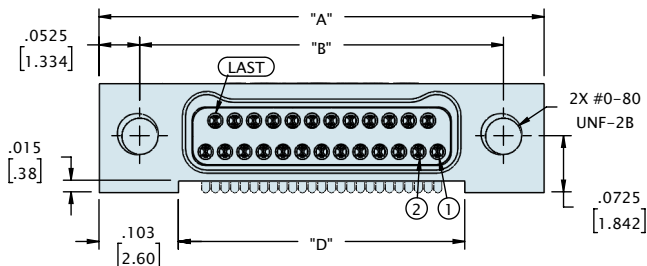

CONTACTS	"A"	"B"	"C"	"D"	"E"	"F"
09	.375 [9.53]	.270 [6.86]	.160 [4.06]	.170 [4.32]	.100 [2.54]	.075 [1.90]
15	.450 [11.43]	.345 [8.76]	.235 [5.97]	.245 [6.22]	.175 [4.44]	.150 [3.81]
21	.525 [13.34]	.420 [10.67]	.310 [7.87]	.320 [8.13]	.250 [6.35]	.225 [5.71]
25	.575 [14.61]	.470 [11.94]	.360 [9.14]	.370 [9.40]	.300 [7.62]	.275 [6.98]
31	.650 [16.51]	.545 [13.84]	.435 [11.05]	.445 [11.30]	.375 [9.52]	.350 [8.89]
37	.725 [18.42]	.620 [15.75]	.510 [12.95]	.520 [13.21]	.450 [11.43]	.425 [10.79]
51	.900 [22.86]	.795 [20.19]	.685 [17.40]	.695 [17.65]	.625 [15.87]	.600 [15.24]
65	1.075 [27.31]	.970 [24.64]	.860 [21.84]	.870 [22.10]	.800 [20.32]	.775 [19.68]
69	1.125 [28.58]	1.020 [25.91]	.910 [23.11]	.920 [23.37]	.850 [21.59]	.825 [20.95]
85	1.325 [33.66]	1.220 [30.99]	1.110 [28.19]	1.120 [28.45]	1.050 [26.67]	1.025 [26.03]
91	1.452 [36.88]	1.321 [33.55]	1.185 [30.10]	1.195 [30.35]	1.125 [28.57]	1.100 [27.94]

DIMENSIONS IN [] ARE IN MILLIMETERS AND ARE FOR REFERENCE ONLY

DUAL ROW HORIZONTAL SMT (TYPE AA)

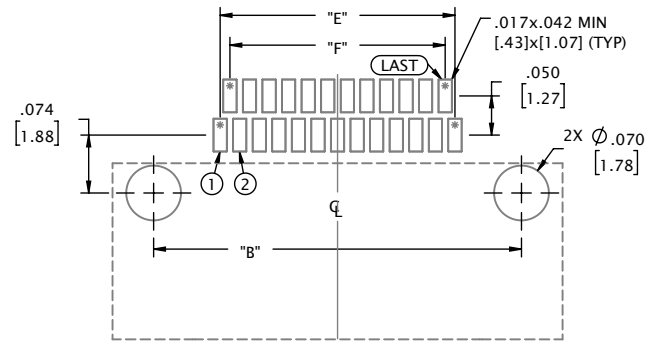
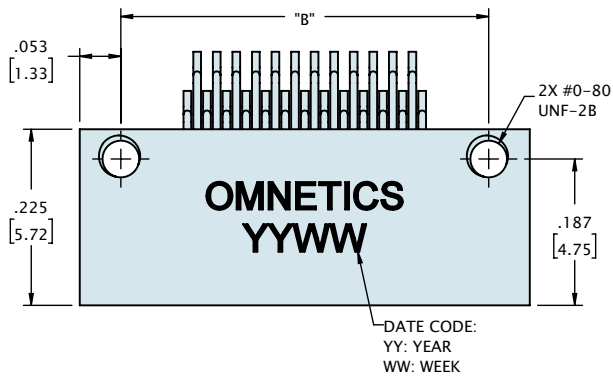
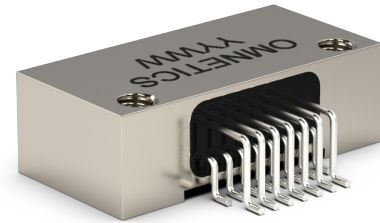

SUGGESTED PAD LAYOUT
(VIEW FROM MOUNTING SIDE OF BOARD)

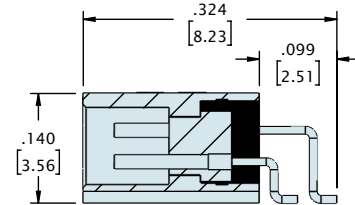
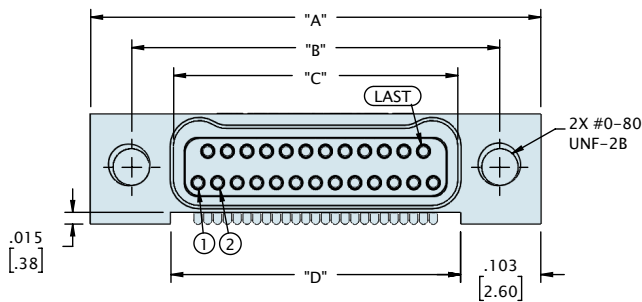

CONTACTS	"A"	"B"	"C"	"D"	"E"	"F"
09	.375 [9.53]	.270 [6.86]	.163 [4.14]	.170 [4.32]	.100 [2.54]	.075 [1.91]
15	.450 [11.43]	.345 [8.76]	.238 [6.05]	.245 [6.22]	.175 [4.45]	.150 [3.81]
21	.525 [13.34]	.420 [10.67]	.313 [7.95]	.320 [8.13]	.250 [6.35]	.225 [5.72]
25	.575 [14.61]	.470 [11.94]	.363 [9.22]	.370 [9.40]	.300 [7.62]	.275 [6.99]
31	.650 [16.51]	.545 [13.84]	.438 [11.13]	.445 [11.30]	.375 [9.53]	.350 [8.89]
37	.725 [18.42]	.620 [15.75]	.513 [13.03]	.520 [13.21]	.450 [11.43]	.425 [10.80]
51	.900 [22.86]	.795 [20.19]	.688 [17.48]	.695 [17.65]	.625 [15.88]	.600 [15.24]
65	1.075 [27.31]	.970 [24.64]	.863 [21.92]	.870 [22.10]	.175 [4.45]	.150 [3.81]
69	1.125 [28.58]	1.020 [25.91]	.913 [23.19]	.920 [23.37]	.850 [21.59]	.825 [20.96]
85	1.325 [33.66]	1.220 [30.99]	1.113 [28.27]	1.120 [28.45]	1.050 [26.67]	1.025 [26.04]
91	1.452 [36.88]	1.321 [33.55]	1.188 [30.18]	1.195 [30.35]	1.125 [28.58]	1.100 [27.94]

DIMENSIONS IN [] ARE IN MILLIMETERS AND ARE FOR REFERENCE ONLY

ORDERING GUIDE



1 Series	MNPO Metal Nano Pin Offset	MNSO Metal Nano Socket Offset
2 Number Of Contacts	09 15 21 25 31 37 51	65 69 85 91
3 Termination Type	AA Horizontal Surface Mount	
4 Shell Material & Finish	N Aluminium Shell, Electroless Nickel Plated B Aluminium Shell, Black Anodized T Titanium Shell, Unplated	CD Aluminium shell, Cadmium Plated S Stainless Steel Shell, Passivated
5 Common Options	ETH End Threaded Hole, #0-80 NTH Non-Threaded Holes For Mounting To The Board YY Non Standard Hardware (threaded holes, thumb screws, #2-56 screw) HT High Temp. Epoxy CS Customer Supplied Material	
6 Mod Codes	M10 Custom Keying M53 Space Grade Nano-D, SPT2	M50 Space Grade Nano-D, SPT1
7 Special Instructions	YYY Describe anything that is not covered in standard options	

DUAL ROW VERTICAL SMT (TYPE VV)

As electronic devices scale down, Omnetics is ready with ever-smaller connectors designed to offer exceptional performance in reduced package sizes. Our **Vertical SMT Bi-Lobe®** nano connectors require minimal board space on flex circuits and printed circuit boards. These connectors feature Omnetics' highly reliable Flex Pin contact system and are available with threaded mounting holes and retention screws. Omnetics' Vertical SMT Type VV Bi-Lobe® nano connectors are available in a wide range of configurations to meet the needs of a variety of critical applications. These connectors are available in standard sizes ranging from 9 through 91 positions, as well as custom configurations.

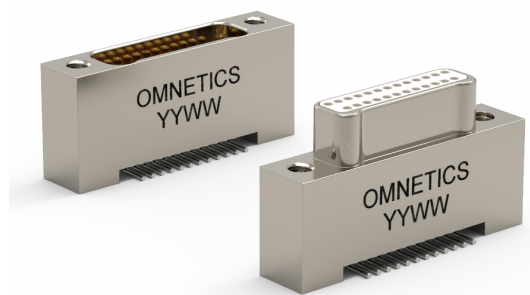

Electro-Mechanical Specifications

TYPE	PERFORMANCE
Durability	> 2000 Mating Cycles min
Temperature	-55°C to +125 °C (200 °C w/HTE)
Current rating	1 Amp per contact
Voltage Rating (DWV)	250 VAC RMS Sea Level
Insulation Resistance	5,000 Megohms @ 100 VDC
Shock	100 g's discontinuity < 10 nanoseconds
Vibration	20 g's discontinuity < 10 nanoseconds
Thermal Vacuum Outgassing	1.0% max TML, 0.1% VCM
Contact Resistance	87 milliohms (87 mV) max @ 1 Amp
Mating/Unmating Force	2.5 oz. (.71g) typical per contact

Material Specifications

TYPE	PERFORMANCE
Contact	Copper Alloy Per MIL-DTL-32139
Contact Finish	Gold per ASTM B488, Type II, Class 1.27, Code C Over Nickel Underplate
Insulator	LCP Per MIL-DTL-32139 Or PEEK
Encapsulant	Epoxy

Shell Options

TYPE	PERFORMANCE
Aluminum 6061	Electroless Nickel per SAE-AMS-2404
Stainless Steel, 300 Series	Passivated per SAE-AMS-2700

DUAL ROW VERTICAL SMT (TYPE VV)

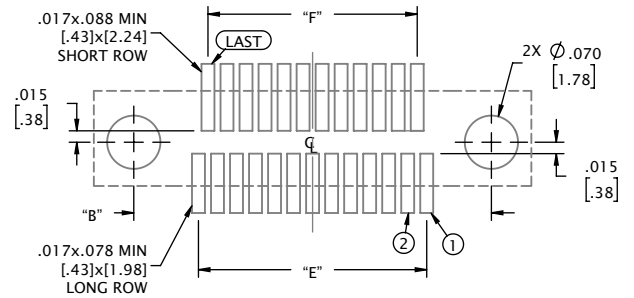
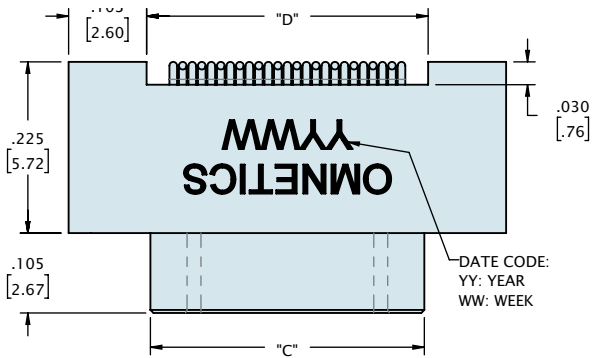
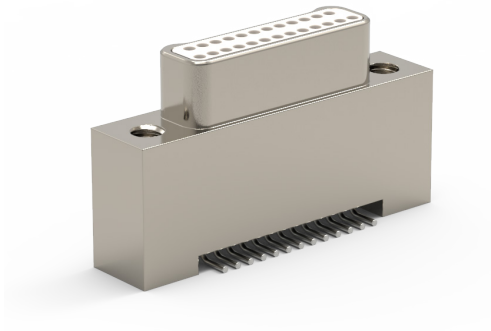

SUGGESTED PAD LAYOUT
(VIEW FROM MOUNTING SIDE OF BOARD)

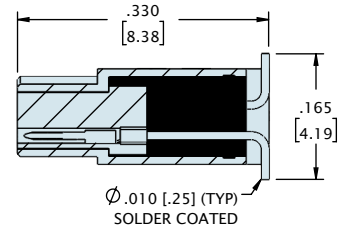
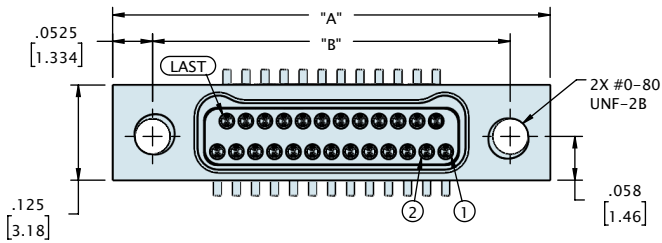

CONTACTS	"A"	"B"	"C"	"D"	"E"	"F"
09	.375 [9.53]	.270 [6.86]	.160 [4.06]	.170 [4.32]	.100 [2.54]	.075 [1.91]
15	.450 [11.43]	.345 [8.76]	.235 [5.97]	.245 [6.22]	.175 [4.45]	.150 [3.81]
21	.525 [13.34]	.420 [10.67]	.310 [7.87]	.320 [8.13]	.250 [6.35]	.225 [5.72]
25	.575 [14.61]	.470 [11.94]	.360 [9.14]	.370 [9.40]	.300 [7.62]	.275 [6.99]
31	.650 [16.51]	.545 [13.84]	.435 [11.05]	.445 [11.30]	.375 [9.53]	.350 [8.89]
37	.725 [18.42]	.620 [15.75]	.510 [12.95]	.520 [13.21]	.450 [11.43]	.425 [10.80]
51	.900 [22.86]	.795 [20.19]	.685 [17.40]	.695 [17.65]	.625 [15.88]	.600 [15.24]
65	1.075 [27.31]	.970 [24.64]	.860 [21.84]	.870 [22.10]	.800 [20.32]	.775 [19.69]
69	1.125 [28.58]	1.020 [25.91]	.910 [23.11]	.920 [23.37]	.850 [21.59]	.825 [20.96]
85	1.325 [33.66]	1.220 [30.99]	1.110 [28.19]	1.120 [28.45]	1.050 [26.67]	1.025 [26.04]
91	1.452 [36.88]	1.321 [33.55]	1.185 [30.10]	1.195 [30.35]	1.125 [28.58]	1.100 [27.94]

DIMENSIONS IN [] ARE IN MILLIMETERS AND ARE FOR REFERENCE ONLY

DUAL ROW VERTICAL SMT (TYPE VV)

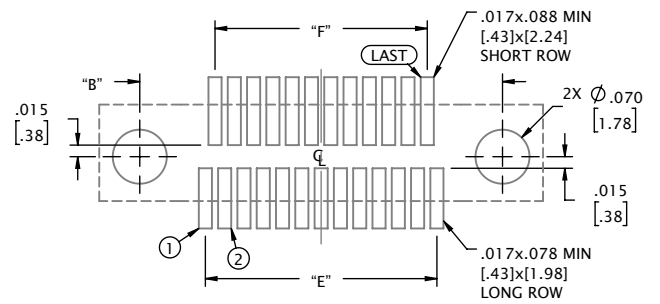
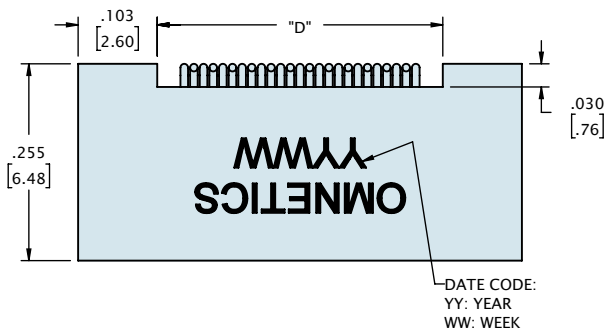
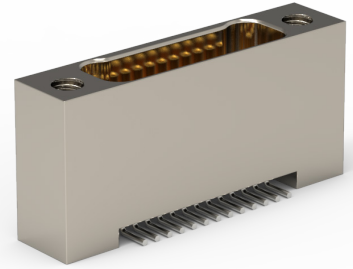
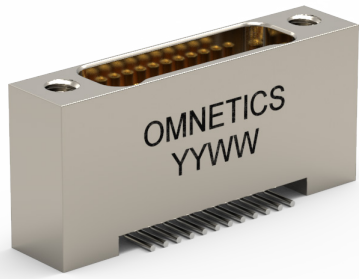

SUGGESTED PAD LAYOUT
(VIEW FROM MOUNTING SIDE OF BOARD)

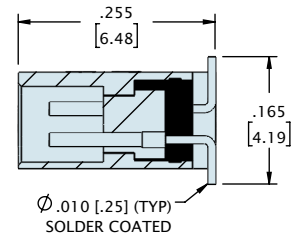
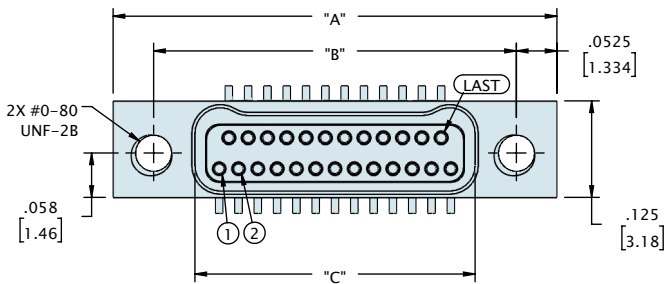

CONTACTS	"A"	"B"	"C"	"D"	"E"	"F"
09	.375 [9.53]	.270 [6.86]	.163 [4.14]	.170 [4.32]	.100 [2.54]	.075 [1.91]
15	.450 [11.43]	.345 [8.76]	.238 [6.05]	.245 [6.22]	.175 [4.45]	.150 [3.81]
21	.525 [13.34]	.420 [10.67]	.313 [7.95]	.320 [8.13]	.250 [6.35]	.225 [5.72]
25	.575 [14.61]	.470 [11.94]	.363 [9.22]	.370 [9.40]	.300 [7.62]	.275 [6.99]
31	.650 [16.51]	.545 [13.84]	.438 [11.13]	.445 [11.30]	.375 [9.53]	.350 [8.89]
37	.725 [18.42]	.620 [15.75]	.513 [13.03]	.520 [13.21]	.450 [11.43]	.425 [10.80]
51	.900 [22.86]	.795 [20.19]	.688 [17.48]	.695 [17.65]	.625 [15.88]	.600 [15.24]
65	1.075 [27.31]	.970 [24.64]	.863 [21.92]	.870 [22.10]	.800 [20.32]	.775 [19.69]
69	1.125 [28.58]	1.020 [25.91]	.913 [23.19]	.920 [23.37]	.850 [21.59]	.825 [20.96]
85	1.325 [33.66]	1.220 [30.99]	1.113 [28.27]	1.120 [28.45]	1.050 [26.67]	1.025 [26.04]
91	1.452 [36.88]	1.321 [33.55]	1.188 [30.18]	1.195 [30.35]	1.125 [28.58]	1.100 [27.94]

DIMENSIONS IN [] ARE IN MILLIMETERS AND ARE FOR REFERENCE ONLY

ORDERING GUIDE

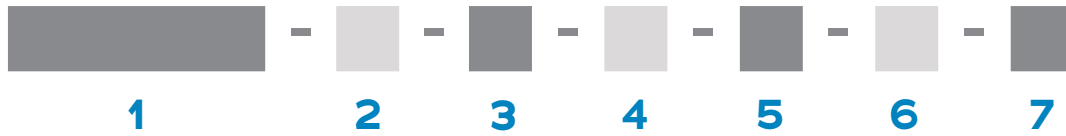

1 Series	MNPO Metal Nano Pin Offset	MNSO Metal Nano Socket Offset
2 Number Of Contacts	09 15 21 25 31 37 51 65 69 85 91	
3 Termination Type	VV Vertical Surface Mount	
4 Shell Material & Finish	N Aluminium Shell, Electroless Nickel Plated B Aluminium Shell, Black Anodized T Titanium Shell, Unplated	CD Aluminium shell, Cadmium Plated S Stainless Steel Shell, Passivated
5 Common Options	ETH End Threaded Hole, #0-80 NTH Non-Threaded Holes For Mounting To The Board YY Non Standard Hardware (threaded holes, thumb screws, #2-56 screw) HT High Temp. Epoxy CS Customer Supplied Material	
6 Mod Codes	M10 Custom Keying M53 Space Grade Nano-D, SPT2	M50 Space Grade Nano-D, SPT1
7 Special Instructions	YYY Describe anything that is not covered in standard options	

DUAL ROW STRAIGHT TAIL (TYPE DD)

The Dual Row Bi-Lobe[®] nanos are tiny and powerful, with ruggedized features that make them suitable for high-reliability applications in medical, military, and other rigorous environments. They feature straight tails (integral or crimped) for vertical thru-hole mounting to fine pitch flex circuits. Straight solid tails are commonly used in ultra-fine wire wrap terminations, such as in electrophysiology applications. The connectors are designed on .025" (.64 mm) centerlines and feature Omnetics' gold-plated Flex Pin contact system. They are available with retention screws for a positive lock and come in standard sizes ranging from 9 to 85 positions. Custom configurations are also available.

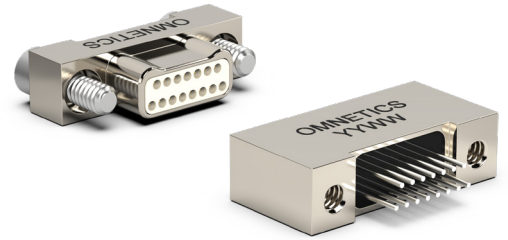

Electro-Mechanical Specifications

TYPE	PERFORMANCE
Durability	> 2000 Mating Cycles min
Temperature	-55°C to +125 °C (200 °C w/HTE)
Current rating	1 Amp per contact
Voltage Rating (DWV)	250 VAC RMS Sea Level
Insulation Resistance	5,000 Megohms @ 100 VDC
Shock	100 g's discontinuity < 10 nanoseconds
Vibration	20 g's discontinuity < 10 nanoseconds
Thermal Vacuum Outgassing	1.0% max TML, 0.1% VCM
Contact Resistance	71 milliohms (71 mV) max @ 1 Amp
Mating/Unmating Force	2.5 oz. (.71g) typical per contact

Material Specifications

TYPE	PERFORMANCE
Contact	Copper Alloy Per MIL-DTL-32139
Contact Finish	Gold per ASTM B488, Type II, Class 1.27, Code C Over Nickel Underplate
Insulator	LCP Per MIL-DTL-32139 Or PEEK
Encapsulant	Epoxy

Shell Options

TYPE	PERFORMANCE
Aluminum 6061	Electroless Nickel per SAE-AMS-2404
Stainless Steel, 300 Series	Passivated per SAE-AMS-2700

DUAL ROW STRAIGHT TAIL (TYPE DD)

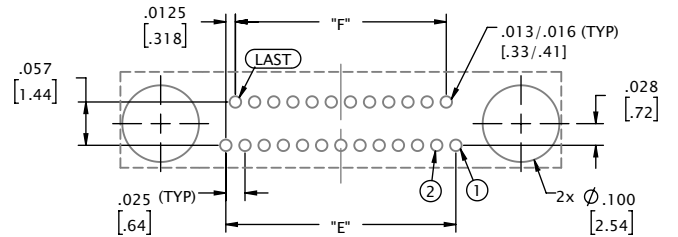
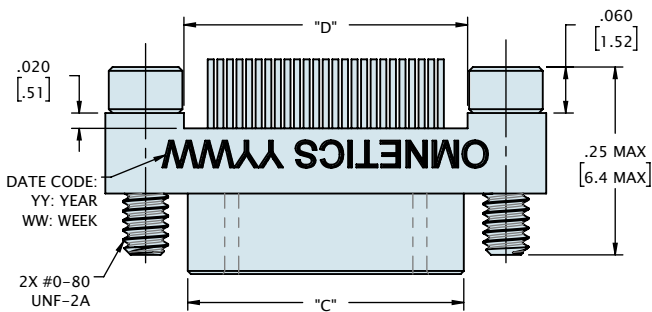
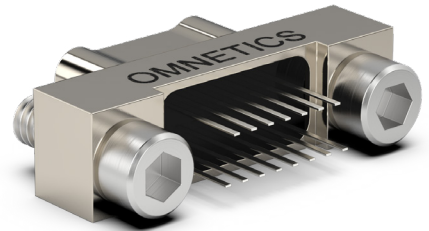
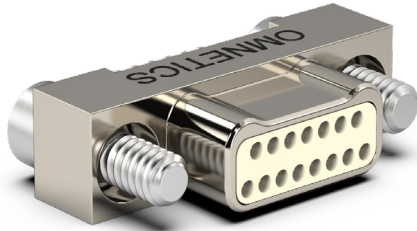

**SUGGESTED PAD LAYOUT
(VIEW FROM MOUNTING SIDE OF BOARD)**

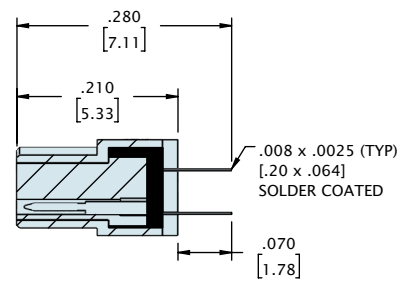
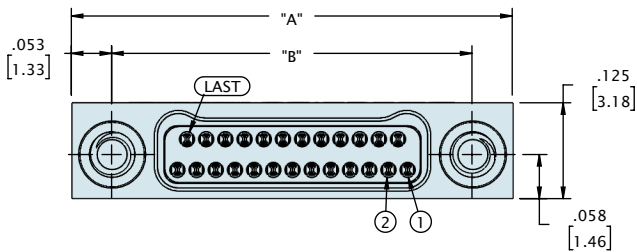

JACKSCREW NOT SHOWN FOR CLARITY

CONTACTS	"A"	"B"	"C"	"D"	"E"	"F"
09	.375 [9.53]	.270 [6.86]	.160 [4.06]	.170 [4.32]	.100 [2.54]	.075 [1.91]
15	.450 [11.43]	.345 [8.76]	.235 [5.97]	.245 [6.22]	.175 [4.45]	.150 [3.81]
21	.525 [13.34]	.420 [10.67]	.310 [7.87]	.320 [8.13]	.250 [6.35]	.225 [5.72]
25	.575 [14.61]	.470 [11.94]	.360 [9.14]	.370 [9.40]	.300 [7.62]	.275 [6.99]
31	.650 [16.51]	.545 [13.84]	.435 [11.05]	.445 [11.30]	.375 [9.53]	.350 [8.89]
37	.725 [18.42]	.620 [15.75]	.510 [12.95]	.520 [13.21]	.450 [11.43]	.425 [10.80]
51	.900 [22.86]	.795 [20.19]	.685 [17.40]	.695 [17.65]	.625 [15.88]	.600 [15.24]
65	1.075 [27.31]	.970 [24.64]	.860 [21.84]	.870 [22.10]	.800 [20.32]	.775 [19.69]
85	1.325 [33.66]	1.220 [30.99]	1.110 [28.19]	1.120 [28.45]	1.050 [26.67]	1.025 [26.04]

DIMENSIONS IN [] ARE IN MILLIMETERS AND ARE FOR REFERENCE ONLY

DUAL ROW STRAIGHT TAIL (TYPE DD)

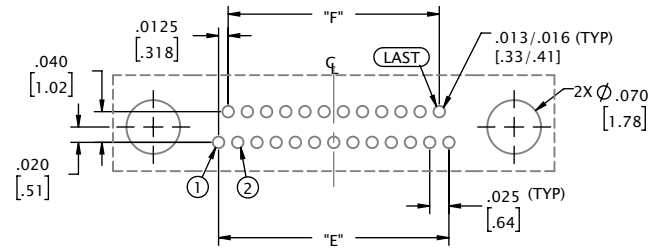
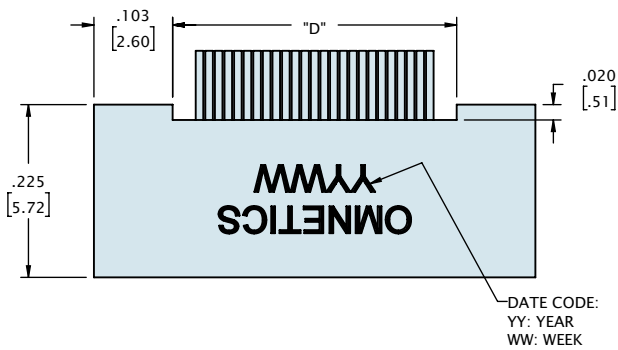
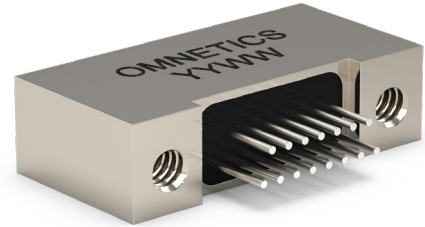

SUGGESTED PAD LAYOUT
(VIEW FROM MOUNTING SIDE OF BOARD)

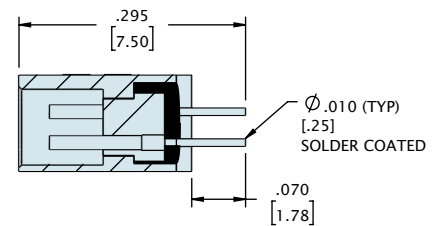
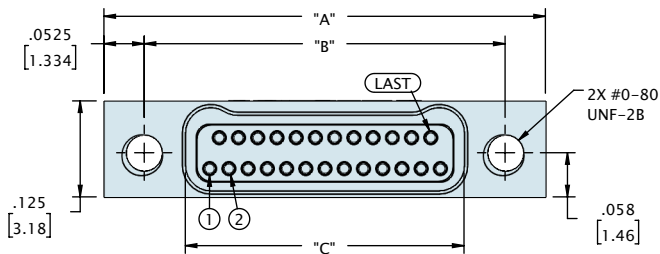

CONTACTS	"A"	"B"	"C"	"D"	"E"	"F"
09	.375 [9.53]	.270 [6.86]	.163 [4.14]	.170 [4.32]	.100 [2.54]	.075 [1.91]
15	.450 [11.43]	.345 [8.76]	.238 [6.05]	.245 [6.22]	.175 [4.45]	.150 [3.81]
21	.525 [13.34]	.420 [10.67]	.313 [7.95]	.320 [8.13]	.250 [6.35]	.225 [5.72]
25	.575 [14.61]	.470 [11.94]	.363 [9.22]	.370 [9.40]	.300 [7.62]	.275 [6.99]
31	.650 [16.51]	.545 [13.84]	.438 [11.13]	.445 [11.30]	.375 [9.53]	.350 [8.89]
37	.725 [18.42]	.620 [15.75]	.513 [13.03]	.520 [13.21]	.450 [11.43]	.425 [10.80]
51	.900 [22.86]	.795 [20.19]	.688 [17.48]	.695 [17.65]	.625 [15.88]	.600 [15.24]
65	1.075 [27.31]	.970 [24.64]	.863 [21.92]	.870 [22.10]	.800 [20.32]	.775 [19.69]
85	1.325 [33.66]	1.220 [30.99]	1.113 [28.27]	1.120 [28.45]	1.050 [26.67]	1.025 [26.04]

DIMENSIONS IN [] ARE IN MILLIMETERS AND ARE FOR REFERENCE ONLY

ORDERING GUIDE

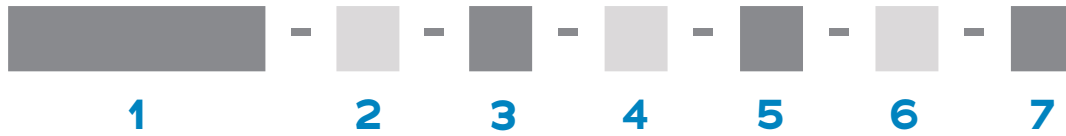

1 Series	MNPO Metal Nano Pin Offset	MNSO Metal Nano Socket Offset
2 Number Of Contacts	O9 15 21 25 31 37 51 65 85	
3 Termination Type	DD Thru-Hole Straight	
4 Shell Material & Finish	N Aluminium Shell, Electroless Nickel Plated B Aluminium Shell, Black Anodized T Titanium Shell, Unplated	CD Aluminium shell, Cadmium Plated S Stainless Steel Shell, Passivated
5 Common Options	ETH End Threaded Hole, #0-80 NTH Non-Threaded Holes For Mounting To The Board YY Non Standard Hardware (threaded holes, thumb screws, #2-56 screw) HT High Temp. Epoxy CS Customer Supplied Material	
6 Mod Codes	M10 Custom Keying M53 Space Grade Nano-D, SPT2	M50 Space Grade Nano-D, SPT1
7 Special Instructions	YYY Describe anything that is not covered in standard options	

DUAL ROW HORIZONTAL THRU-HOLE (TYPE H4)

The Dual Row Bi-Lobe[®] H4 nanos are suitable for high-reliability miniature applications that must deliver exceptional performance in medical, military, and other demanding environments. They are a thru-hole mounted, low-mass ruggedized connector on .025" (.64) centerlines. The thru-hole tails are spread onto a mounting pattern on .050 (1.27 mm) with space for annular rings and routing traces. They feature Omnetics' gold-plated Flex Pin contact system. These durable, lightweight connectors provide power and signal under rigorous conditions and intermate with Omnetics QPL versions of MIL-DTL-32139. They are available with retention screws for a positive lock and come in standard sizes ranging from 9 to 65 positions. Custom configurations are also available.



Electro-Mechanical Specifications

TYPE	PERFORMANCE
Durability	> 2000 Mating Cycles min
Temperature	-55°C to +125 °C (200 °C w/HTE)
Current rating	1 Amp per contact
Voltage Rating (DWV)	250 VAC RMS Sea Level
Insulation Resistance	5,000 Megohms @ 100 VDC
Shock	100 g's discontinuity < 10 nanoseconds
Vibration	20 g's discontinuity < 10 nanoseconds
Thermal Vacuum Outgassing	1.0% max TML, 0.1% VCM
Contact Resistance	87 milliohms (87 mV) max @ 1 Amp
Mating/Unmating Force	2.5 oz. (.71g) typical per contact

Material Specifications

TYPE	PERFORMANCE
Contact	Copper Alloy Per MIL-DTL-32139
Contact Finish	Gold per ASTM B488, Type II, Class 1.27, Code C Over Nickel Underplate
Insulator	LCP Per MIL-DTL-32139 Or PEEK
Encapsulant	Epoxy

Shell Options

TYPE	PERFORMANCE
Aluminum 6061	Electroless Nickel per SAE-AMS-2404
Stainless Steel, 300 Series	Passivated per SAE-AMS-2700

DUAL ROW HORIZONTAL THRU-HOLE (TYPE H4)

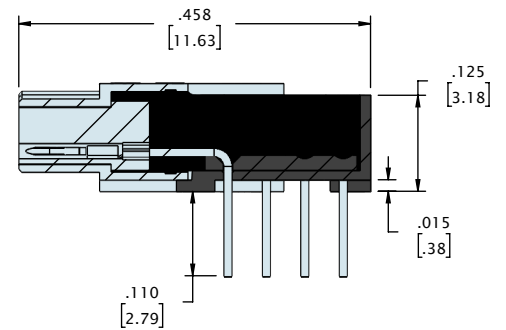
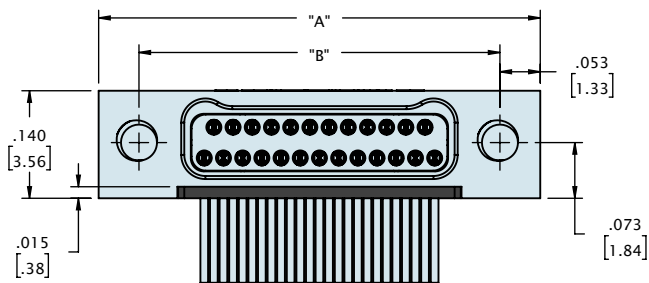
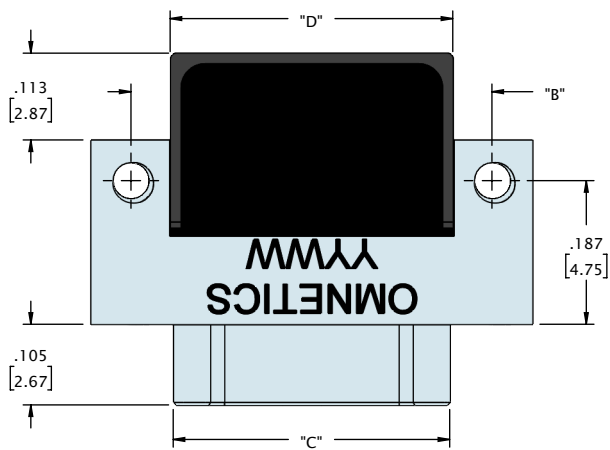
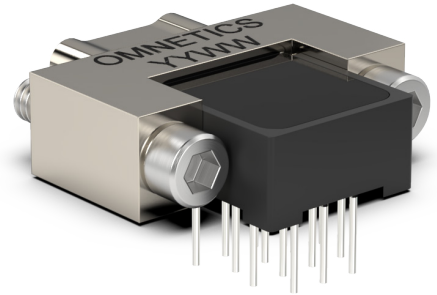
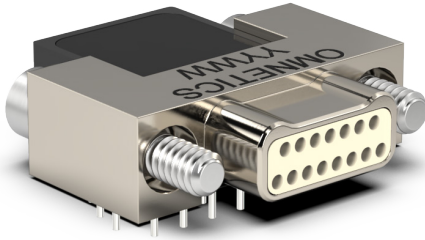

CONTACTS	"A"	"B"	"C"	"D"
09	.375 [9.53]	.270 [6.86]	.160 [4.06]	.168 [4.27]
15	.450 [11.43]	.345 [8.76]	.235 [5.97]	.243 [6.17]
21	.525 [13.34]	.420 [10.67]	.310 [7.87]	.318 [8.08]
25	.575 [14.61]	.470 [11.94]	.360 [9.14]	.368 [9.35]
31	.650 [16.51]	.545 [13.84]	.435 [11.05]	.443 [11.25]
37	.725 [18.42]	.620 [15.75]	.510 [12.95]	.518 [13.16]
51	.900 [22.86]	.795 [20.19]	.685 [17.40]	.693 [17.60]
65	1.075 [27.31]	.970 [24.64]	.860 [21.84]	.868 [22.05]
85	1.325 [33.66]	1.220 [30.99]	1.110 [28.19]	1.118 [28.40]

DIMENSIONS IN [] ARE IN MILLIMETERS AND ARE FOR REFERENCE ONLY

DUAL ROW HORIZONTAL THRU-HOLE (TYPE H4)

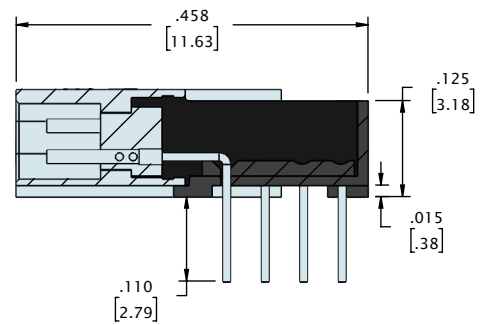
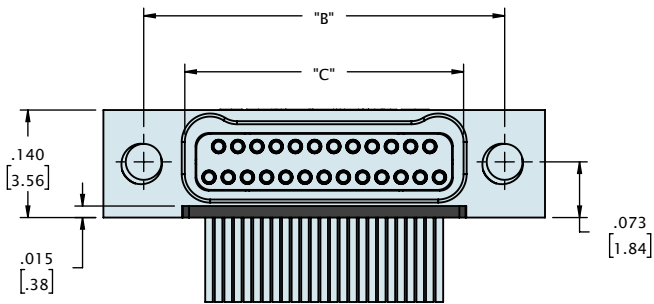
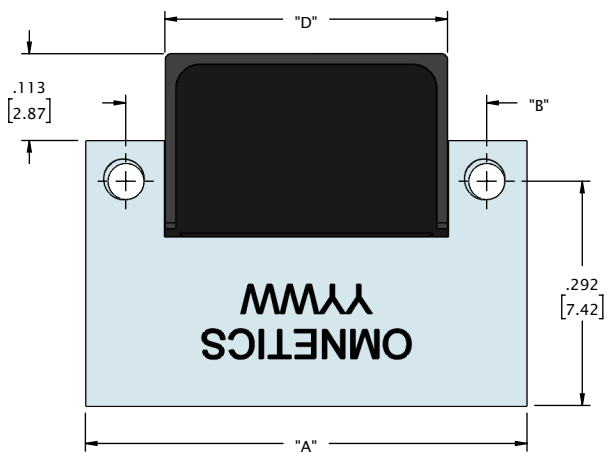
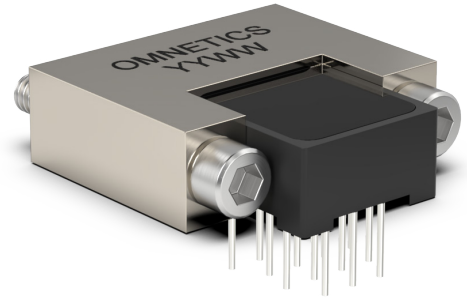
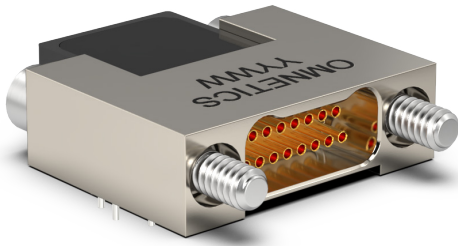

CONTACTS	"A"	"B"	"C"	"D"
09	.375 [9.53]	.270 [6.86]	.163 [4.14]	.168 [4.27]
15	.450 [11.43]	.345 [8.76]	.238 [6.05]	.243 [6.17]
21	.525 [13.34]	.420 [10.67]	.313 [7.95]	.318 [8.08]
25	.575 [14.61]	.470 [11.94]	.363 [9.22]	.368 [9.35]
31	.650 [16.51]	.545 [13.84]	.438 [11.13]	.443 [11.25]
37	.725 [18.42]	.620 [15.75]	.513 [13.03]	.518 [13.16]
51	.900 [22.86]	.795 [20.19]	.688 [17.48]	.693 [17.60]
65	1.075 [27.31]	.970 [24.64]	.863 [21.92]	.868 [22.05]
85	1.325 [33.66]	1.220 [30.99]	1.113 [28.27]	1.118 [28.40]

DIMENSIONS IN [] ARE IN MILLIMETERS AND ARE FOR REFERENCE ONLY

DUAL ROW HORIZONTAL THRU-HOLE (TYPE H4)

9 CONTACT PLUG

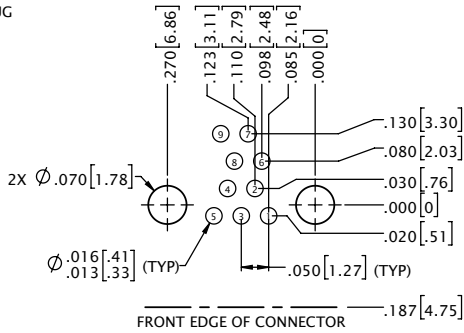

15 CONTACT PLUG

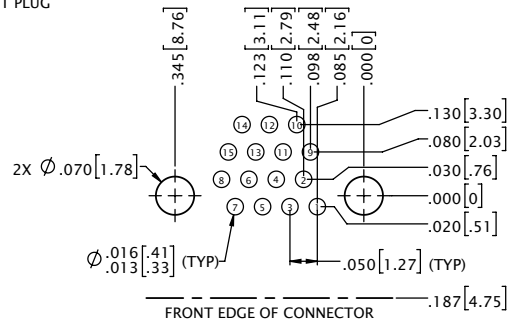

21 CONTACT PLUG

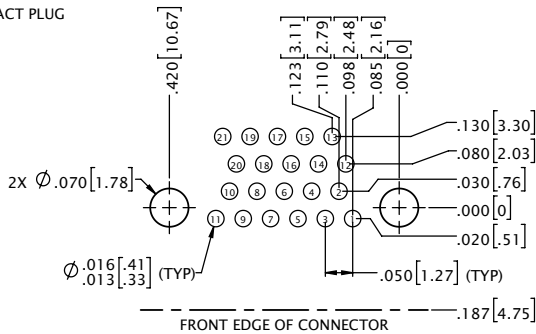

25 CONTACT PLUG

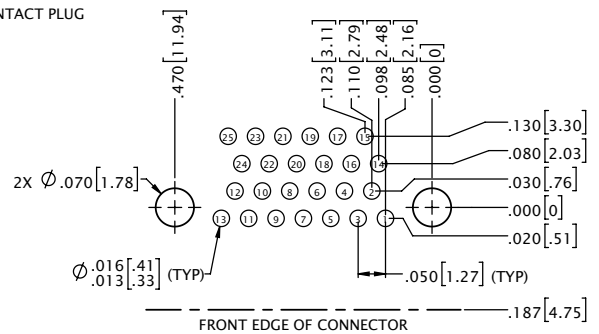

31 CONTACT PLUG

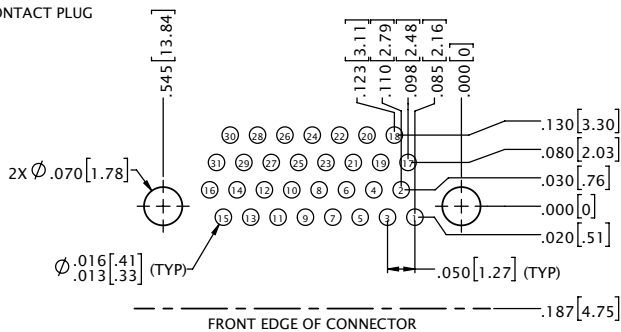

37 CONTACT PLUG

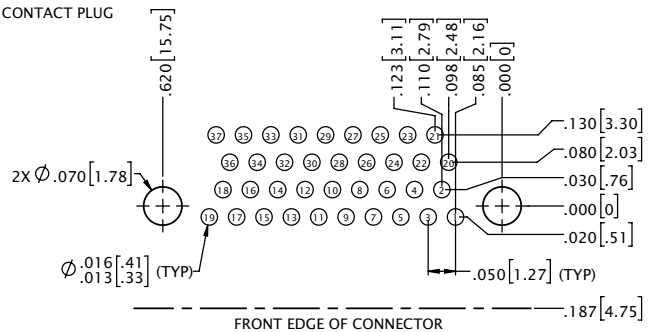

51 CONTACT PLUG

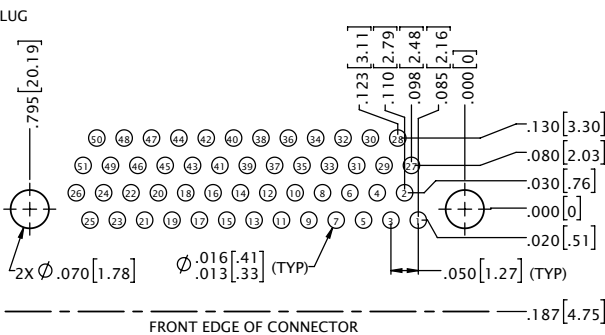

65 CONTACT PLUG

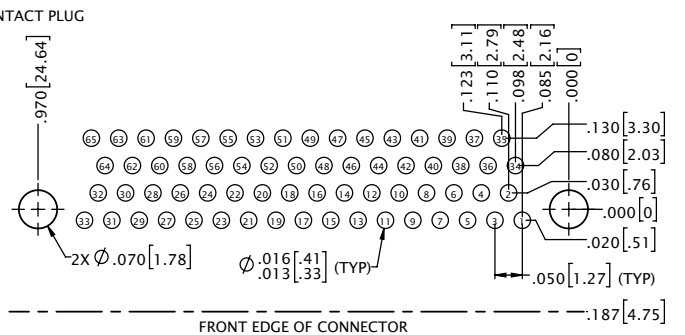

DUAL ROW HORIZONTAL THRU-HOLE (TYPE H4)

9 CONTACT SOCKET

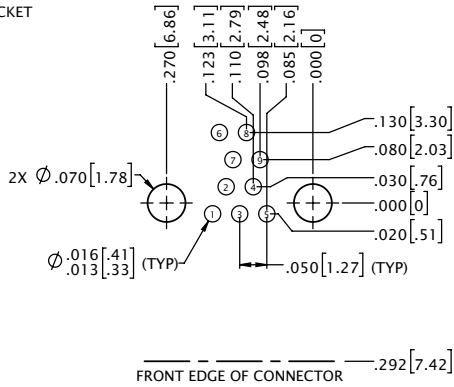

15 CONTACT SOCKET

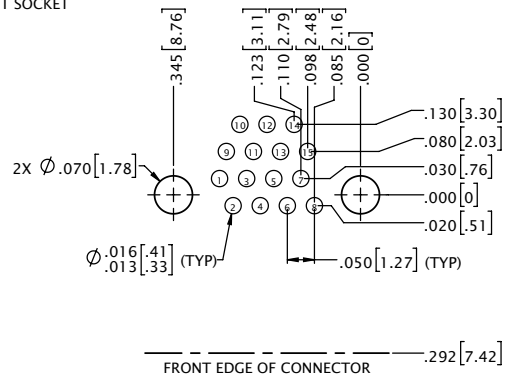

21 CONTACT SOCKET

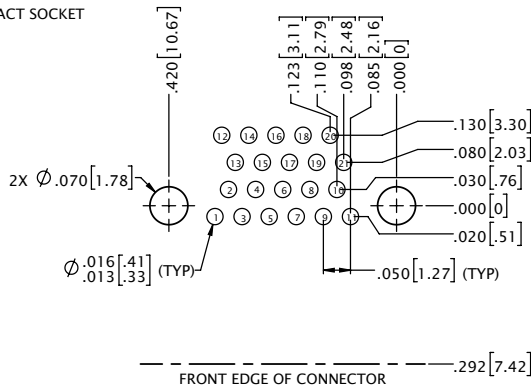

25 CONTACT SOCKET

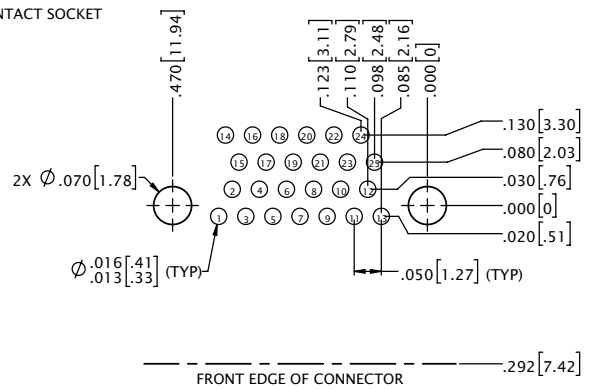

31 CONTACT SOCKET

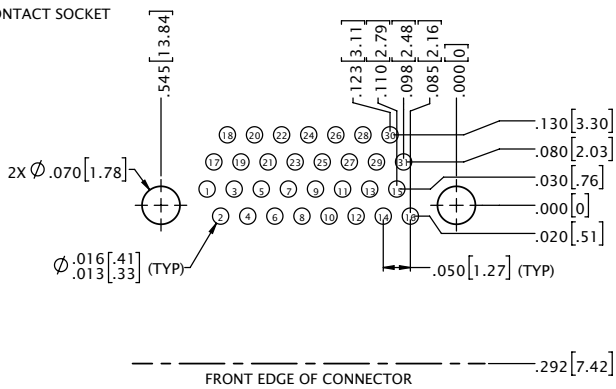

37 CONTACT SOCKET

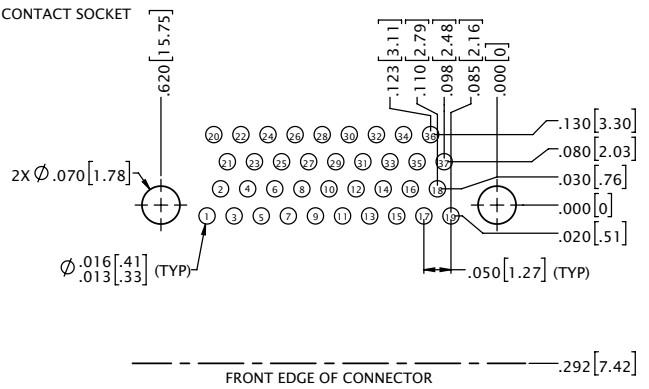

51 CONTACT SOCKET

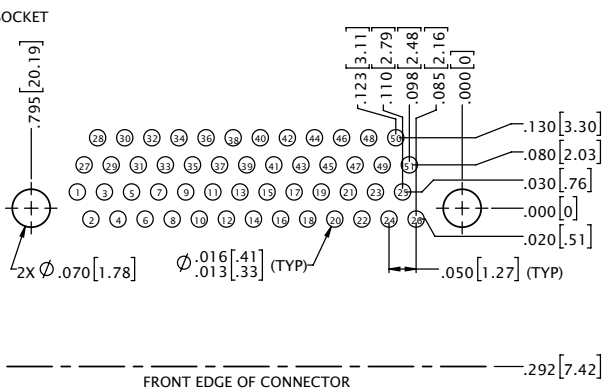

65 CONTACT SOCKET

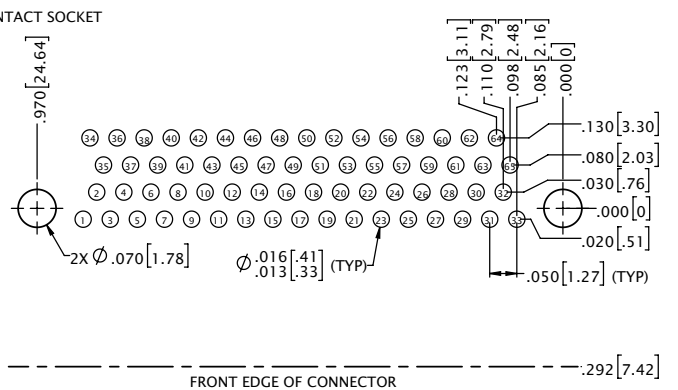

ORDERING GUIDE

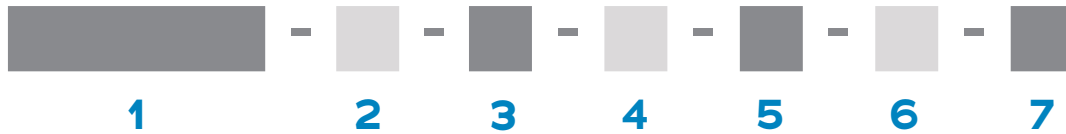

1 Series	MNPO Metal Nano Pin Offset	MNSO Metal Nano Socket Offset							
2 Number Of Contacts	O9	15	21	25	31	37	51	65	85
3 Termination Type	H4 Horizontal Thru-Hole								
4 Shell Material & Finish	N Aluminum Shell, Electroless Nickel Plated			CD Aluminium shell, Cadmium Plated					
	B Aluminium Shell, Black Anodized			S Stainless Steel Shell, Passivated					
	T Titanium Shell, Unplated								
5 Common Options	ETH End Threaded Hole, #0-80			EJS End Jack Screw					
	NTH Non-Threaded Holes For Mounting To The Board								
	YY Non Standard Hardware (threaded holes, thumb screws, #2-56 screw)								
	HT High Temp. Epoxy			RH RoHS Compliant					
	CS Customer Supplied Material								
6 Mod Codes	M10 Custom Keying			M50 Space Grade Nano-D, SPT1					
	M53 Space Grade Nano-D, SPT2								
7 Special Instructions	YYY Describe anything that is not covered in standard options								

DUAL ROW VERTICAL THRU-HOLE (TYPE V4)

Applications that experience frequent high vibration and shock are served well by Omnetics' **Dual Row Bi-Lobe® V4** nanos. This low-mass vertical thru-hole mounted connector has contacts arranged on .025" (.64 mm) centerlines. The thru-hole tails are spread onto a mounting pattern on .050 (1.27 mm) with space for annular rings and routing traces. They feature Omnetics' gold-plated Flex Pin contact system. These durable, lightweight connectors serve the most demanding applications and intermate with Omnetics QPL versions of MIL-DTL-32139. They are available with retention screws for a positive lock and come in standard sizes ranging from 9 to 65 positions. Custom configurations are also available.

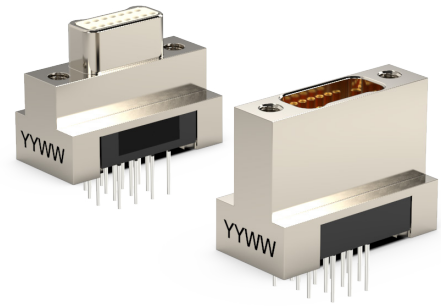

Electro-Mechanical Specifications

TYPE	PERFORMANCE
Durability	> 2000 Mating Cycles min
Temperature	-55°C to +125 °C (200 °C w/HTE)
Current rating	1 Amp per contact
Voltage Rating (DWV)	250 VAC RMS Sea Level
Insulation Resistance	5,000 Megohms @ 100 VDC
Shock	100 g's discontinuity < 10 nanoseconds
Vibration	20 g's discontinuity < 10 nanoseconds
Thermal Vacuum Outgassing	1.0% max TML, 0.1% VCM
Contact Resistance	87 milliohms (87 mV) max @ 1 Amp
Mating/Unmating Force	2.5 oz. (.71g) typical per contact

Material Specifications

TYPE	PERFORMANCE
Contact	Copper Alloy Per MIL-DTL-32139
Contact Finish	Gold per ASTM B488, Type II, Class 1.27, Code C Over Nickel Underplate
Insulator	LCP Per MIL-DTL-32139 Or PEEK
Encapsulant	Epoxy

Shell Options

TYPE	PERFORMANCE
Aluminum 6061	Electroless Nickel per SAE-AMS-2404
Stainless Steel, 300 Series	Passivated per SAE-AMS-2700

DUAL ROW VERTICAL THRU-HOLE (TYPE V4)

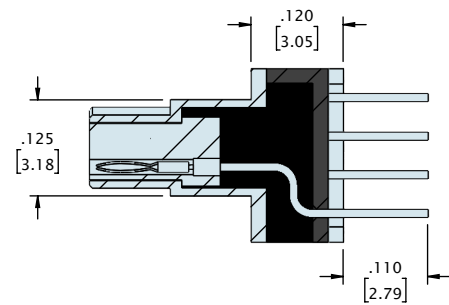
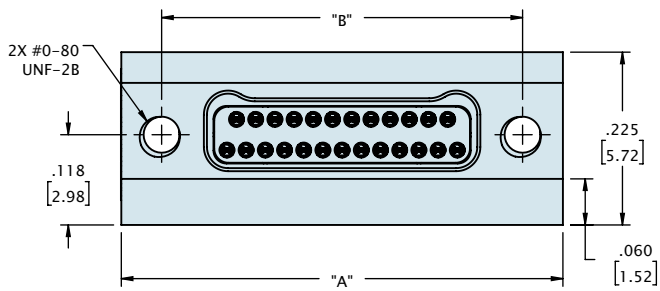
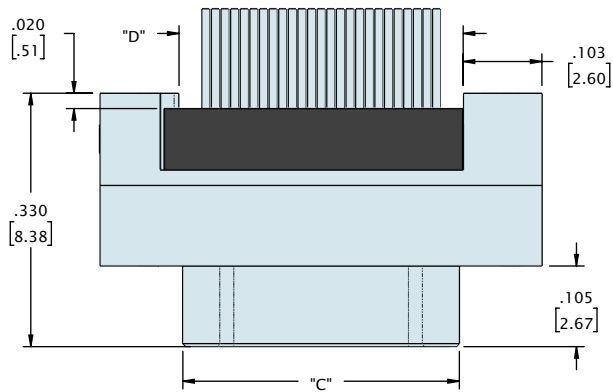
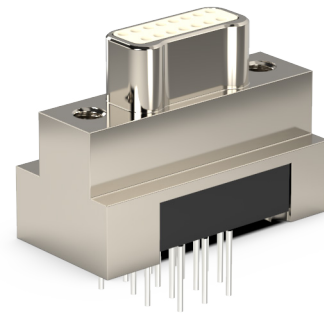
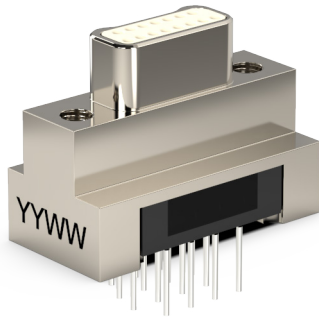

CONTACTS	"A"	"B"	"C"	"D"
09	.375 [9.53]	.270 [6.86]	.160 [4.06]	.170 [4.32]
15	.450 [11.43]	.345 [8.76]	.235 [5.97]	.245 [6.22]
21	.525 [13.34]	.420 [10.67]	.310 [7.87]	.320 [8.13]
25	.575 [14.61]	.470 [11.94]	.360 [9.14]	.370 [9.40]
31	.650 [16.51]	.545 [13.84]	.435 [11.05]	.445 [11.30]
37	.725 [18.42]	.620 [15.75]	.510 [12.95]	.520 [13.21]
51	.900 [22.86]	.795 [20.19]	.685 [17.40]	.695 [17.65]
65	1.075 [27.31]	.970 [24.64]	.860 [21.84]	.870 [22.10]
85	1.325 [33.66]	1.220 [30.99]	1.110 [28.19]	1.120 [28.45]

DIMENSIONS IN [] ARE IN MILLIMETERS AND ARE FOR REFERENCE ONLY

DUAL ROW VERTICAL THRU-HOLE (TYPE V4)

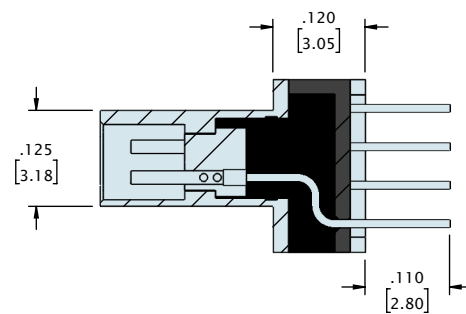
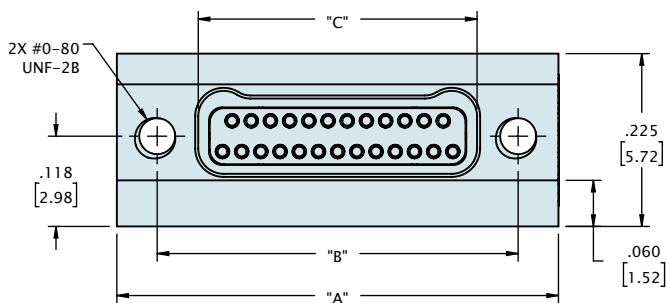
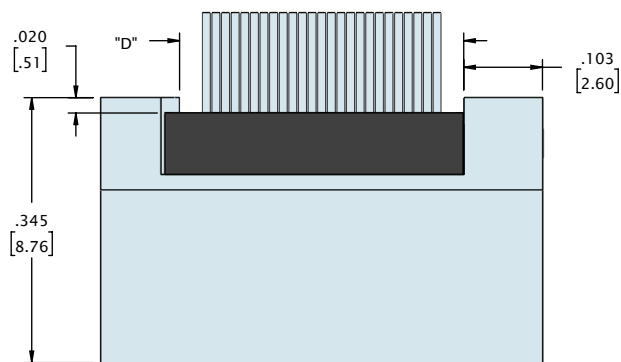
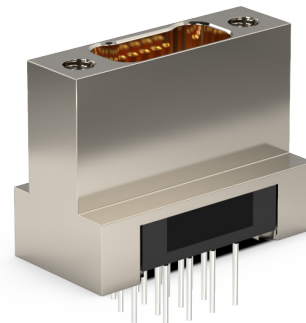
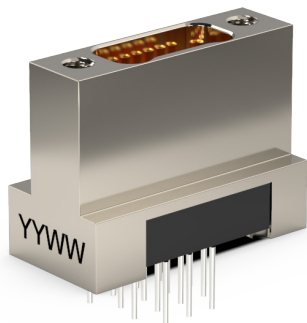

CONTACTS	"A"	"B"	"C"	"D"
09	.375 [9.53]	.270 [6.86]	.163 [4.14]	.170 [4.32]
15	.450 [11.43]	.345 [8.76]	.238 [6.05]	.245 [6.22]
21	.525 [13.34]	.420 [10.67]	.313 [7.95]	.320 [8.13]
25	.575 [14.61]	.470 [11.94]	.363 [9.22]	.370 [9.40]
31	.650 [16.51]	.545 [13.84]	.438 [11.13]	.445 [11.30]
37	.725 [18.42]	.620 [15.75]	.513 [13.03]	.520 [13.21]
51	.900 [22.86]	.795 [20.19]	.688 [17.48]	.695 [17.65]
65	1.075 [27.31]	.970 [24.64]	.863 [21.92]	.870 [22.10]
85	1.325 [33.66]	1.220 [30.99]	1.113 [28.27]	1.120 [28.45]

DIMENSIONS IN [] ARE IN MILLIMETERS AND ARE FOR REFERENCE ONLY

DUAL ROW VERTICAL THRU-HOLE (TYPE V4)

9 CONTACT PLUG

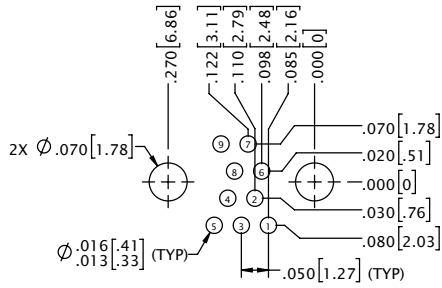

15 CONTACT PLUG

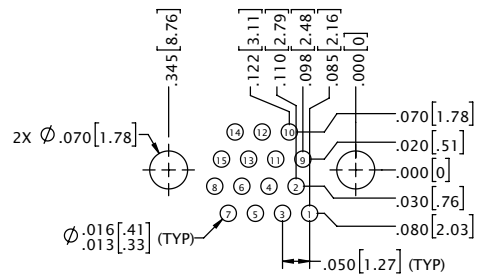

21 CONTACT PLUG

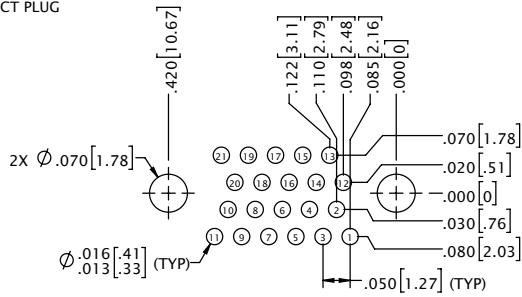

25 CONTACT PLUG

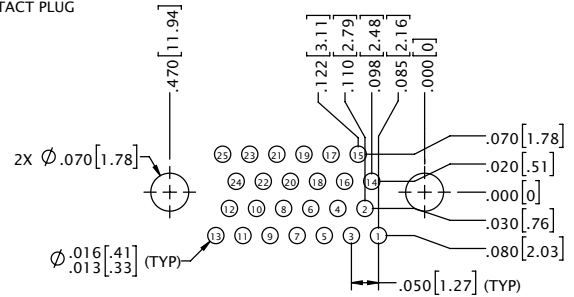

31 CONTACT PLUG

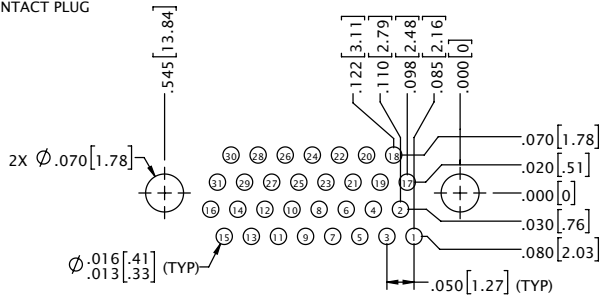

37 CONTACT PLUG

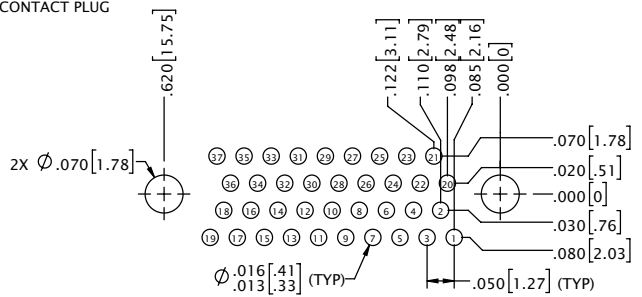

51 CONTACT PLUG

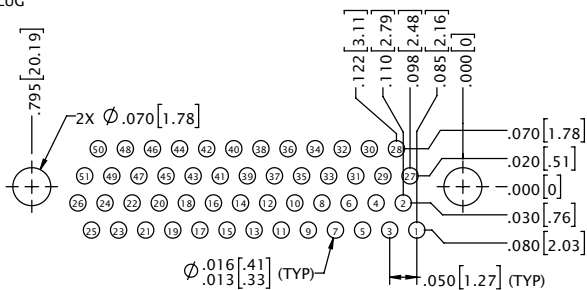

65 CONTACT PLUG

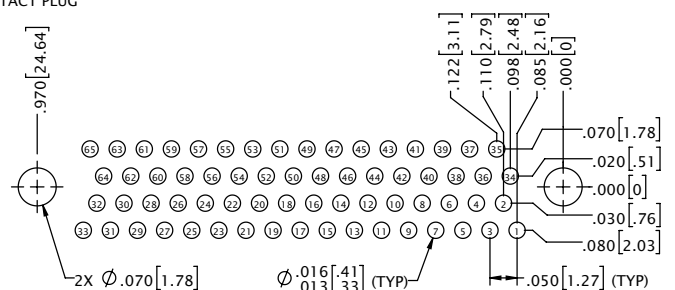

85 CONTACT PLUG

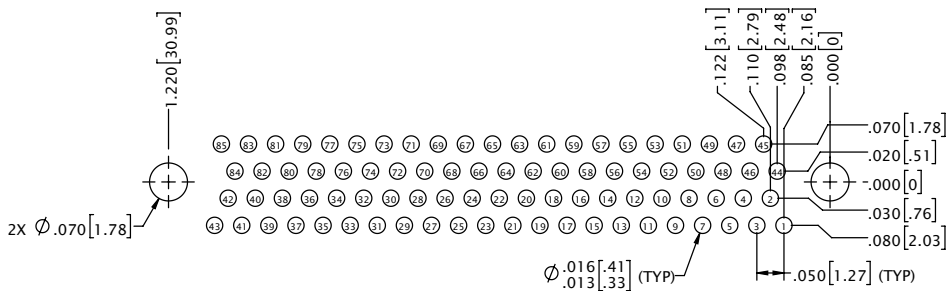

DUAL ROW VERTICAL THRU-HOLE (TYPE V4)

9 CONTACT SOCKET

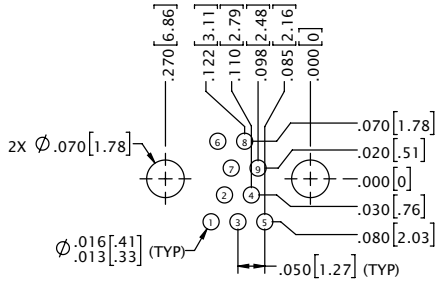

15 CONTACT SOCKET

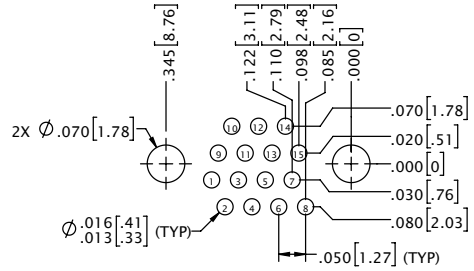

21 CONTACT SOCKET

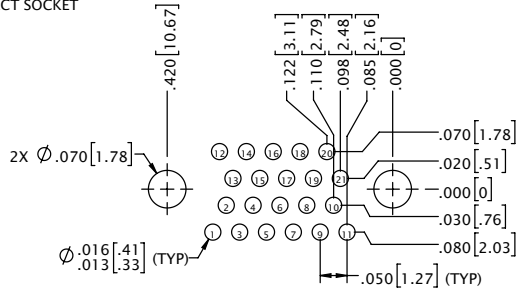

25 CONTACT SOCKET

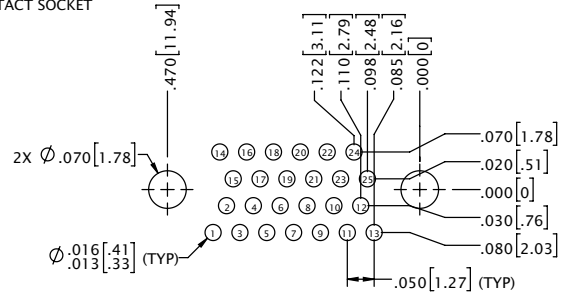

31 CONTACT SOCKET

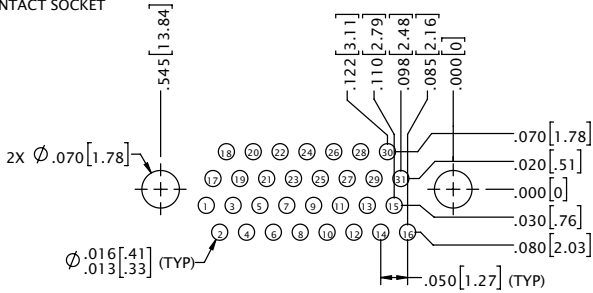

37 CONTACT SOCKET

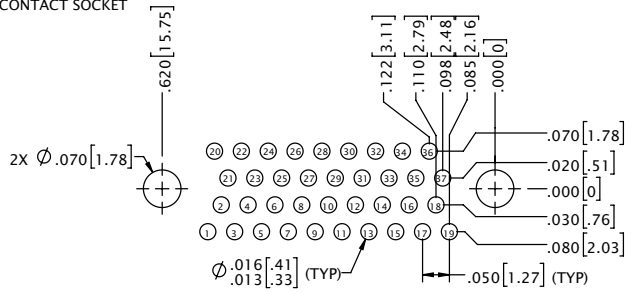

51 CONTACT SOCKET

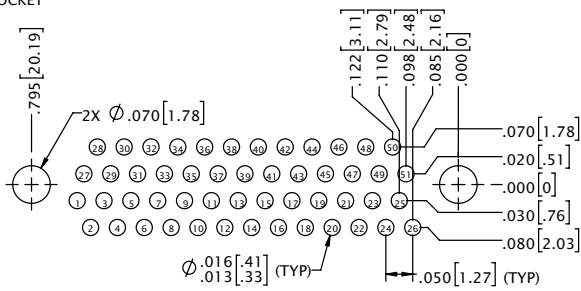

65 CONTACT SOCKET

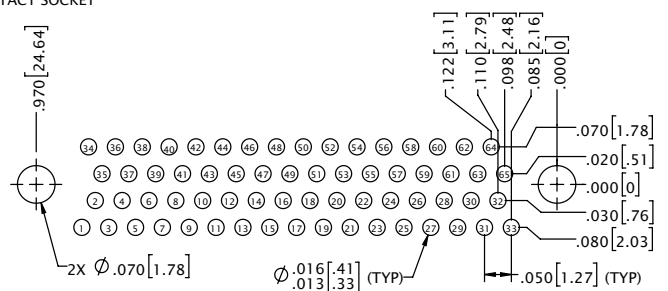

85 CONTACT SOCKET

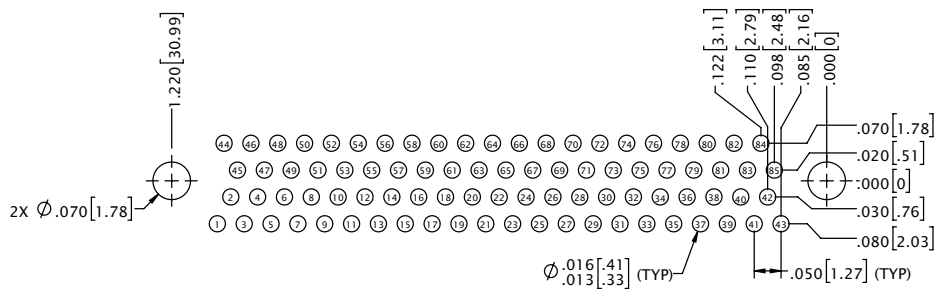

ORDERING GUIDE

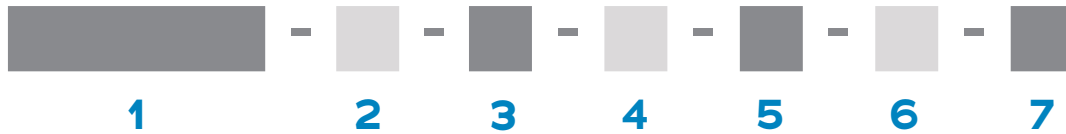

1 Series	MNPO Metal Nano Pin Offset	MNSO Metal Nano Socket Offset
2 Number Of Contacts	09 15 21 25 31 37 51 65 85	
3 Termination Type	V4 Vertical Thru-Hole	
4 Shell Material & Finish	N Aluminum Shell, Electroless Nickel Plated B Aluminium Shell, Black Anodized T Titanium Shell, Unplated	CD Aluminium shell, Cadmium Plated S Stainless Steel Shell, Passivated
5 Common Options	ETH End Threaded Hole, #0-80 NTH Non-Threaded Holes For Mounting To The Board YY Non Standard Hardware (threaded holes, thumb screws, #2-56 screw) HT High Temp. Epoxy CS Customer Supplied Material	
6 Mod Codes	M10 Custom Keying M53 Space Grade Nano-D, SPT2	M50 Space Grade Nano-D, SPT1
7 Special Instructions	YYY Describe anything that is not covered in standard options	

DUAL ROW FLEX TAIL (TYPE FF)

Flex Tail Bi-Lobe® nanos protect connectivity in critical applications with a low-profile, ruggedized design that serves well in high-reliability environments. The contacts are arranged on .025" (.64 mm) centerlines and the SMT tails are formed in an hourglass shape that allows a double-sided flex circuit to slide between the two rows. Spring tension holds the flex in place during the soldering process. They feature Omnetics' gold-plated Flex Pin contact system. These durable, lightweight connectors serve the most demanding applications and intermate with Omnetics QPL versions of MIL-DTL-32139. They are available with retention screws for a positive lock and come in standard sizes ranging from 9 to 85 positions. Custom configurations are also available.

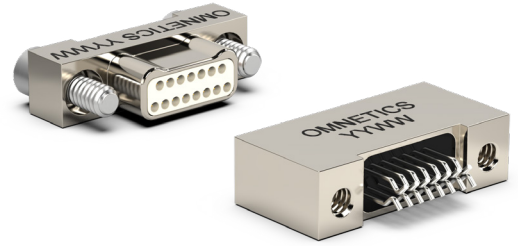

Electro-Mechanical Specifications

TYPE	PERFORMANCE
Durability	> 2000 Mating Cycles min
Temperature	-55°C to +125 °C (200 °C w/HTE)
Current rating	1 Amp per contact
Voltage Rating (DWV)	250 VAC RMS Sea Level
Insulation Resistance	5,000 Megohms @ 100 VDC
Shock	100 g's discontinuity < 10 nanoseconds
Vibration	20 g's discontinuity < 10 nanoseconds
Thermal Vacuum Outgassing	1.0% max TML, 0.1% VCM
Contact Resistance	71 milliohms (71 mV) max @ 1 Amp
Mating/Unmating Force	2.5 oz. (.71g) typical per contact

Material Specifications

TYPE	PERFORMANCE
Contact	Copper Alloy Per MIL-DTL-32139
Contact Finish	Gold per ASTM B488, Type II, Class 1.27, Code C Over Nickel Underplate
Insulator	LCP Per MIL-DTL-32139 Or PEEK
Encapsulant	Epoxy

Shell Options

TYPE	PERFORMANCE
Aluminum 6061	Electroless Nickel per SAE-AMS-2404
Stainless Steel, 300 Series	Passivated per SAE-AMS-2700

DUAL ROW FLEX TAIL (TYPE FF)

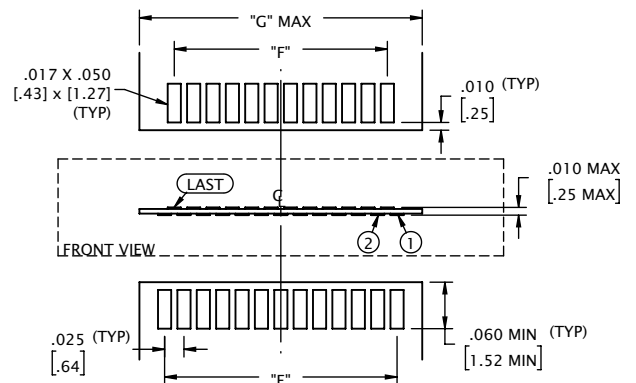
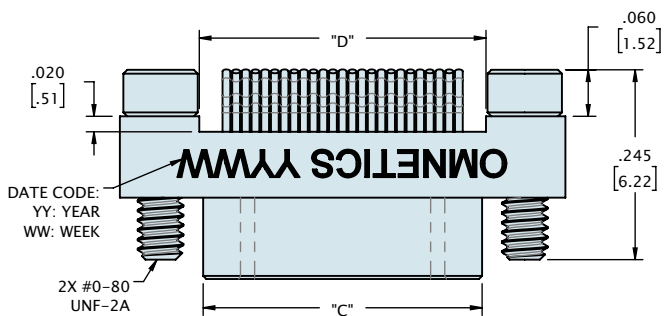
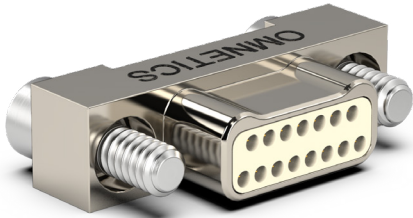

SUGGESTED PAD LAYOUT

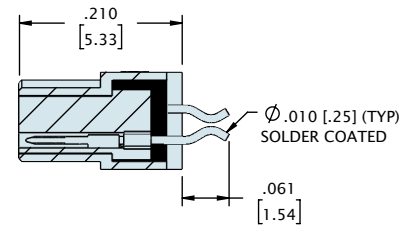
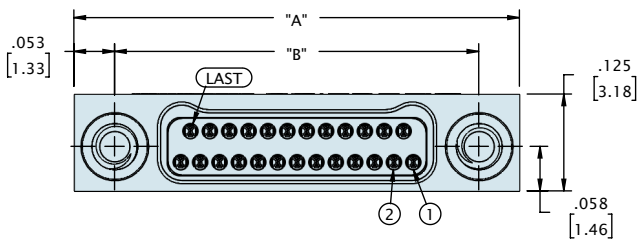

JACKSCREW NOT SHOWN FOR CLARITY

CONTACTS	"A"	"B"	"C"	"D"	"E"	"F"	"G"
09	.375 [9.53]	.270 [6.86]	.160 [4.06]	.170 [4.32]	.100 [2.54]	.075 [1.90]	.165 [4.19]
15	.450 [11.43]	.345 [8.76]	.235 [5.97]	.245 [6.22]	.175 [4.45]	.150 [3.81]	.240 [6.10]
21	.525 [13.34]	.420 [10.67]	.310 [7.87]	.320 [8.13]	.250 [6.35]	.225 [5.71]	.315 [8.00]
25	.575 [14.61]	.470 [11.94]	.360 [9.14]	.370 [9.40]	.300 [7.62]	.275 [6.98]	.365 [9.27]
31	.650 [16.51]	.545 [13.84]	.435 [11.05]	.445 [11.30]	.375 [9.52]	.350 [8.89]	.440 [11.18]
37	.725 [18.42]	.620 [15.75]	.510 [12.95]	.520 [13.21]	.450 [11.43]	.425 [10.79]	.515 [13.08]
51	.900 [22.86]	.795 [20.19]	.685 [17.40]	.695 [17.65]	.625 [15.87]	.600 [15.24]	.690 [17.53]
65	1.075 [27.31]	.970 [24.64]	.860 [21.84]	.870 [22.10]	.800 [20.32]	.775 [19.68]	.865 [21.97]
69	1.125 [28.58]	1.020 [25.91]	.910 [23.11]	.920 [23.37]	.850 [21.59]	.825 [20.96]	.915 [23.24]
85	1.325 [33.66]	1.220 [30.99]	1.110 [28.19]	1.120 [28.45]	1.050 [26.67]	1.025 [26.03]	1.115 [28.32]

DIMENSIONS IN [] ARE IN MILLIMETERS AND ARE FOR REFERENCE ONLY

DUAL ROW FLEX TAIL (TYPE FF)

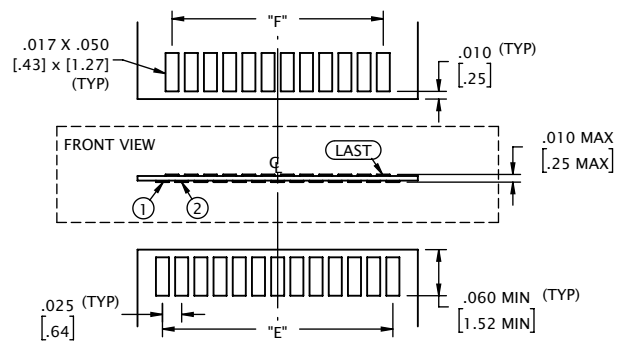
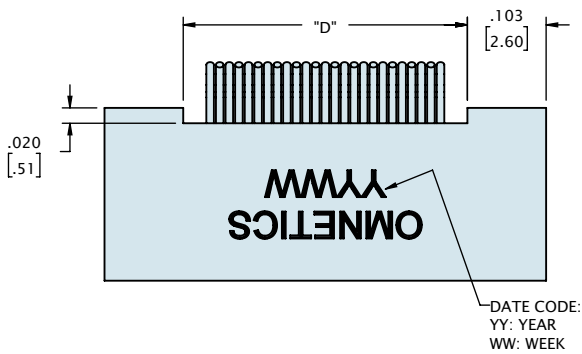
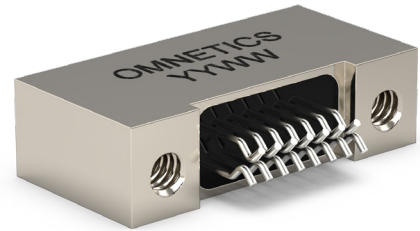

SUGGESTED PAD LAYOUT

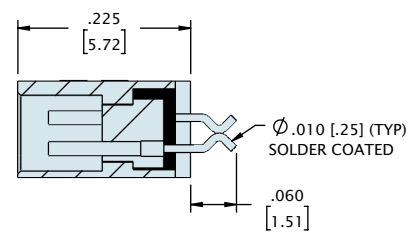
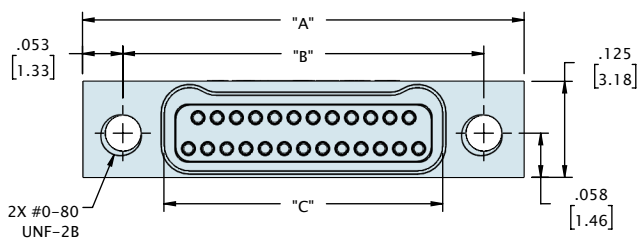

CONTACTS	"A"	"B"	"C"	"D"	"E"	"F"
09	.375 [9.53]	.270 [6.86]	.163 [4.14]	.170 [4.32]	.100 [2.54]	.075 [1.91]
15	.450 [11.43]	.345 [8.76]	.238 [6.05]	.245 [6.22]	.175 [4.45]	.150 [3.81]
21	.525 [13.34]	.420 [10.67]	.313 [7.95]	.320 [8.13]	.250 [6.35]	.225 [5.72]
25	.575 [14.61]	.470 [11.94]	.363 [9.22]	.370 [9.40]	.300 [7.62]	.275 [6.99]
31	.650 [16.51]	.545 [13.84]	.438 [11.13]	.445 [11.30]	.375 [9.53]	.350 [8.89]
37	.725 [18.42]	.620 [15.75]	.513 [13.03]	.520 [13.21]	.450 [11.43]	.425 [10.80]
51	.900 [22.86]	.795 [20.19]	.688 [17.48]	.695 [17.65]	.625 [15.88]	.600 [15.24]
65	1.075 [27.31]	.970 [24.64]	.863 [21.92]	.870 [22.10]	.800 [20.32]	.775 [19.69]
85	1.325 [33.66]	1.220 [30.99]	1.113 [28.27]	1.120 [28.45]	1.050 [26.67]	1.025 [26.04]

DIMENSIONS IN [] ARE IN MILLIMETERS AND ARE FOR REFERENCE ONLY

ORDERING GUIDE

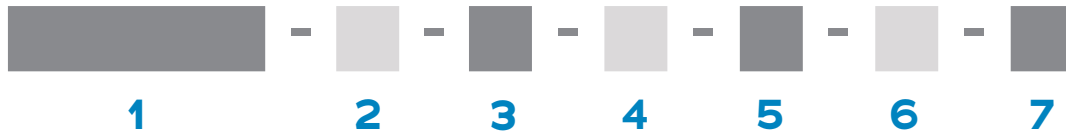

1 Series	MNPO Metal Nano Pin Offset	MNSO Metal Nano Socket Offset
2 Number Of Contacts	O9 15 21 25 31 37 51 65 69 85	
3 Termination Type	FF Flex Tail	
4 Shell Material & Finish	N Aluminium Shell, Electroless Nickel Plated B Aluminium Shell, Black Anodized T Titanium Shell, Unplated	CD Aluminium shell, Cadmium Plated S Stainless Steel Shell, Passivated
5 Common Options	ETH End Threaded Hole, #0-80 NTH Non-Threaded Holes For Mounting To The Board YY Non Standard Hardware (threaded holes, thumb screws, #2-56 screw) HT High Temp. Epoxy CS Customer Supplied Material	
6 Mod Codes	M10 Custom Keying M53 Space Grade Nano-D, SPT2	M50 Space Grade Nano-D, SPT1
7 Special Instructions	YYY Describe anything that is not covered in standard options	

DUAL ROW PRE-WIRED (TYPE WD)

Pre-Wired Dual Row Bi-Lobe[®] nanos feature 30 AWG or smaller sizes of stranded wire. Omnetics assembles them using our proprietary semi-automated crimping system, as their very small size requires special care and precision to accomplish a perfect crimp. Each unit is carefully hand-inspected throughout the assembly process. Pre-crimped wires and contacts are potted in place to further protect the integrity of the crimp joint. Designers may specify wire type, size, and color coding to achieve a near-custom part. COTS versions with 18" of color-coded AWG Teflon are also available for quick turnaround. These connectors come in standard sizes ranging from 9 to 91 positions, as well as custom configurations. Omnetics also offers full QPL versions of MIL-DTL-32139.

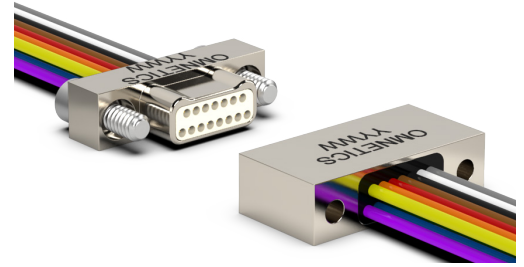

Electro-Mechanical Specifications

TYPE	PERFORMANCE
Durability	> 2000 Mating Cycles min
Temperature	-55°C to +125 °C (200 °C w/HTE)
Current rating	1 Amp per contact
Voltage Rating (DWV)	250 VAC RMS Sea Level
Insulation Resistance	5,000 Megohms @ 100 VDC
Shock	100 g's discontinuity < 10 nanoseconds
Vibration	20 g's discontinuity < 10 nanoseconds
Thermal Vacuum Outgassing	1.0% max TML, 0.1% VCM
Contact Resistance	71 milliohms (71 mV) max @ 1 Amp
Mating/Unmating Force	2.5 oz. (.71g) typical per contact

Material Specifications

TYPE	PERFORMANCE
Contact	Copper Alloy Per MIL-DTL-32139
Contact Finish	Gold per ASTM B488, Type II, Class 1.27, Code C Over Nickel Underplate
Insulator	LCP Per MIL-DTL-32139 Or PEEK
Encapsulant	Epoxy

Shell Options

TYPE	PERFORMANCE
Aluminum 6061	Electroless Nickel per SAE-AMS-2404
Stainless Steel, 300 Series	Passivated per SAE-AMS-2700

DUAL ROW PRE-WIRED (TYPE WD)

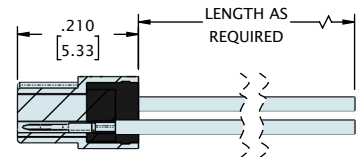
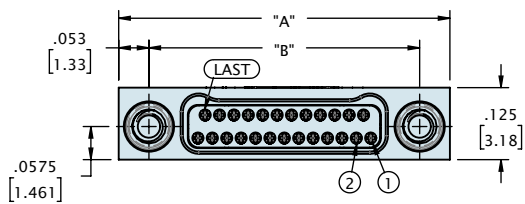
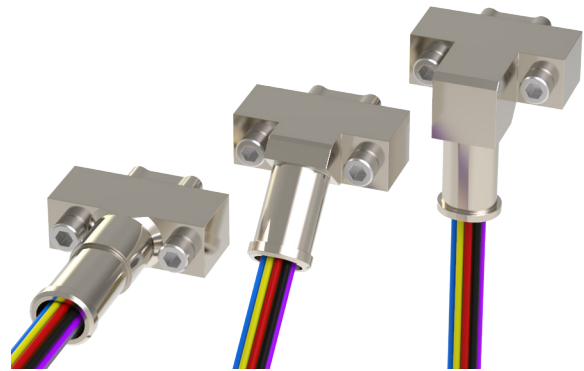
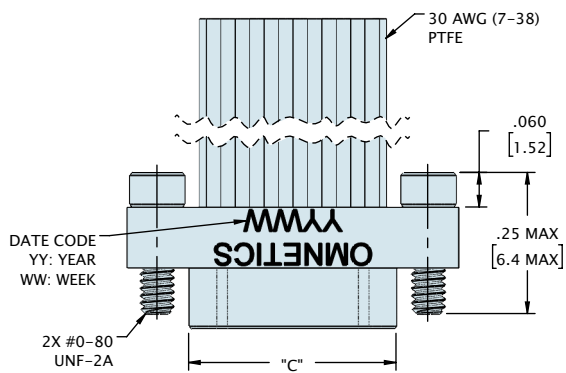
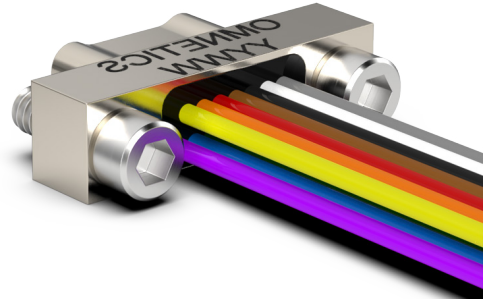
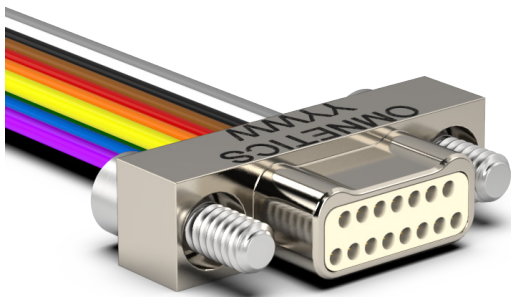

JACKSCREW HIDDEN FOR CLARITY

CONTACTS	"A"	"B"	"C"
09	.375 [9.53]	.270 [6.86]	.160 [4.06]
15	.450 [11.43]	.345 [8.76]	.235 [5.97]
21	.525 [13.34]	.420 [10.67]	.310 [7.87]
25	.575 [14.61]	.470 [11.94]	.360 [9.14]
31	.650 [16.51]	.545 [13.84]	.435 [11.05]
37	.725 [18.42]	.620 [15.75]	.510 [12.95]
51	.900 [22.86]	.795 [20.19]	.685 [17.40]
65	1.075 [27.31]	.970 [24.64]	.860 [21.84]
69	1.125 [28.58]	1.020 [25.91]	.910 [23.11]
85	1.325 [33.66]	1.220 [30.99]	1.110 [28.19]
91	1.452 [36.88]	1.321 [33.55]	1.185 [30.10]

DIMENSIONS IN [] ARE IN MILLIMETERS AND ARE FOR REFERENCE ONLY

DUAL ROW PRE-WIRED (TYPE WD)

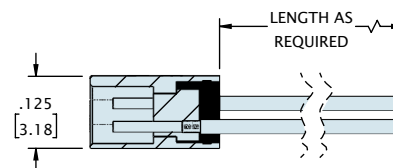
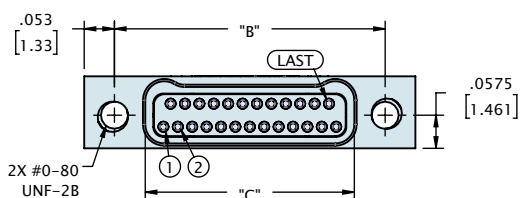
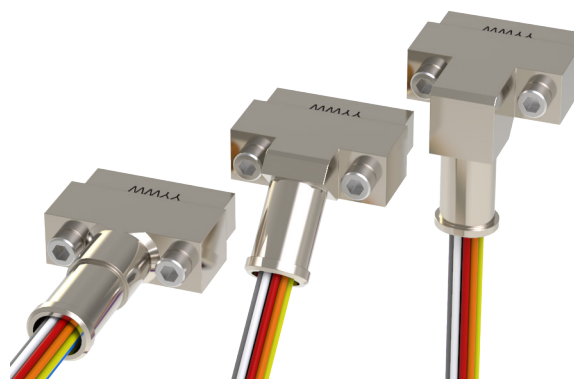
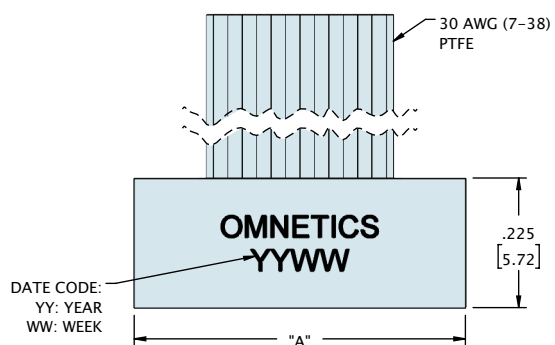
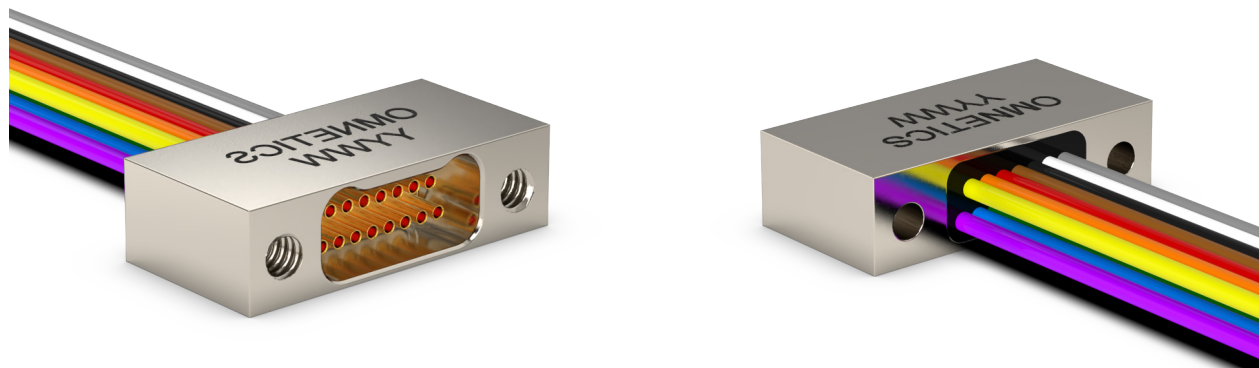

CONTACTS	"A"	"B"	"C"
09	.375 [9.53]	.270 [6.86]	.163 [4.14]
15	.450 [11.43]	.345 [8.75]	.238 [6.05]
21	.525 [13.34]	.420 [10.67]	.313 [7.95]
25	.575 [14.61]	.470 [11.94]	.363 [9.22]
31	.650 [16.51]	.545 [13.84]	.438 [11.13]
37	.725 [18.42]	.620 [15.75]	.513 [13.03]
51	.900 [22.86]	.795 [20.19]	.688 [17.48]
65	1.075 [27.31]	.970 [24.64]	.863 [21.92]
69	1.125 [28.58]	1.020 [25.91]	.913 [23.19]
85	1.325 [33.66]	1.220 [30.99]	1.113 [28.27]
91	1.452 [36.88]	1.321 [33.55]	1.188 [30.18]

DIMENSIONS IN [] ARE IN MILLIMETERS AND ARE FOR REFERENCE ONLY

ORDERING GUIDE



1 Series	MNPO Metal Nano Pin Offset	MNSO Metal Nano Socket Offset
2 Number Of Contacts	09 15 21 25 31 37 51	65 69 85 91
3 Termination Type	WD Discrete Wires	WC Cable
4 Wire Gage	0 30 AWG (STD)	2 32 AWG
5 Wire Type	Q NEMA HP3 (formerly M16878/4 and /6)	XX.X M22759/33 (30 AWG only)
6 Wire Length	18.0 18.00" (STD)	XX.X Custom Length
7 Color Scheme	C 10 Repeating Colors Per MIL STD 681	Y All Other Wire Color
8 Shell Material & Finish	N Aluminum Shell, Electroless Nickel Plated B Aluminium Shell, Black Anodized T Titanium Shell, Unplated	CD Aluminium shell, Cadmium Plated S Stainless steel Shell, Passivated
9 Common Options	ETH End Threaded Hole, #0-80 YY Non Standard Hardware (threaded holes, thumb screws, #2-56 screw) HT High Temp. Epoxy BS1 Standard Straight Backshell BS3 90/RA Oval BSY Custom Backshell	EJS End Jack Screw RH RoHS Compliant BS2 45 Oval BS4 2 Piece BS CS Customer Supplied Material
10 Shield / Jacket	D Slip-on Braid E Machine Braid F Flexo Braid J Nomex Braid ST Shrink Tube	
11 Mod Codes	M10 Custom Keying M53 Space Grade Nano-D, SPT2	M50 Space Grade Nano-D, SPT1
12 Special Instructions	YYY Describe anything that is not covered in standard options	

DUAL ROW JUMPERS (TYPE JUM)

Omnetics' **Pre-Wired Dual Row Bi-Lobe®** harnesses are built to order by Omnetics to offer maximum flexibility in wire type, size, and color-coding. They are designed to accommodate 30 AWG and smaller stranded wire and feature .025" (.64 mm) centerlines, which makes them an excellent choice for routing multiple lines through confined spaces. They feature Omnetics' gold-plated Flex Pin contact system. Shell material options include aluminum, titanium, and stainless steel, with custom plating options available upon request. These connectors are available in standard sizes ranging from 9 to 91 positions, as well as custom configurations.

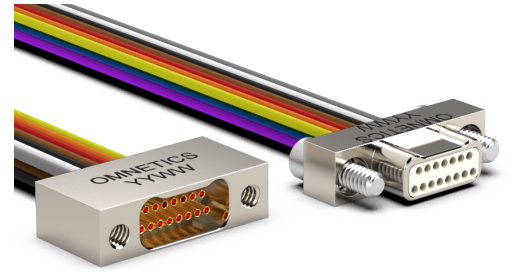

Electro-Mechanical Specifications

TYPE	PERFORMANCE
Durability	> 2000 Mating Cycles min
Temperature	-55°C to +125 °C (200 °C w/HTE)
Current rating	1 Amp per contact
Voltage Rating (DWV)	250 VAC RMS Sea Level
Insulation Resistance	5,000 Megohms @ 100 VDC
Shock	100 g's discontinuity < 10 nanoseconds
Vibration	20 g's discontinuity < 10 nanoseconds
Thermal Vacuum Outgassing	1.0% max TML, 0.1% VCM
Contact Resistance	71 milliohms (71 mV) max @ 1 Amp
Mating/Unmating Force	2.5 oz. (.71g) typical per contact

Material Specifications

TYPE	PERFORMANCE
Contact	Copper Alloy Per MIL-DTL-32139
Contact Finish	Gold per ASTM B488, Type II, Class 1.27, Code C Over Nickel Underplate
Insulator	LCP Per MIL-DTL-32139 Or PEEK
Encapsulant	Epoxy

Shell Options

TYPE	PERFORMANCE
Aluminum 6061	Electroless Nickel per SAE-AMS-2404
Stainless Steel, 300 Series	Passivated per SAE-AMS-2700

DUAL ROW MALE TO MALE JUMPERS (TYPE JUM)

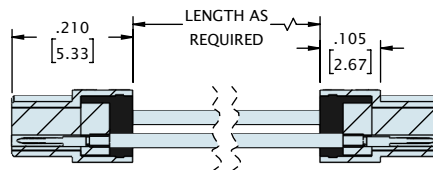
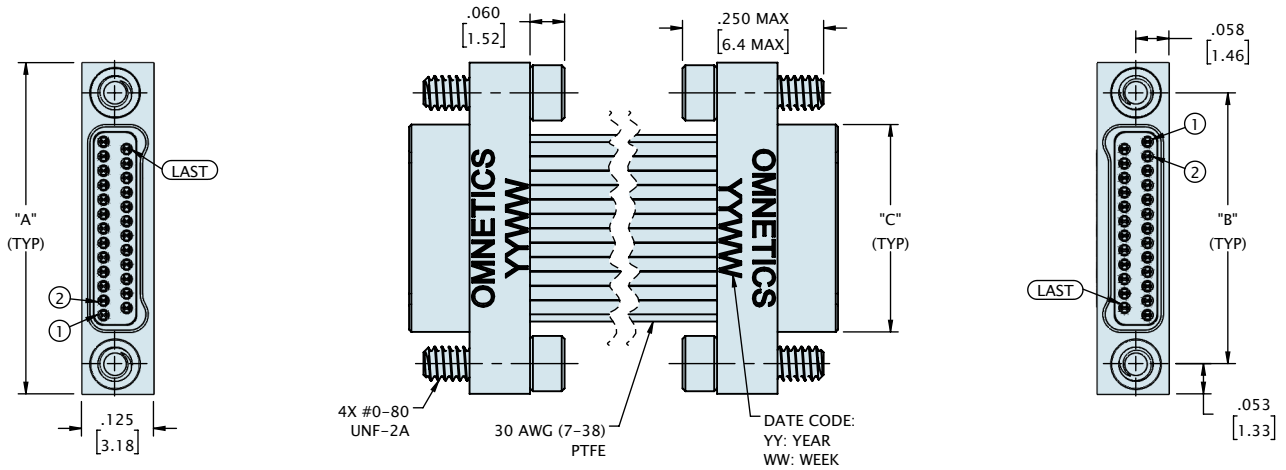
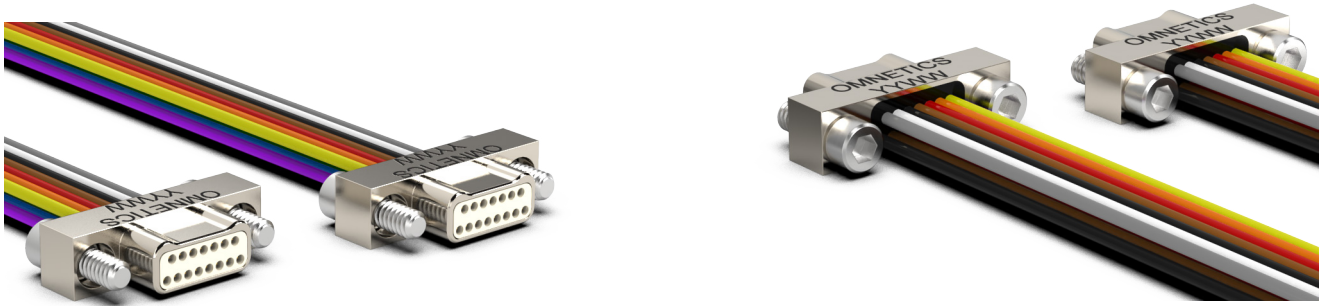

JACKSCREWS HIDDEN FOR CLARITY

CONTACTS	"A"	"B"	"C"
09	.375 [9.53]	.270 [6.86]	.160 [4.06]
15	.450 [11.43]	.345 [8.76]	.235 [5.97]
21	.525 [13.34]	.420 [10.67]	.310 [7.87]
25	.575 [14.61]	.470 [11.94]	.360 [9.14]
31	.650 [16.51]	.545 [13.84]	.435 [11.05]
37	.725 [18.42]	.620 [15.75]	.510 [12.95]
51	.900 [22.86]	.795 [20.19]	.685 [17.40]
65	1.075 [27.31]	.970 [24.64]	.860 [21.84]
69	1.125 [28.58]	1.020 [25.91]	.910 [23.11]
85	1.325 [33.66]	1.220 [30.99]	1.110 [28.19]
91	1.452 [36.88]	1.321 [33.55]	1.185 [30.10]

DIMENSIONS IN [] ARE IN MILLIMETERS AND ARE FOR REFERENCE ONLY

DUAL ROW MALE TO FEMALE JUMPERS (TYPE JUM)

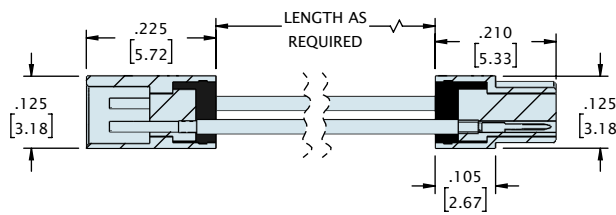
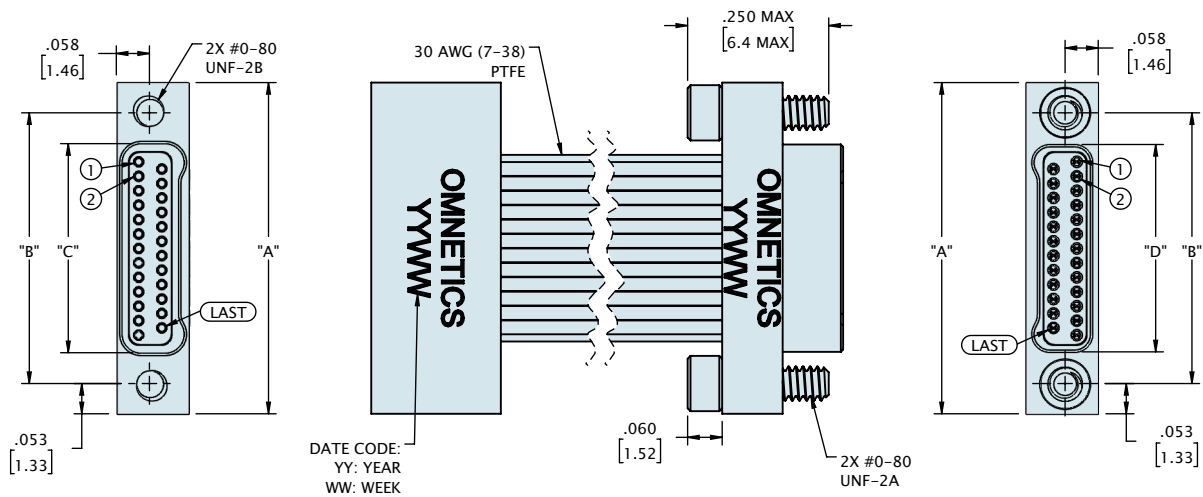
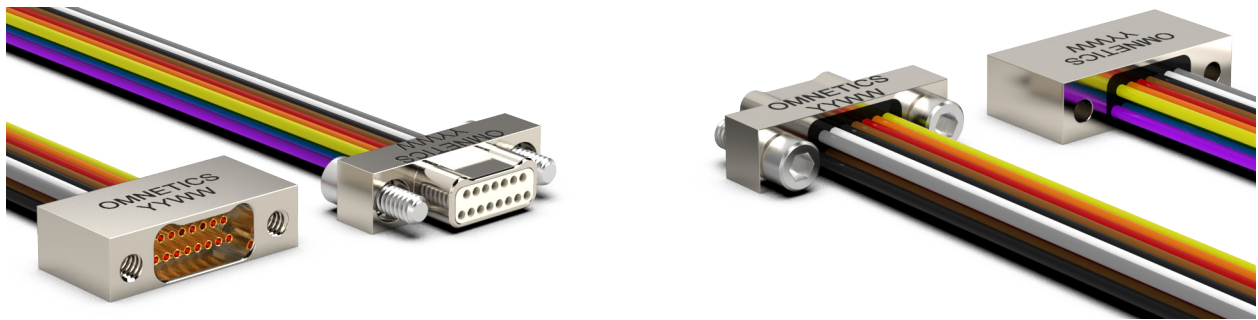

JACKSCREWS HIDDEN FOR CLARITY

CONTACTS	"A"	"B"	"C"	"D"
09	.375 [9.53]	.270 [6.86]	.163 [4.14]	.160 [4.06]
15	.450 [11.43]	.345 [8.75]	.238 [6.05]	.235 [5.97]
21	.525 [13.34]	.420 [10.67]	.313 [7.95]	.310 [7.87]
25	.575 [14.61]	.470 [11.94]	.363 [9.22]	.360 [9.14]
31	.650 [16.51]	.545 [13.84]	.438 [11.13]	.435 [11.05]
37	.725 [18.42]	.620 [15.75]	.513 [13.03]	.510 [12.95]
51	.900 [22.86]	.795 [20.19]	.688 [17.48]	.685 [17.40]
65	1.075 [27.31]	.970 [24.64]	.863 [21.92]	.860 [21.84]
69	1.125 [28.58]	1.020 [25.91]	.913 [23.19]	.910 [23.11]
85	1.325 [33.66]	1.220 [30.99]	1.113 [28.27]	1.110 [28.19]
91	1.452 [36.88]	1.321 [33.55]	1.188 [30.18]	1.185 [30.10]

DIMENSIONS IN [] ARE IN MILLIMETERS AND ARE FOR REFERENCE ONLY

DUAL ROW FEMALE TO FEMALE JUMPERS (TYPE JUM)

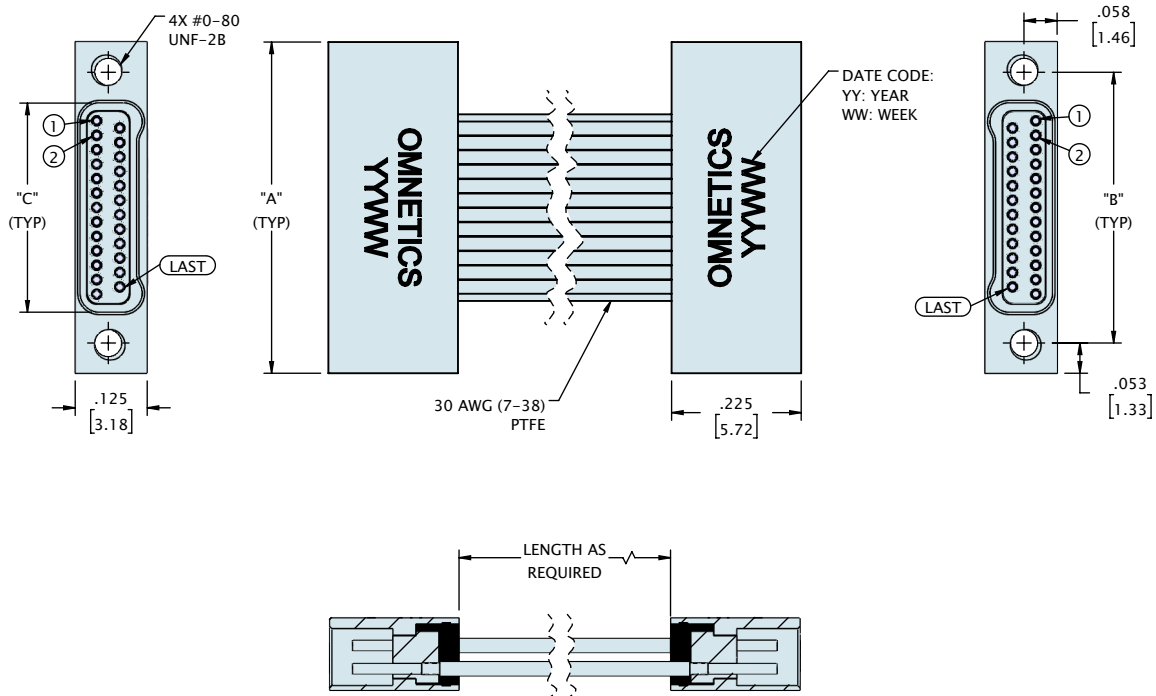
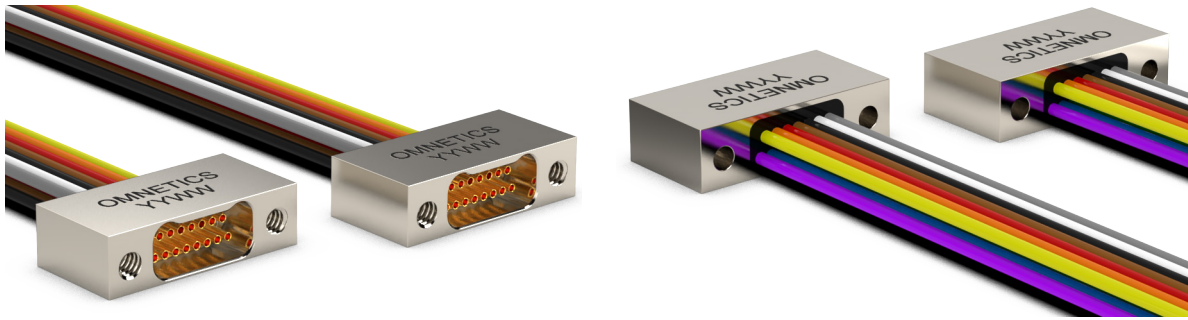

CONTACTS	"A"	"B"	"C"
09	.375 [9.53]	.270 [6.86]	.163 [4.14]
15	.450 [11.43]	.345 [8.75]	.238 [6.05]
21	.525 [13.34]	.420 [10.67]	.313 [7.95]
25	.575 [14.61]	.470 [11.94]	.363 [9.22]
31	.650 [16.51]	.545 [13.84]	.438 [11.13]
37	.725 [18.42]	.620 [15.75]	.513 [13.03]
51	.900 [22.86]	.795 [20.19]	.688 [17.48]
65	1.075 [27.31]	.970 [24.64]	.863 [21.92]
69	1.125 [28.58]	1.020 [25.91]	.913 [23.19]
85	1.325 [33.66]	1.220 [30.99]	1.113 [28.27]
91	1.452 [36.88]	1.321 [33.55]	1.188 [30.18]

DIMENSIONS IN [] ARE IN MILLIMETERS AND ARE FOR REFERENCE ONLY

DUAL ROW JUMPERS (TYPE JUM)

ORDERING GUIDE

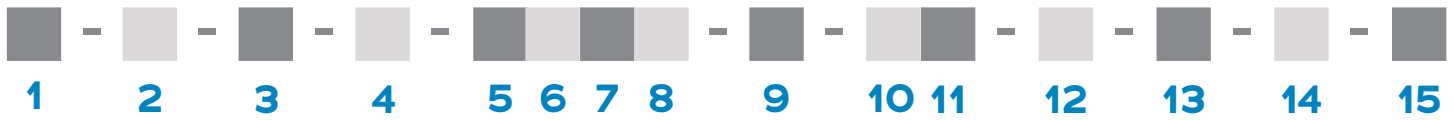

1 Series	JUM Jumpers											
2 Number Of Contacts	09	15	21	25	31	37	51	65	69	85	91	
3 Connector 1	MNPO Metal Nano Pin Offset						MNSO Metal Nano Socket Offset					
4 Connector 2	MNPO Metal Nano Pin Offset						MNSO Metal Nano Socket Offset					
5 Termination	WD Discrete Leadwire	WC Cable	WX Multiple Wire Types				TW Twisted Wires					
6 Wire AWG	0 30 AWG			2 32 AWG								
7 Wire Type	Q NEMA HP3			R M22759/11			S M22759/33			X Other Wire Types		
8 Wire Length	18.0					XX.X						
9 Color Coded	C 10 Repeating Colors Per MIL STD 681								Y All Other Wire Colors			
10 Shell / Material Finish	N Aluminum Shell, Electroless Nickel Plated						T Titanium Shell, Unplated					
	B Aluminium Shell, Black Anodized						CD Aluminium shell, Cadmium Plated					
	BN Aluminium Shell, Black Nickel Plated						P Stainless steel Shell, Passivated					
11 Hardware	See table page 49											
12 Common Options	See table page 49											
13 Shield / Jacket	D Slip On Metal Braid				E Machine Braid				F Flexo Braid			
	J Nomex Braid				ST Shrink Tube							
14 Mod Codes	M50 Space Grade Micro-D, SPT1						M53 Space Grade Micro-D, SPT2					
15 Special Instructions	YYY Describe anything that is not covered in standard options											

ORDERING GUIDE

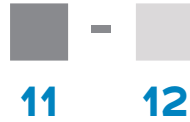

11 Hardware

- 00** None, Ø .092 Hole (STD)
- 01** Fixed Jack-Posts (STD)
- 02** Jackscrews, STD Length, Hex Head (STD)
- 03** Jackscrews, STD Length, Slotted
- 04** Jackscrews, Long, Hex
- 05** Jackscrews, Long, Slotted
- 06** Float Mount, Front Mounted
- 07** Float Mount, Rear Mounted
- 08** Non-removable
- 13** Fixed Jackspots (STD)
- 14** Jackscrews STD Length, Hex Head (STD)
- 15** One set of each, Fixed Jackspots & Jackscrews, Standard Length, Hex Head (STD)
- YY** Non Standard Hardware

12 Common Options

- | | |
|--------------------------------------|--|
| ETH End Threaded Hole, #0-80 | EJS End Jack Screw |
| HT High Temp. Epoxy | RH RoHS Compliant |
| FP Front Panel Mount | SR Strain Relief |
| CS Customer Supplied Material | RP Rear Panel Mount |
| IS Inline Shell | OR O-Ring |
| OM Overmold | BS1 Standard Straight Backshell |
| BS2 45 Oval | BS3 90/RA Oval |
| BS4 2 Piece BS | BSY Custom Backshell |

DUAL ROW PANEL MOUNT

Omnetics' **Dual Row Bi-Lobe**[®] nanos are available with panel mount housings, which enables designers to use minimal real estate to create a streamlined I/O arrangement. Their low mass and .025" (.64 mm) centerlines make them an excellent choice for applications that endure high degrees of shock and vibration. Retention screws ensure a positive lock and termination options include pre-wired, SMT, flex mount, and straight tails. These durable, lightweight connectors feature Omnetics' gold-plated Flex Pin contact system and can intermate with all MIL-DTL-32139 plugs. Shell material options include aluminum and stainless steel, with custom plating options available upon request.



Electro-Mechanical Specifications

TYPE	PERFORMANCE
Durability	> 2000 Mating Cycles min
Temperature	-55°C to +125 °C (200 °C w/HTE)
Current rating	1 Amp per contact
Voltage Rating (DWV)	250 VAC RMS Sea Level
Insulation Resistance	5,000 Megohms @ 100 VDC
Shock	100 g's discontinuity < 10 nanoseconds
Vibration	20 g's discontinuity < 10 nanoseconds
Thermal Vacuum Outgassing	1.0% max TML, 0.1% VCM
Contact Resistance	71 milliohms (71 mV) max @ 1 Amp
Mating/Unmating Force	2.5 oz. (.71g) typical per contact

Material Specifications

TYPE	PERFORMANCE
Contact	Copper Alloy Per MIL-DTL-32139
Contact Finish	Gold per ASTM B488, Type II, Class 1.27, Code C Over Nickel Underplate
Insulator	LCP Per MIL-DTL-32139 Or PEEK
Encapsulant	Epoxy

Shell Options

TYPE	PERFORMANCE
Aluminum 6061	Electroless Nickel per SAE-AMS-2404
Stainless Steel, 300 Series	Passivated per SAE-AMS-2700

DUAL RAW PANEL MOUNT (TYPE AA)

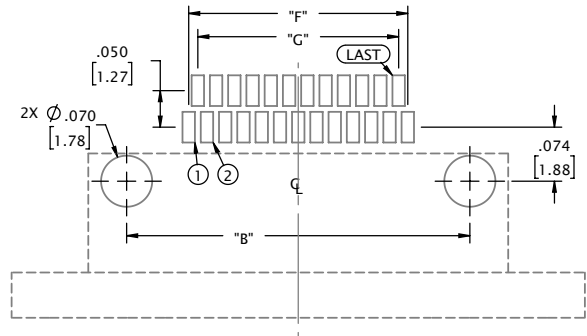
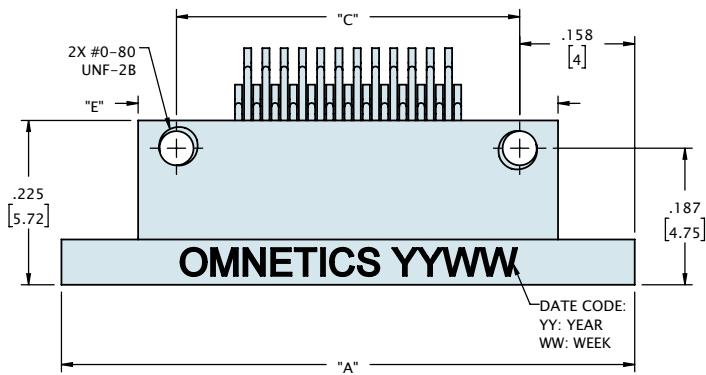
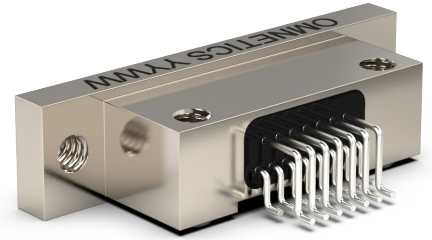

SUGGESTED PAD LAYOUT
(VIEW FROM MOUNTING SIDE OF BOARD)

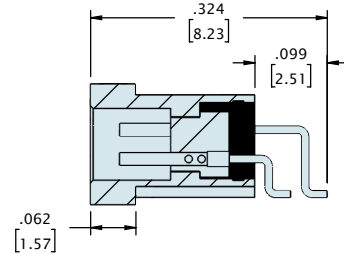
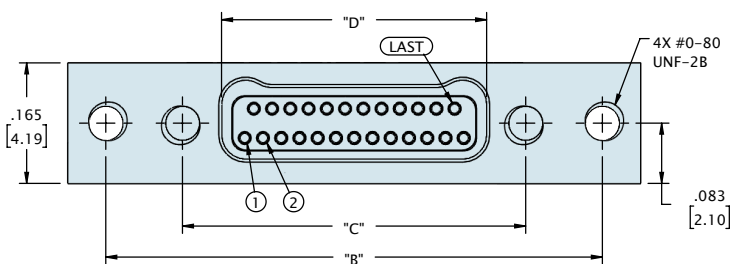

CONTACTS	"A"	"B"	"C"	"D"	"E"	"F"	"G"
09	.585 [14.86]	.480 [12.19]	.270 [6.86]	.163 [4.14]	.375 [9.53]	.100 [2.54]	.075 [1.91]
15	.660 [16.76]	.555 [14.10]	.345 [8.76]	.238 [6.05]	.450 [11.43]	.175 [4.45]	.150 [3.81]
21	.735 [18.67]	.630 [16.00]	.420 [10.67]	.313 [7.95]	.525 [13.34]	.250 [6.35]	.225 [5.72]
25	.785 [19.94]	.680 [17.27]	.470 [11.94]	.363 [9.22]	.575 [14.61]	.300 [7.62]	.275 [6.99]
31	.860 [21.84]	.755 [19.18]	.545 [13.84]	.438 [11.13]	.650 [16.51]	.375 [9.53]	.350 [8.89]
37	.935 [23.75]	.830 [21.08]	.620 [15.75]	.513 [13.03]	.725 [18.42]	.450 [11.43]	.425 [10.80]
51	1.110 [28.19]	1.005 [25.53]	.795 [20.19]	.688 [17.48]	.900 [22.86]	.625 [15.88]	.600 [15.24]
65	1.285 [32.64]	1.180 [29.97]	.970 [24.64]	.863 [21.92]	1.075 [27.31]	.800 [20.32]	.775 [19.69]
85	1.535 [38.99]	1.430 [36.32]	1.220 [30.99]	1.113 [28.27]	1.325 [33.66]	1.050 [26.67]	1.025 [26.04]

DIMENSIONS IN [] ARE IN MILLIMETERS AND ARE FOR REFERENCE ONLY

DUAL ROW PANEL MOUNT (TYPE DD)

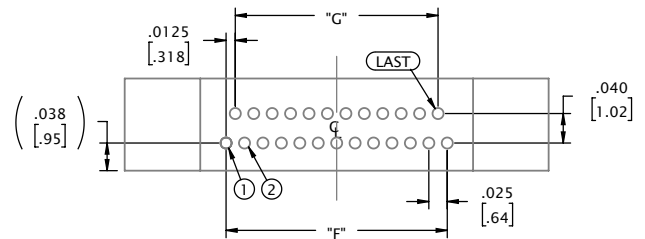
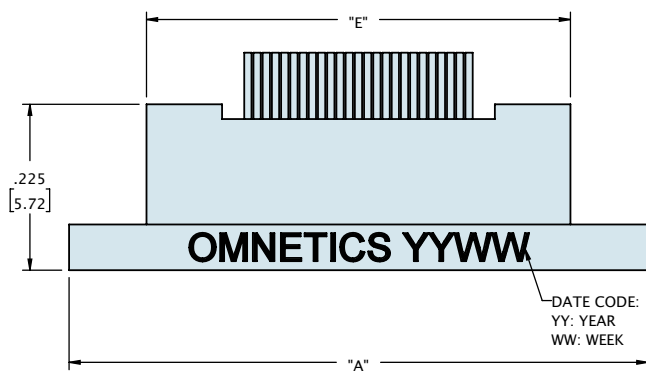
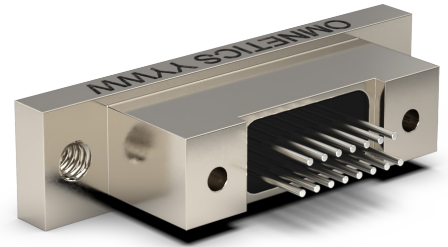

SUGGESTED PAD LAYOUT
(VIEW FROM MOUNTING SIDE OF BOARD)

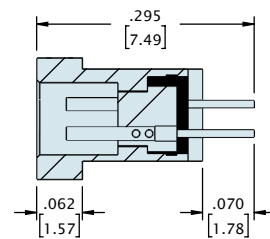
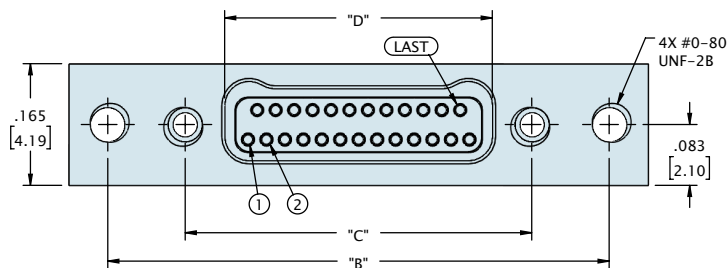

CONTACTS	"A"	"B"	"C"	"D"	"E"	"F"	"G"
9	.585 [14.86]	.480 [12.19]	.270 [6.86]	.163 [4.14]	.375 [9.53]	.100 [2.54]	.075 [1.91]
15	.660 [16.76]	.555 [14.10]	.345 [8.76]	.238 [6.05]	.450 [11.43]	.175 [4.45]	.150 [3.81]
21	.735 [18.67]	.630 [16.00]	.420 [10.67]	.313 [7.95]	.525 [13.34]	.250 [6.35]	.225 [5.72]
25	.785 [19.94]	.680 [17.27]	.470 [11.94]	.363 [9.22]	.575 [14.61]	.300 [7.62]	.275 [6.99]
31	.860 [21.84]	.755 [19.18]	.545 [13.84]	.438 [11.13]	.650 [16.51]	.375 [9.53]	.350 [8.89]
37	.935 [23.75]	.830 [21.08]	.620 [15.75]	.513 [13.03]	.725 [18.42]	.450 [11.43]	.425 [10.80]
51	1.110 [28.19]	1.005 [25.53]	.795 [20.19]	.688 [17.48]	.900 [22.86]	.625 [15.88]	.600 [15.24]
65	1.285 [32.64]	1.180 [29.97]	.970 [24.64]	.863 [21.92]	1.075 [27.31]	.800 [20.32]	.775 [19.69]
69	1.335 [33.91]	1.230 [31.24]	1.020 [25.91]	.913 [23.19]	1.125 [28.58]	.850 [21.59]	.825 [20.96]
85	1.535 [38.99]	1.430 [36.32]	1.220 [30.99]	1.113 [28.27]	1.325 [33.66]	1.050 [26.67]	1.025 [26.04]
91	1.636 [41.55]	1.531 [38.89]	1.321 [33.55]	1.188 [30.16]	1.400 [35.56]	1.125 [28.58]	1.100 [27.94]

DIMENSIONS IN [] ARE IN MILLIMETERS AND ARE FOR REFERENCE ONLY

DUAL RAW PANEL MOUNT (TYPE FF)

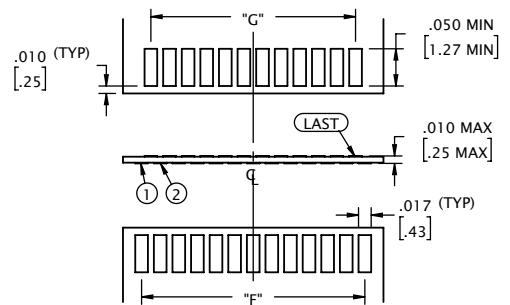
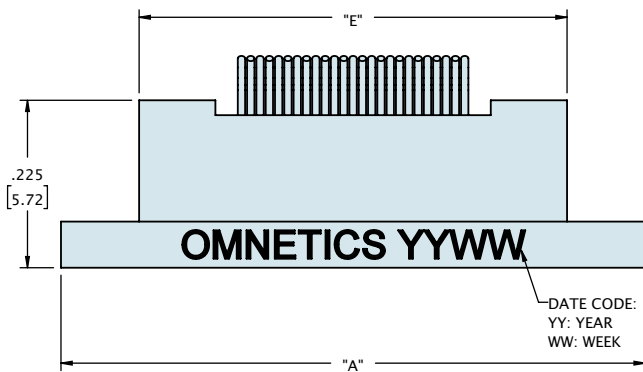
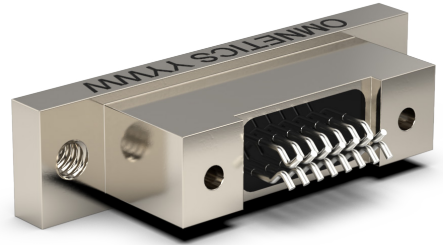

SUGGESTED PAD LAYOUT
(VIEW FROM MOUNTING SIDE OF BOARD)

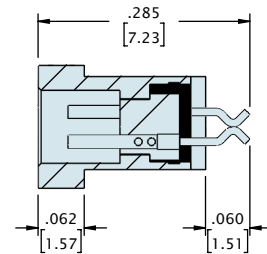
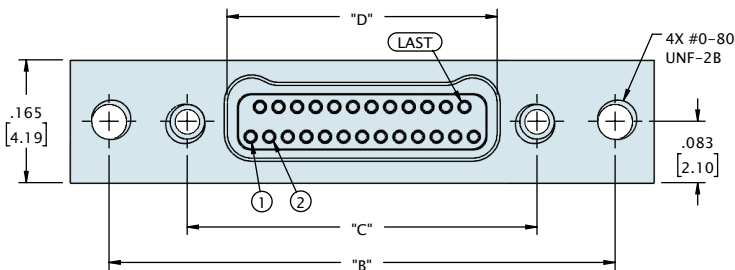

CONTACTS	"A"	"B"	"C"	"D"	"E"	"F"	"G"
9	.585 [14.86]	.480 [12.19]	.270 [6.86]	.163 [4.14]	.375 [9.53]	.100 [2.54]	.075 [1.91]
15	.660 [16.76]	.555 [14.10]	.345 [8.76]	.238 [6.05]	.450 [11.43]	.175 [4.45]	.150 [3.81]
21	.735 [18.67]	.630 [16.00]	.420 [10.67]	.313 [7.95]	.525 [13.34]	.250 [6.35]	.225 [5.72]
25	.785 [19.94]	.680 [17.27]	.470 [11.94]	.363 [9.22]	.575 [14.61]	.300 [7.62]	.275 [6.99]
31	.860 [21.84]	.755 [19.18]	.545 [13.84]	.438 [11.13]	.650 [16.51]	.375 [9.53]	.350 [8.89]
37	.935 [23.75]	.830 [21.08]	.620 [15.75]	.513 [13.03]	.725 [18.42]	.450 [11.43]	.425 [10.80]
51	1.110 [28.19]	1.005 [25.53]	.795 [20.19]	.688 [17.48]	.900 [22.86]	.625 [15.88]	.600 [15.24]
65	1.285 [32.64]	1.180 [29.97]	.970 [24.64]	.863 [21.92]	1.075 [27.31]	.800 [20.32]	.775 [19.69]
85	1.535 [38.99]	1.430 [36.32]	1.220 [30.99]	1.113 [28.27]	1.325 [33.66]	1.050 [26.67]	1.025 [26.04]

DIMENSIONS IN [] ARE IN MILLIMETERS AND ARE FOR REFERENCE ONLY

DUAL ROW PANEL MOUNT (TYPE WD)

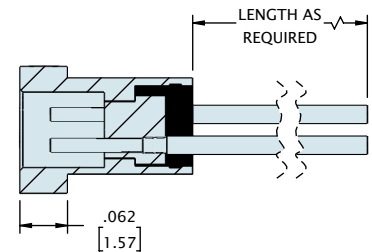
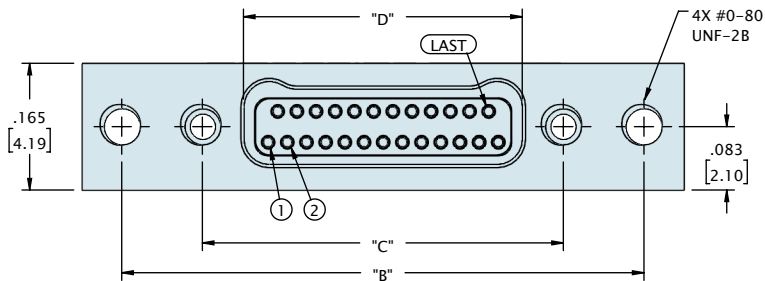
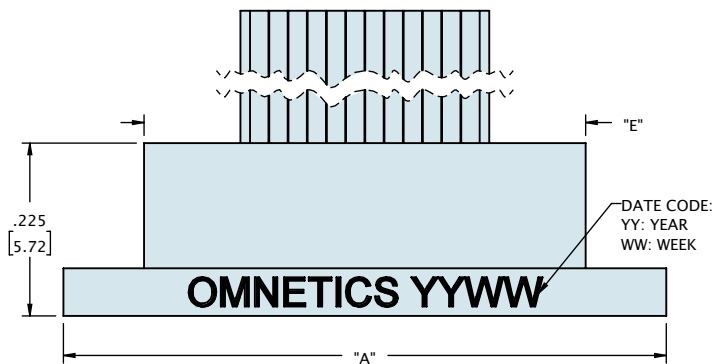

CONTACTS	"A"	"B"	"C"	"D"	"E"
9	.585 [14.86]	.480 [12.19]	.270 [6.86]	.163 [4.14]	.375 [9.53]
15	.660 [16.76]	.555 [14.10]	.345 [8.76]	.238 [6.05]	.450 [11.43]
21	.735 [18.67]	.630 [16.00]	.420 [10.67]	.313 [7.95]	.525 [13.34]
25	.785 [19.94]	.680 [17.27]	.470 [11.94]	.363 [9.22]	.575 [14.61]
31	.860 [21.84]	.755 [19.18]	.545 [13.84]	.438 [11.13]	.650 [16.51]
37	.935 [23.75]	.830 [21.08]	.620 [15.75]	.513 [13.03]	.725 [18.42]
51	1.110 [28.19]	1.005 [25.53]	.795 [20.19]	.688 [17.48]	.900 [22.86]
65	1.285 [32.64]	1.180 [29.97]	.970 [24.64]	.863 [21.92]	1.075 [27.31]
85	1.535 [38.99]	1.430 [36.32]	1.220 [30.99]	1.113 [28.27]	1.325 [33.66]

DIMENSIONS IN [] ARE IN MILLIMETERS AND ARE FOR REFERENCE ONLY

ORDERING GUIDE

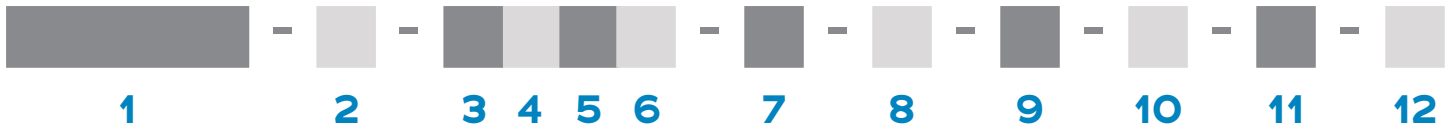

1 Series	MNSOP Metal Nano Socket Offset Panel											
2 Number Of Contacts	09	15	21	25	31	37	51	65	69	85	91	
3 Termination Type	A Horizontal Surface Mount						DD Thru-Hole Straight					
	FF Flex Mount						WD Discrete Wires					
4 Wire Gage*	0 30 AWG (STD)					2 32 AWG						
5 Wire Type*	Q NEMA HP3 (formerly M16878/4 and /6)							XX.X M22759/33 (30 AWG only)				
6 Wire Length*	18.0 18.00" (STD)							XX.X Custom Length				
7 Color Scheme*	C 10 repeating colors per MIL STD 681							Y All other wire colors				
8 Shell Material & Finish	N Aluminum Shell, Electroless Nickel Plated						CD Aluminium shell, Cadmium Plated					
	B Aluminium Shell, Black Anodized						S Stainless steel Shell, Passivated					
	T Titanium Shell, Unplated											
9 Common Options	ETH End Threaded Hole, #0-80						EJS End Jack Screw					
	NTH Non-Threaded Holes for mounting to the board											
	YY Non Standard Hardware (threaded holes, thumb screws, #2-56 screw)											
	HT High Temp. Epoxy						RH RoHS Compliant					
	CS Customer Supplied Material											
10 Shield / Jacket*	D Slip-on Braid	E Machine Braid	F Flexo Braid	J Nomex Braid	ST Shrink Tube							
11 Mod Codes	M10 Custom Keying						M50 Space Grade Nano-D, SPT1					
	M53 Space Grade Nano-D, SPT2											
12 Special Instructions	YYY Describe anything that is not covered in standard options											

* WD only

DUAL ROW LATCHING BI-LOBE®

Omnetics' **Bi-Lobe®** connectors are available in a quick-latch version. This option requires no tools and makes it very easy for operators to achieve a secure connection in the field. These durable, lightweight connectors feature Omnetics' gold-plated Flex Pin contact system and ensure connectivity in the most demanding applications. They are spaced on .025" (.64 mm) centerlines and can carry 1 amp per contact. These connectors are available in standard sizes ranging from 9 to 65 positions, and can be configured with discrete wires, over-molded cable, panel mount housings, and PCB-mounted versions.



Electro-Mechanical Specifications

TYPE	PERFORMANCE
Durability	> 2000 Mating Cycles min
Temperature	-55°C to +125 °C (200 °C w/HTE)
Current rating	1 Amp per contact
Voltage Rating (DWV)	250 VAC RMS Sea Level
Insulation Resistance	5,000 Megohms @ 100 VDC
Shock	100 g's discontinuity < 10 nanoseconds
Vibration	20 g's discontinuity < 10 nanoseconds
Thermal Vacuum Outgassing	1.0% max TML, 0.1% VCM
Contact Resistance	71 milliohms (71 mV) max @ 1 Amp
Mating/Unmating Force	2.5 oz. (.71g) typical per contact

Material Specifications

TYPE	PERFORMANCE
Contact	Copper Alloy Per MIL-DTL-32139
Contact Finish	Gold per ASTM B488, Type II, Class 1.27, Code C Over Nickel Underplate
Insulator	LCP Per MIL-DTL-32139 Or PEEK
Encapsulant	Epoxy

Shell Options

TYPE	PERFORMANCE
Aluminum 6061	Electroless Nickel per SAE-AMS-2404
Stainless Steel, 300 Series	Passivated per SAE-AMS-2700

DUAL ROW LATCHING BI-LOBE® (TYPE AA)

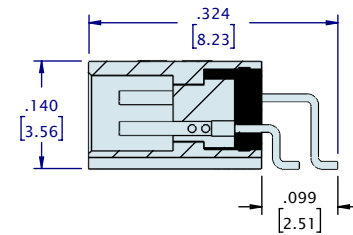
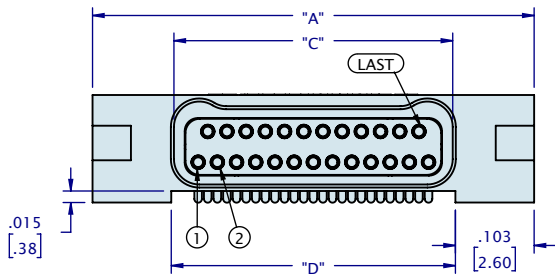
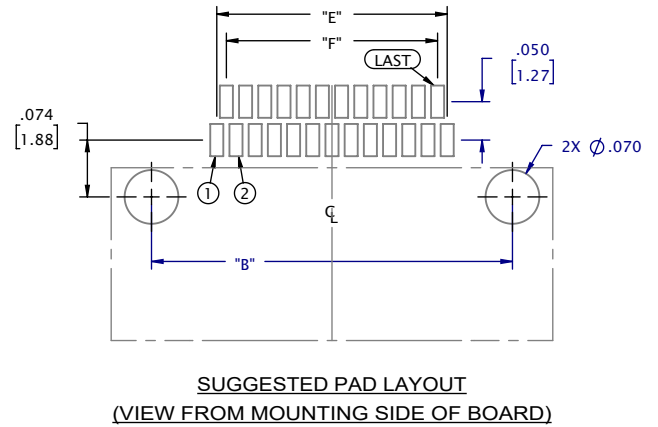
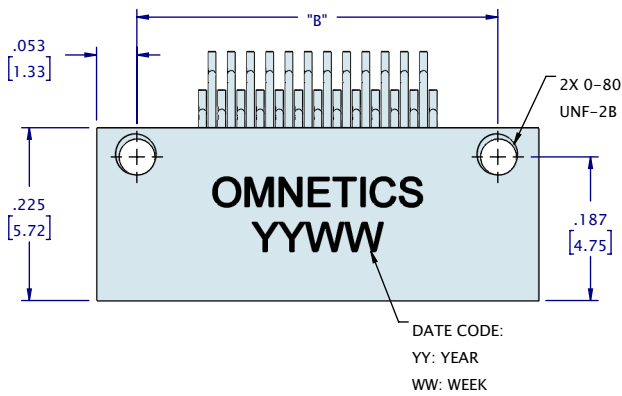
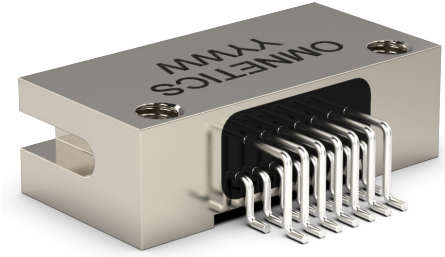
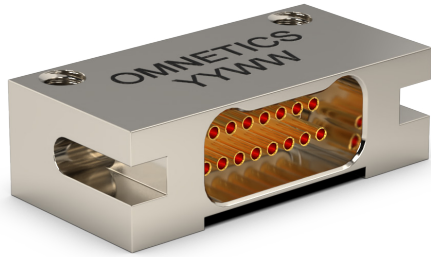

CONTACTS	"A"	"B"	"C"	"D"	"E"	"F"
09	.375 [9.53]	.270 [6.86]	.163 [4.14]	.170 [4.32]	.100 [2.54]	.075 [1.91]
15	.450 [11.43]	.345 [8.76]	.238 [6.05]	.245 [6.22]	.175 [4.45]	.150 [3.81]
21	.525 [13.34]	.420 [10.67]	.313 [7.95]	.320 [8.13]	.250 [6.35]	.225 [5.72]
25	.575 [14.61]	.470 [11.94]	.363 [9.22]	.370 [9.40]	.300 [7.62]	.275 [6.99]
31	.650 [16.51]	.545 [13.84]	.438 [11.13]	.445 [11.30]	.375 [9.53]	.350 [8.89]
37	.725 [18.42]	.620 [15.75]	.513 [13.03]	.520 [13.21]	.450 [11.43]	.425 [10.80]
51	.900 [22.86]	.795 [20.19]	.688 [17.48]	.695 [17.65]	.625 [15.88]	.600 [15.24]
65	1.075 [27.31]	.970 [24.64]	.863 [21.92]	.870 [22.10]	.800 [20.32]	.775 [19.69]

DIMENSIONS IN [] ARE IN MILLIMETERS AND ARE FOR REFERENCE ONLY

DUAL ROW LATCHING BI-LOBE® (TYPE AA)

PANEL MOUNT

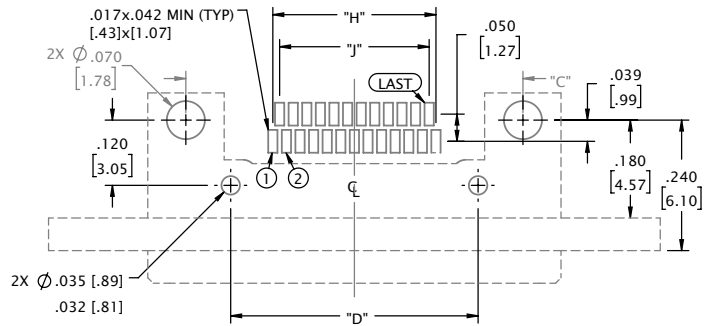
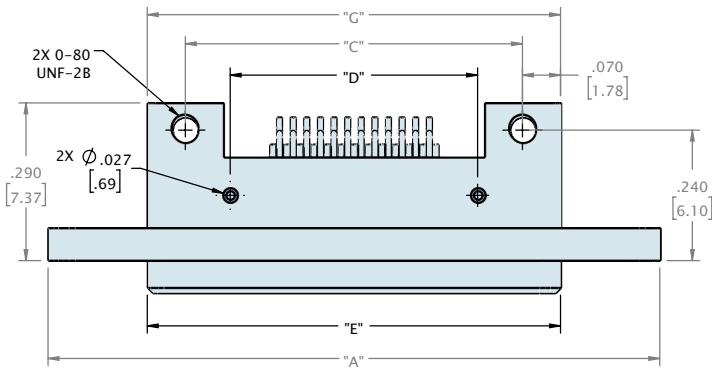
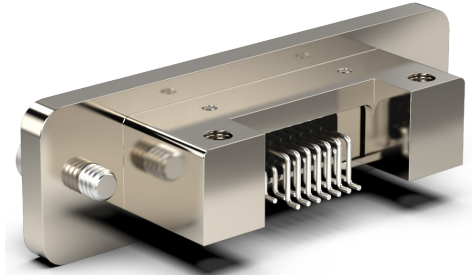

SUGGESTED PAD LAYOUT
(VIEW FROM MOUNTING SIDE OF BOARD)

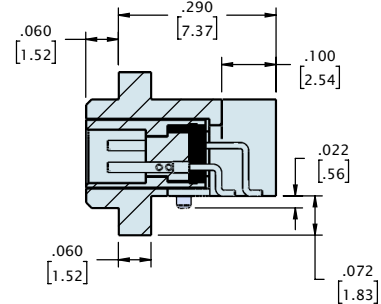
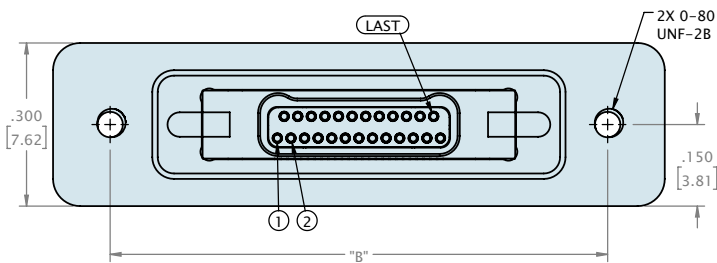

CONTACTS	"A"	"B"	"C"	"D"	"E"	"F"	"G"	"H"	"J"
09	.925 [23.50]	.715 [18.16]	.420 [10.67]	.255 [6.48]	.560 [14.22]	.279 [7.09]	.560 [14.22]	.075 [1.91]	.100 [2.54]
15	1.000 [25.40]	.790 [20.07]	.495 [12.57]	.330 [8.38]	.635 [16.13]	.354 [8.99]	.635 [16.13]	.150 [3.81]	.175 [4.45]
21	1.075 [27.31]	.865 [21.97]	.570 [14.48]	.405 [10.29]	.710 [18.03]	.429 [10.90]	.710 [18.03]	.225 [5.72]	.250 [6.35]
25	1.125 [28.58]	.915 [23.24]	.620 [15.75]	.455 [11.56]	.760 [19.30]	.479 [12.17]	.760 [19.30]	.275 [6.99]	.300 [7.62]
31	1.200 [30.48]	.990 [25.15]	.695 [17.65]	.530 [13.46]	.835 [21.21]	.554 [14.07]	.835 [21.21]	.350 [8.89]	.375 [9.53]
37	1.275 [32.39]	1.065 [27.05]	.770 [19.56]	.605 [15.37]	.910 [23.11]	.629 [15.98]	.910 [23.11]	.425 [10.80]	.450 [11.43]
51	1.450 [36.83]	1.240 [31.50]	.945 [24.00]	.780 [19.81]	1.085 [27.56]	.804 [20.42]	1.085 [27.56]	.600 [15.24]	.625 [15.88]
65	1.625 [41.28]	1.415 [35.94]	1.120 [28.45]	.955 [24.26]	1.260 [32.00]	.979 [24.87]	1.260 [32.00]	.775 [19.69]	.800 [20.32]

DIMENSIONS IN [] ARE IN MILLIMETERS AND ARE FOR REFERENCE ONLY

DUAL ROW LATCHING BI-LOBE® (TYPE DD)

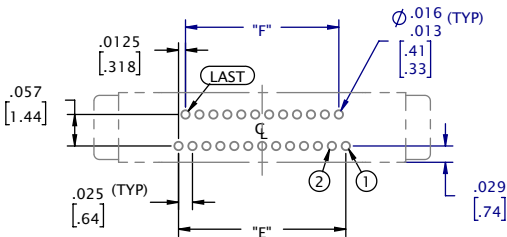
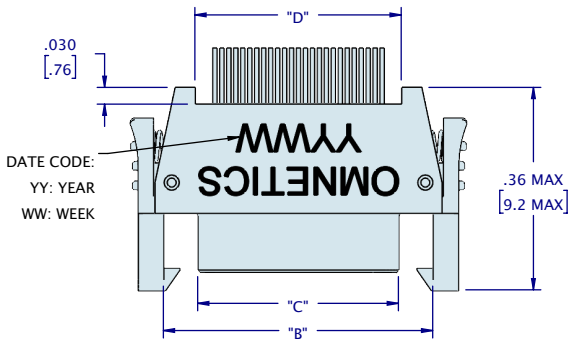
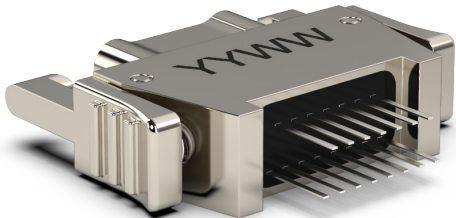
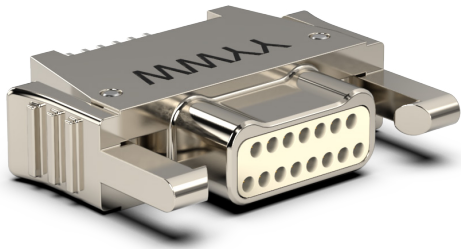

SUGGESTED PAD LAYOUT
(VIEW FROM MOUNTING SIDE OF BOARD)

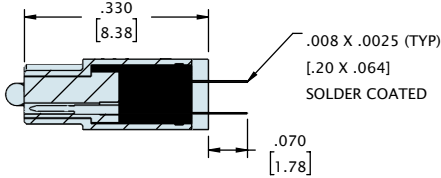
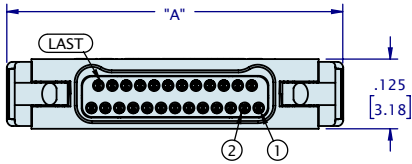

CONTACTS	"A"	"B"	"C"	"D"	"E"	"F"
09	.403 [10.25]	.283 [7.19]	.160 [4.06]	.170 [4.32]	.100 [2.54]	.075 [1.91]
15	.478 [12.15]	.358 [9.09]	.235 [5.97]	.245 [6.22]	.175 [4.45]	.150 [3.81]
21	.553 [14.06]	.433 [11.00]	.310 [7.87]	.320 [8.13]	.250 [6.35]	.225 [5.72]
25	.603 [15.33]	.483 [12.27]	.360 [9.14]	.370 [9.40]	.300 [7.62]	.275 [6.99]
31	.678 [17.23]	.558 [14.17]	.435 [11.05]	.445 [11.30]	.375 [9.53]	.350 [8.89]
37	.753 [19.14]	.633 [16.08]	.510 [12.95]	.520 [13.21]	.450 [11.43]	.425 [10.80]
51	.928 [23.58]	.808 [20.52]	.685 [17.40]	.695 [17.65]	.625 [15.88]	.600 [15.24]
65	1.103 [28.03]	.983 [24.97]	.860 [21.84]	.870 [22.10]	.800 [20.32]	.775 [19.69]

DIMENSIONS IN [] ARE IN MILLIMETERS AND ARE FOR REFERENCE ONLY

DUAL ROW LATCHING BI-LOBE® (TYPE DD)

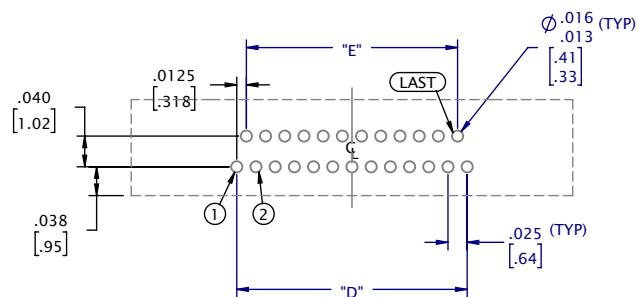
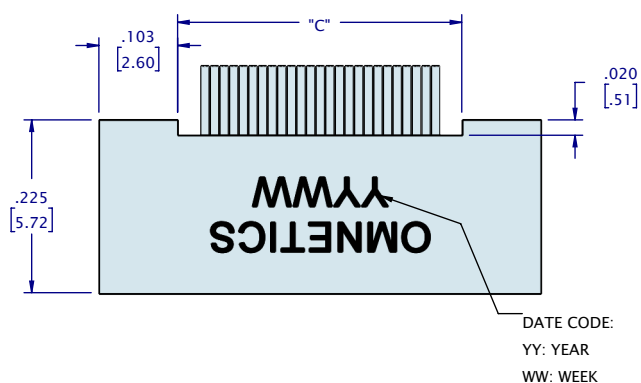
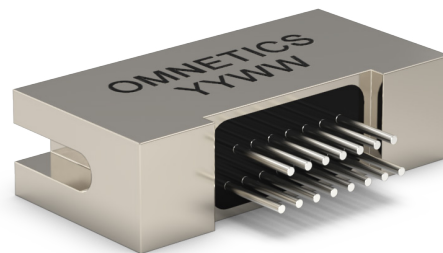

SUGGESTED PAD LAYOUT
(VIEW FROM MOUNTING SIDE OF BOARD)

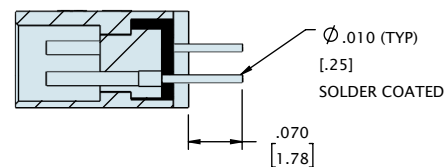
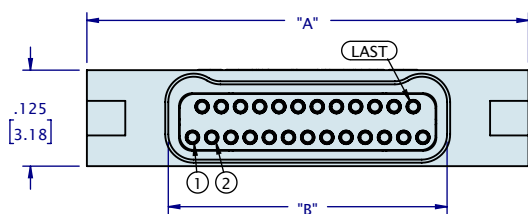

CONTACTS	"A"	"B"	"C"	"D"	"E"
09	.375 [9.53]	.163 [4.14]	.170 [4.32]	.100 [2.54]	.075 [1.91]
15	.450 [11.43]	.238 [6.05]	.245 [6.22]	.175 [4.45]	.150 [3.81]
21	.525 [13.34]	.313 [7.95]	.320 [8.13]	.250 [6.35]	.225 [5.72]
25	.575 [14.61]	.363 [9.22]	.370 [9.40]	.300 [7.62]	.275 [6.99]
31	.650 [16.51]	.438 [11.13]	.445 [11.30]	.375 [9.53]	.350 [8.89]
37	.725 [18.42]	.513 [13.03]	.520 [13.21]	.450 [11.43]	.425 [10.80]
51	.900 [22.86]	.688 [17.48]	.695 [17.65]	.625 [15.88]	.600 [15.24]
65	1.075 [27.31]	.863 [21.92]	.870 [22.10]	.800 [20.32]	.775 [19.69]

DIMENSIONS IN [] ARE IN MILLIMETERS AND ARE FOR REFERENCE ONLY

DUAL ROW LATCHING BI-LOBE® (TYPE DD)

PANEL MOUNT

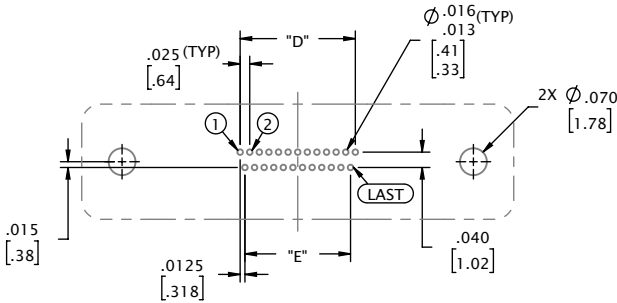
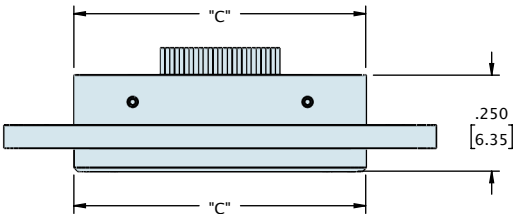
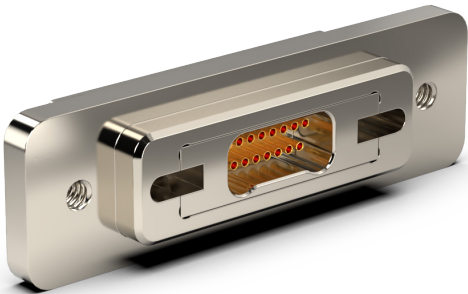

SUGGESTED PAD LAYOUT
(VIEW FROM MOUNTING SIDE OF BOARD)

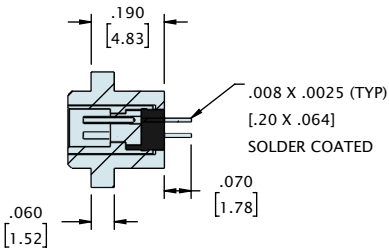
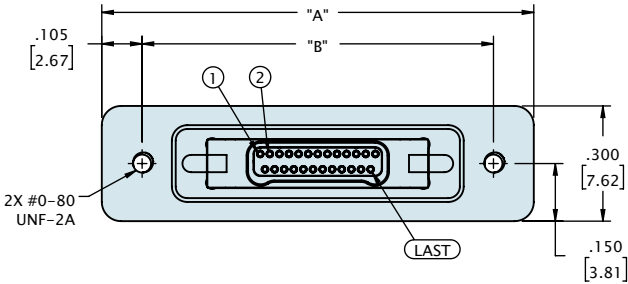

CONTACTS	"A"	"B"	"C"	"D"	"E"
09	.925 [23.50]	.715 [18.16]	.560 [14.22]	.100 [2.54]	.075 [1.91]
15	1.000 [25.40]	.790 [20.07]	.635 [16.13]	.175 [4.45]	.150 [3.81]
21	1.075 [27.31]	.865 [21.97]	.710 [18.03]	.250 [6.35]	.225 [5.72]
25	1.125 [28.58]	.915 [23.24]	.760 [19.30]	.300 [7.62]	.275 [6.99]
31	1.200 [30.48]	.990 [25.15]	.835 [21.21]	.375 [9.53]	.350 [8.89]
37	1.275 [32.39]	1.065 [27.05]	.910 [23.11]	.450 [11.43]	.425 [10.80]
51	1.450 [36.83]	1.240 [31.50]	1.085 [27.56]	.625 [15.88]	.600 [15.24]
65	1.625 [41.28]	1.415 [35.94]	1.260 [32.00]	.800 [20.32]	.775 [19.69]

DUAL ROW LATCHING BI-LOBE® (TYPE FF)

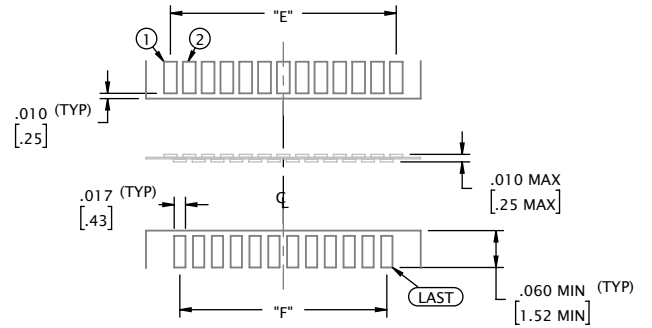
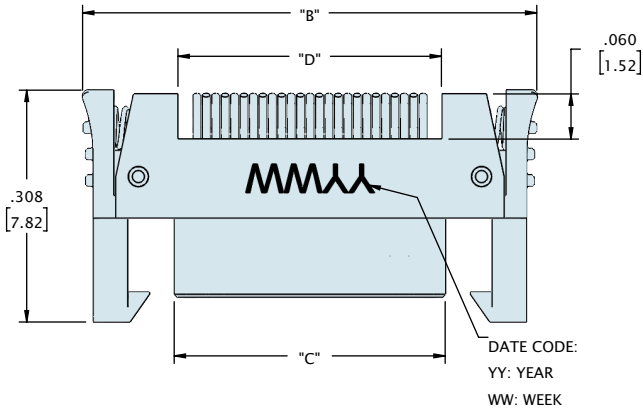
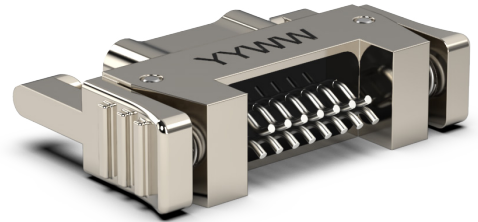
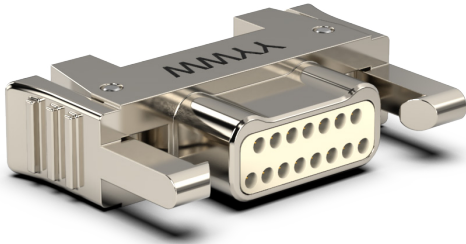

SUGGESTED PAD LAYOUT
(VIEW FROM MOUNTING SIDE OF BOARD)

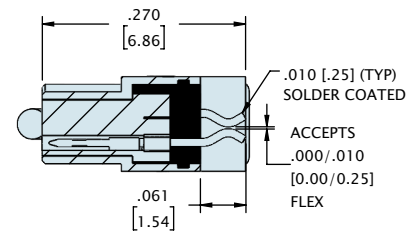
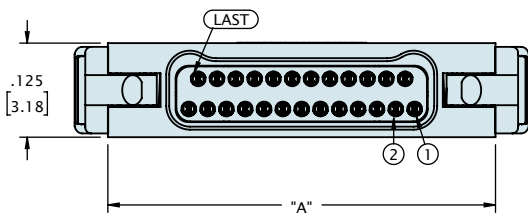

CONTACTS	"A"	"B"	"C"	"D"	"E"	"F"
09	.404 [10.25]	.283 [7.19]	.160 [4.06]	.150 [3.81]	.100 [2.54]	.075 [1.90]
15	.479 [12.15]	.358 [9.09]	.235 [5.97]	.225 [5.72]	.175 [4.45]	.150 [3.81]
21	.554 [14.06]	.433 [11.00]	.310 [7.87]	.300 [7.62]	.250 [6.35]	.225 [5.71]
25	.604 [15.33]	.483 [12.27]	.360 [9.14]	.350 [8.89]	.300 [7.62]	.275 [6.98]
31	.679 [17.23]	.558 [14.17]	.435 [11.05]	.425 [10.80]	.375 [9.53]	.350 [8.89]
37	.754 [19.14]	.633 [16.08]	.510 [12.95]	.500 [12.70]	.450 [11.43]	.425 [10.79]
51	.929 [23.58]	.808 [20.52]	.685 [17.40]	.675 [17.15]	.625 [15.88]	.600 [15.24]
65	1.104 [28.03]	.983 [24.97]	.860 [21.84]	.850 [21.59]	.800 [20.32]	.775 [19.68]

DIMENSIONS IN [] ARE IN MILLIMETERS AND ARE FOR REFERENCE ONLY

DUAL ROW LATCHING BI-LOBE® (TYPE FF)

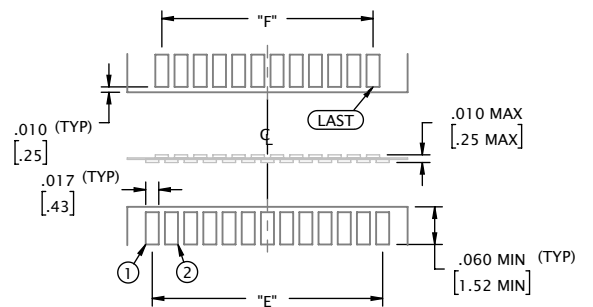
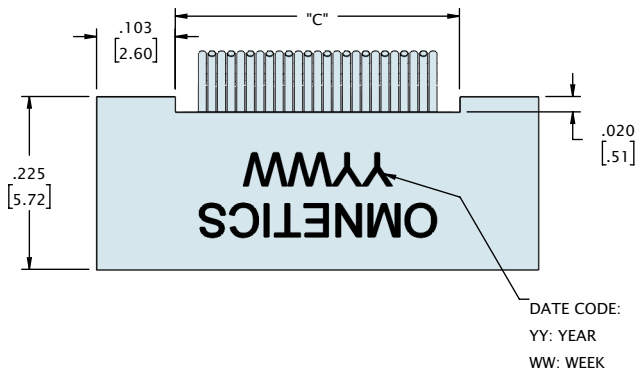
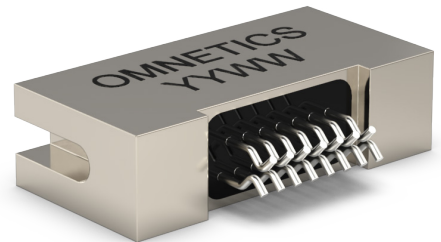
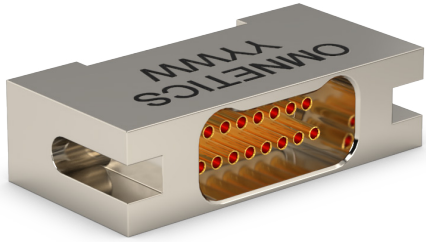

SUGGESTED PAD LAYOUT
(VIEW FROM MOUNTING SIDE OF BOARD)

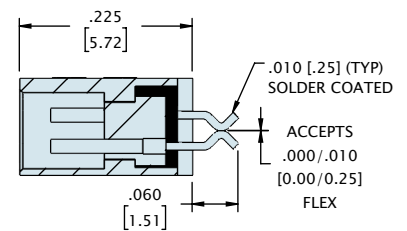
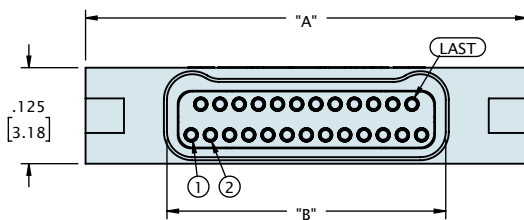

CONTACTS	"A"	"B"	"C"	"D"	"E"
09	.375 [9.53]	.163 [4.14]	.170 [4.32]	.100 [2.54]	.075 [1.91]
15	.450 [11.43]	.238 [6.05]	.245 [6.22]	.175 [4.44]	.150 [3.81]
21	.525 [13.34]	.313 [7.95]	.320 [8.13]	.250 [6.35]	.225 [5.72]
25	.575 [14.61]	.363 [9.22]	.370 [9.40]	.300 [7.62]	.275 [6.99]
31	.650 [16.51]	.438 [11.13]	.445 [11.30]	.375 [9.52]	.350 [8.89]
37	.725 [18.42]	.513 [13.03]	.520 [13.21]	.450 [11.43]	.425 [10.80]
51	.900 [22.86]	.688 [17.48]	.695 [17.65]	.625 [15.88]	.600 [15.24]
65	1.075 [27.31]	.863 [21.92]	.870 [22.10]	.800 [20.32]	.775 [19.69]

DIMENSIONS IN [] ARE IN MILLIMETERS AND ARE FOR REFERENCE ONLY

DUAL ROW LATCHING BI-LOBE® (TYPE H4)

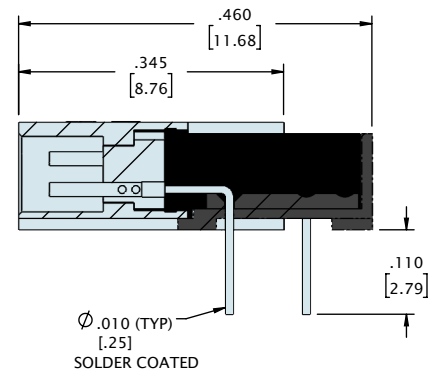
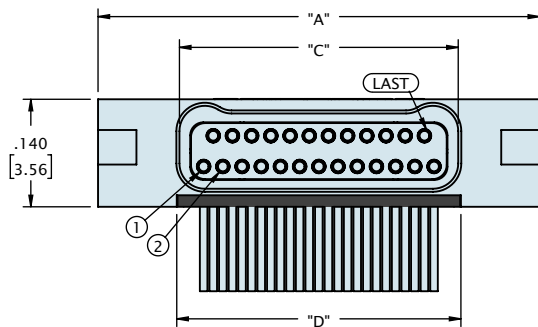
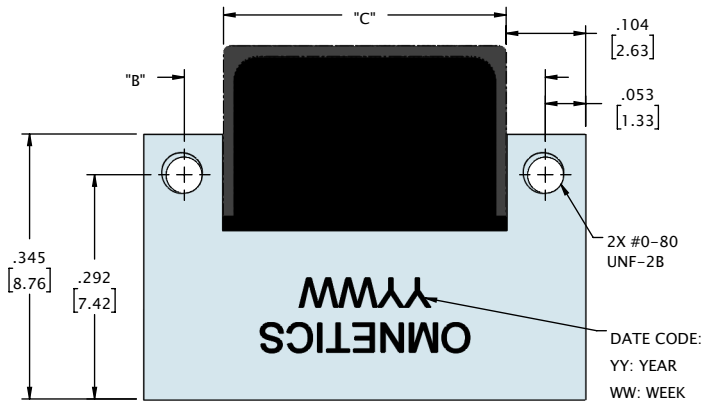
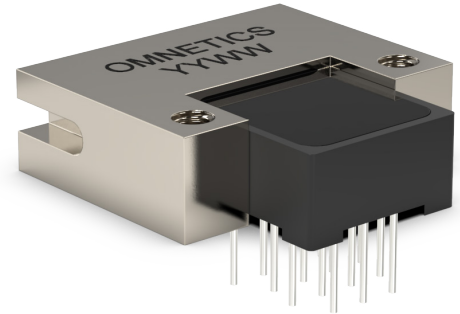
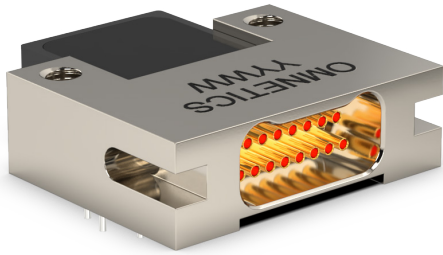

CONTACTS	"A"	"B"	"C"	"D"
09	.375 [9.53]	.270 [6.86]	.163 [4.14]	.170 [4.32]
15	.450 [11.43]	.345 [8.76]	.238 [6.05]	.245 [6.22]
21	.525 [13.34]	.420 [10.67]	.313 [7.95]	.320 [8.13]
25	.575 [14.61]	.470 [11.94]	.363 [9.22]	.370 [9.40]
31	.650 [16.51]	.545 [13.84]	.438 [11.13]	.445 [11.30]
37	.725 [18.42]	.620 [15.75]	.513 [13.03]	.520 [13.21]
51	.900 [22.86]	.795 [20.19]	.688 [17.48]	.695 [17.65]
65	1.075 [27.31]	.970 [24.64]	.863 [21.92]	.870 [22.10]

DIMENSIONS IN [] ARE IN MILLIMETERS AND ARE FOR REFERENCE ONLY

DUAL ROW LATCHING BI-LOBE® (TYPE H4)

9 CONTACT SOCKET

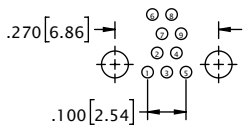

21 CONTACT SOCKET

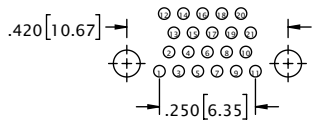

31 CONTACT SOCKET

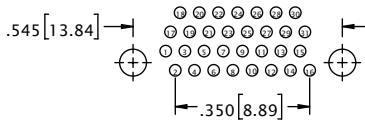

51 CONTACT SOCKET

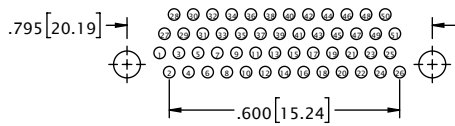

15 CONTACT SOCKET

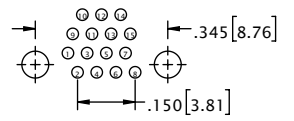

25 CONTACT SOCKET

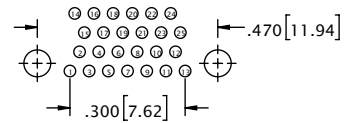

37 CONTACT SOCKET

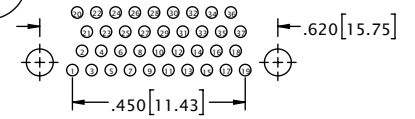

65 CONTACT SOCKET

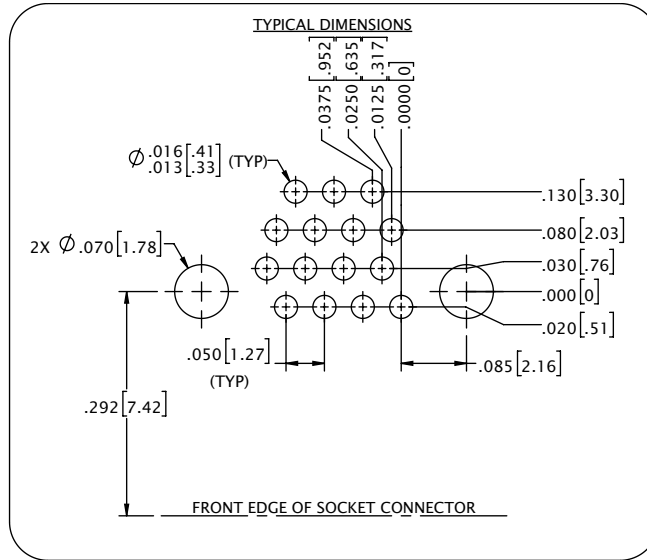
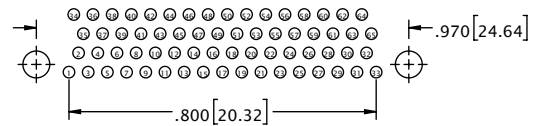

DUAL ROW LATCHING BI-LOBE® (TYPE VV)

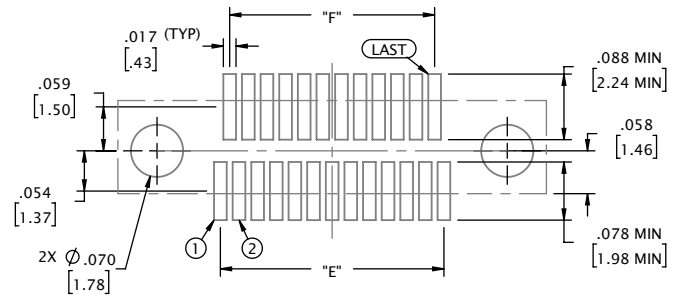
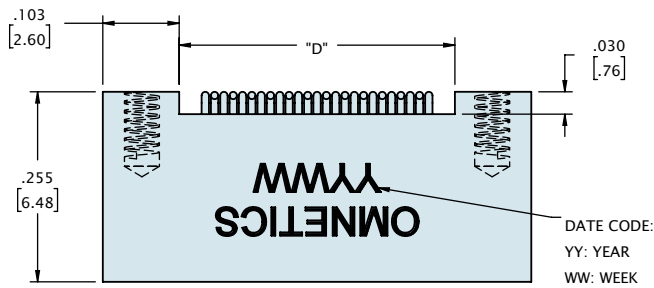
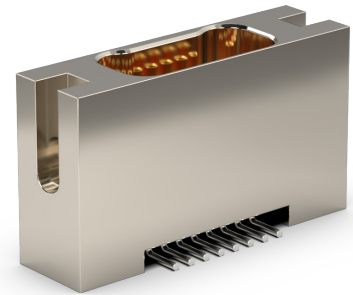
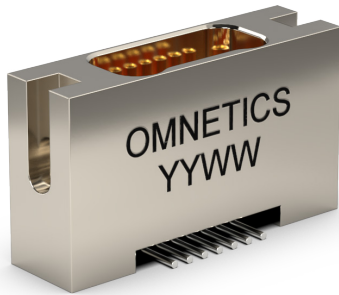

SUGGESTED PAD LAYOUT
(VIEW FROM MOUNTING SIDE OF BOARD)

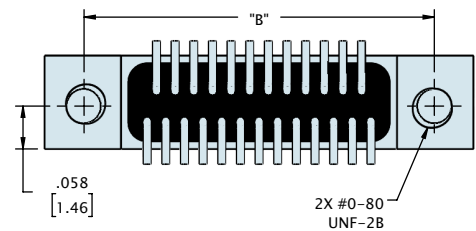
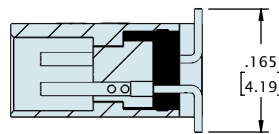
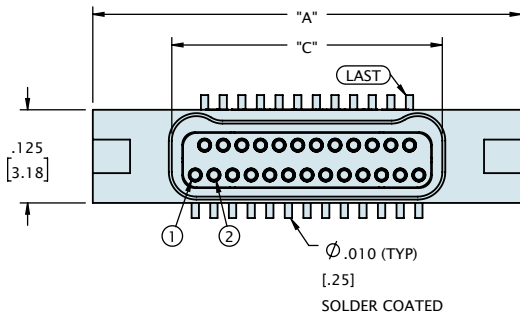

CONTACTS	"A"	"B"	"C"	"D"	"E"	"F"
09	.375 [9.53]	.270 [6.86]	.163 [4.14]	.170 [4.32]	.100 [2.54]	.075 [1.91]
15	.450 [11.43]	.345 [8.76]	.238 [6.05]	.245 [6.22]	.175 [4.45]	.150 [3.81]
21	.525 [13.34]	.420 [10.67]	.313 [7.95]	.320 [8.13]	.250 [6.35]	.225 [5.72]
25	.575 [14.61]	.470 [11.94]	.363 [9.22]	.370 [9.40]	.300 [7.62]	.275 [6.99]
31	.650 [16.51]	.545 [13.84]	.438 [11.13]	.445 [11.30]	.375 [9.53]	.350 [8.89]
37	.725 [18.42]	.620 [15.75]	.513 [13.03]	.520 [13.21]	.450 [11.43]	.425 [10.80]
51	.900 [22.86]	.795 [20.19]	.688 [17.48]	.695 [17.65]	.625 [15.88]	.600 [15.24]
65	1.075 [27.31]	.970 [24.64]	.863 [21.92]	.870 [22.10]	.800 [20.32]	.775 [19.69]

DIMENSIONS IN [] ARE IN MILLIMETERS AND ARE FOR REFERENCE ONLY

DUAL ROW LATCHING BI-LOBE® (TYPE WD)

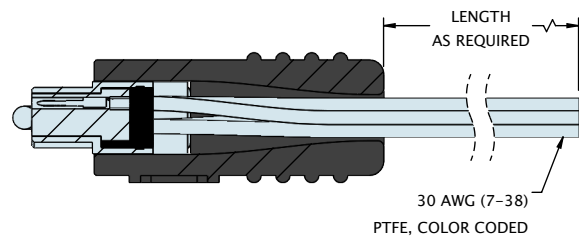
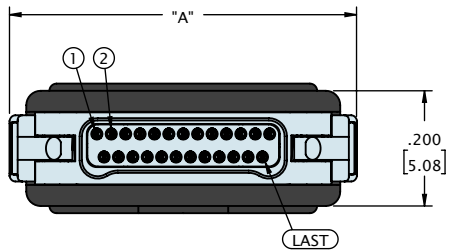
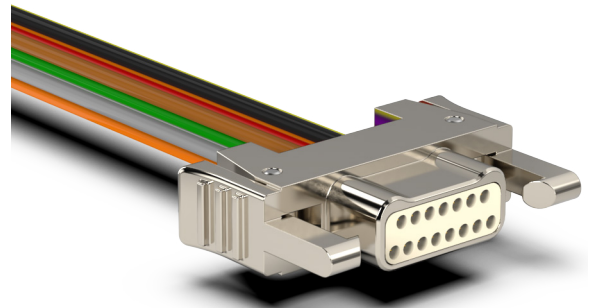
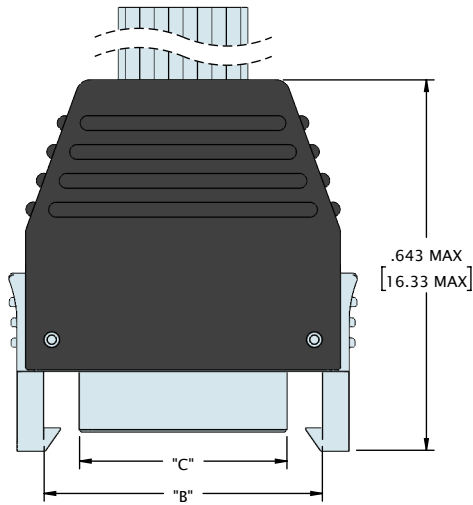

CONTACTS	"A"	"B"	"C"
09	.403 [10.25]	.283 [7.19]	.160 [4.06]
15	.478 [12.15]	.358 [9.09]	.235 [5.97]
21	.553 [14.06]	.433 [11.00]	.310 [7.87]
25	.603 [15.33]	.483 [12.27]	.360 [9.14]
31	.678 [17.23]	.558 [14.17]	.435 [11.05]
37	.753 [19.14]	.633 [16.08]	.510 [12.95]
51	.928 [23.58]	.808 [20.52]	.685 [17.40]
65	1.103 [28.03]	.983 [24.97]	.860 [21.84]

DIMENSIONS IN [] ARE IN MILLIMETERS AND ARE FOR REFERENCE ONLY

DUAL ROW LATCHING BI-LOBE® (TYPE WD)

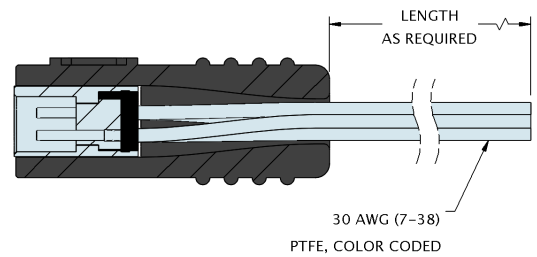
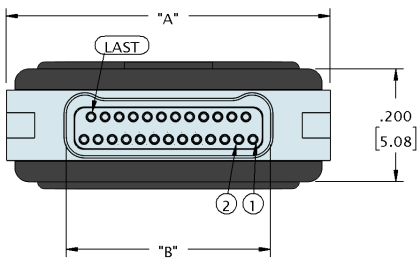
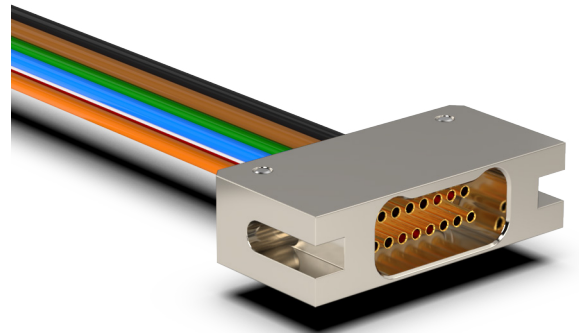
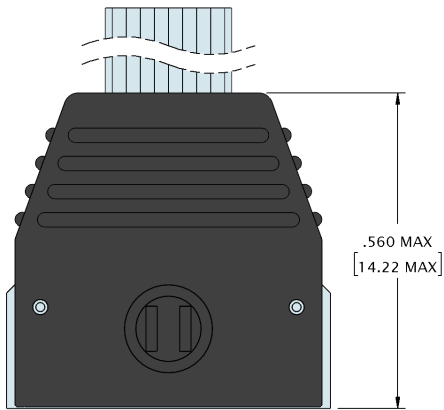
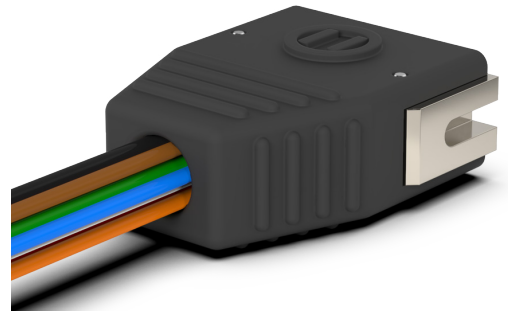

CONTACTS	"A"	"B"
09	.375 [9.53]	.163 [4.14]
15	.450 [11.43]	.238 [6.05]
21	.525 [13.34]	.313 [7.95]
25	.575 [14.61]	.363 [9.22]
31	.650 [16.51]	.438 [11.13]
37	.725 [18.42]	.513 [13.03]
51	.900 [22.86]	.688 [17.48]
65	1.075 [27.31]	.863 [21.92]

DIMENSIONS IN [] ARE IN MILLIMETERS AND ARE FOR REFERENCE ONLY

DUAL ROW LATCHING BI-LOBE® (TYPE WD)

PANEL MOUNT

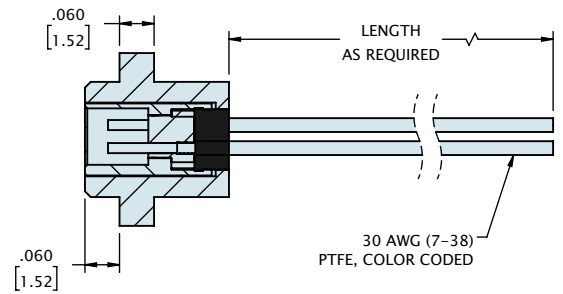
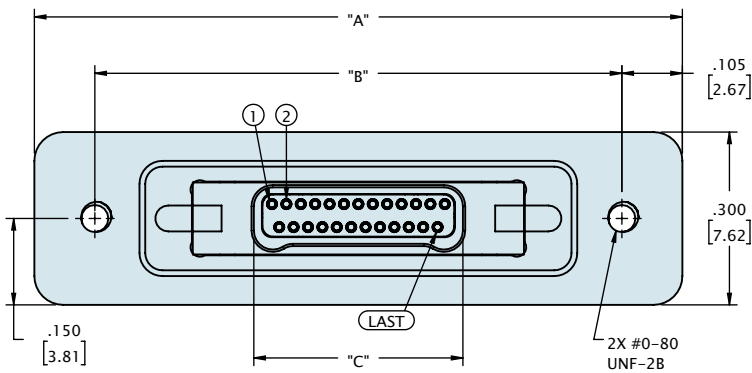
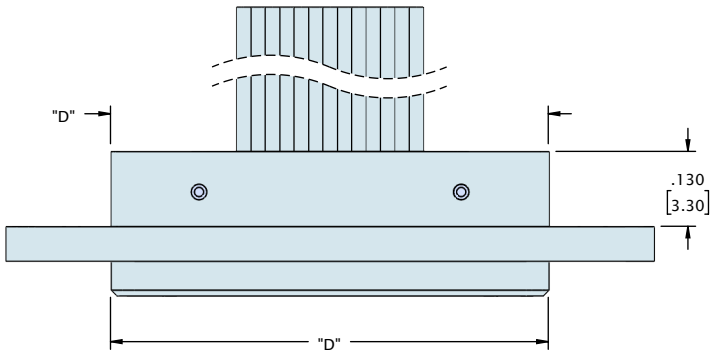
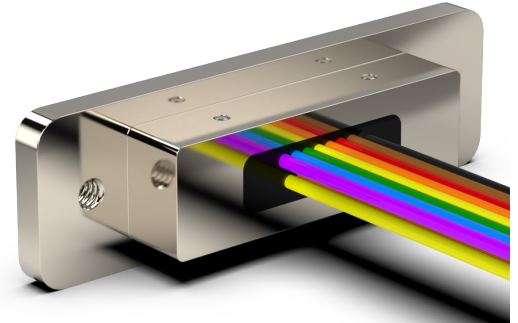
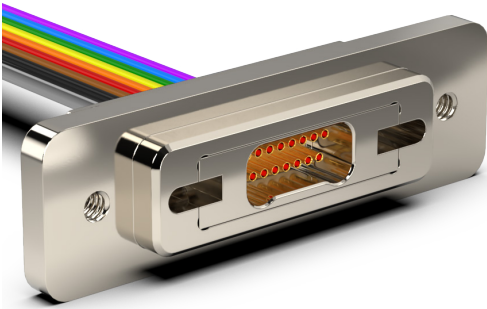

CONTACTS	"A"	"B"	"C"	"D"
09	.925 [23.50]	.715 [18.16]	.163 [4.14]	.560 [14.22]
15	1.000 [25.40]	.790 [20.07]	.238 [6.05]	.635 [16.13]
21	1.075 [27.31]	.865 [21.97]	.313 [7.95]	.710 [18.03]
25	1.125 [28.58]	.915 [23.24]	.363 [9.22]	.760 [19.30]
31	1.200 [30.48]	.990 [25.15]	.438 [11.13]	.835 [21.21]
37	1.275 [32.39]	1.065 [27.05]	.513 [13.03]	.910 [23.11]
51	1.450 [36.83]	1.240 [31.50]	.688 [17.48]	1.085 [27.56]
65	1.625 [41.28]	1.415 [35.94]	.863 [21.92]	1.260 [32.00]

DIMENSIONS IN [] ARE IN MILLIMETERS AND ARE FOR REFERENCE ONLY

ORDERING GUIDE

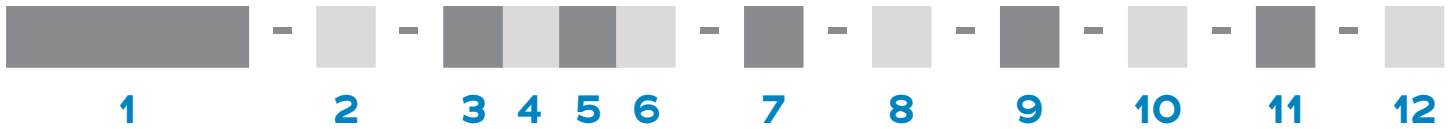

1 Series	MNPL Metal Nano Pin Latch MNSLP Metal Nano Socket Latch Panel	MNSL Metal Nano Socket Latch
2 Number Of Contacts	09 15 21 25 31 37 51 65	
3 Termination Type	AA Horizontal Surface Mount H4 Horizontal Thru-Hole	DD Thru-Hole Straight WD Discrete Wires FF Flex Tail
4 Wire Gage*	0 30 AWG (STD)	2 32 AWG
5 Wire Type*	Q NEMA HP3 (formerly M16878/4 and /6)	XX.X M22759/33 (30 AWG only)
6 Wire Length*	18.0 18.00" (STD)	XX.X Custom Length
7 Color Scheme*	C 10 Repeating Colors Per MIL STD 681	Y All Other Wire Colors
8 Shell Material & Finish	N Aluminum Shell, Electroless Nickel Plated B Aluminium Shell, Black Anodized T Titanium Shell, Unplated	CD Aluminium shell, Cadmium Plated S Stainless steel Shell, Passivated
9 Common Options	SR Strain Relief ** YY Non Standard Hardware (threaded holes, thumb screws, #2-56 screw) HT High Temp. Epoxy BS1 Standard Straight Backshell BS3 90/RA Oval BSY Custom Backshell	RH RoHS Compliant BS2 45 Oval BS4 2 Piece BS CS Customer Supplied Material
10 Shield / Jacket*	D Slip-on Braid E Machine Braid F Flexo Braid J Nomex Braid ST Shrink Tube	
11 Mod Codes	M10 Custom Keying M53 Space Grade Nano-D, SPT2	M50 Space Grade Nano-D, SPT1
12 Special Instructions	YYY Describe anything that is not covered in standard options	

* WD only

** MNPL & MNSL only

SINGLE ROW HORIZONTAL SMT (TYPE AA)

Omnetics' **Single Row Horizontal SMT Bi-Lobe®** connectors feature an extremely low-profile package size, making them well-suited for pick-and-place assembly processes. These durable, lightweight connectors feature Omnetics' gold-plated Flex Pin contact system and deliver reliable connectivity in rugged environments. They are spaced on .025" (.64 mm) centerlines and can carry 1 amp per contact. These connectors are available in standard sizes ranging from 5 to 51 positions, as well as custom configurations.



Electro-Mechanical Specifications

TYPE	PERFORMANCE
Durability	> 2000 Mating Cycles min
Temperature	-55°C to +125 °C (200 °C w/HTE)
Current rating	1 Amp per contact
Voltage Rating (DWV)	250 VAC RMS Sea Level
Insulation Resistance	5,000 Megohms @ 100 VDC
Shock	100 g's discontinuity < 10 nanoseconds
Vibration	20 g's discontinuity < 10 nanoseconds
Thermal Vacuum Outgassing	1.0% max TML, 0.1% VCM
Contact Resistance	87 milliohms (87 mV) max @ 1 Amp
Mating/Unmating Force	2.5 oz. (.71g) typical per contact

Material Specifications

TYPE	PERFORMANCE
Contact	Copper Alloy Per MIL-DTL-32139
Contact Finish	Gold per ASTM B488, Type II, Class 1.27, Code C Over Nickel Underplate
Insulator	LCP Per MIL-DTL-32139 Or PEEK
Encapsulant	Epoxy

Shell Options

TYPE	PERFORMANCE
Aluminum 6061	Electroless Nickel per SAE-AMS-2404
Stainless Steel, 300 Series	Passivated per SAE-AMS-2700

SINGLE ROW HORIZONTAL SMT (TYPE AA)

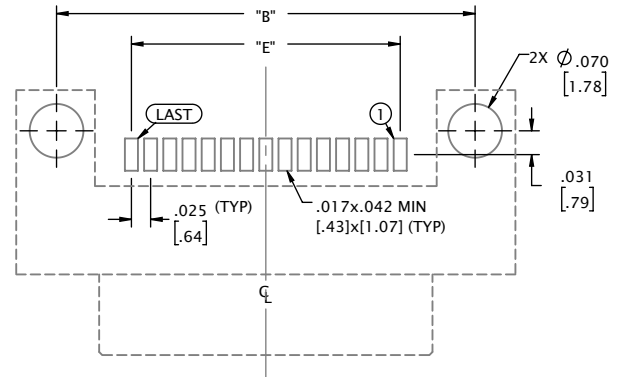
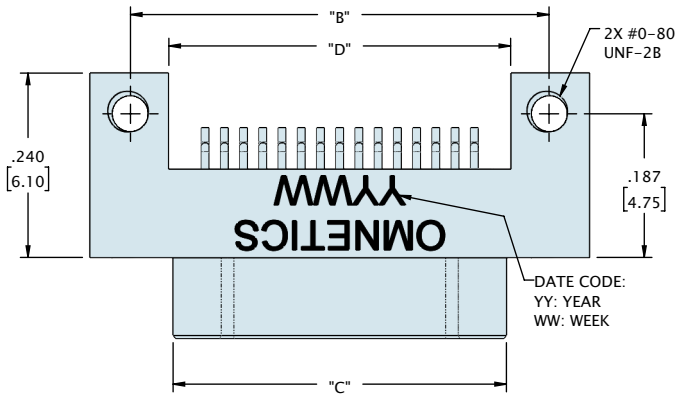
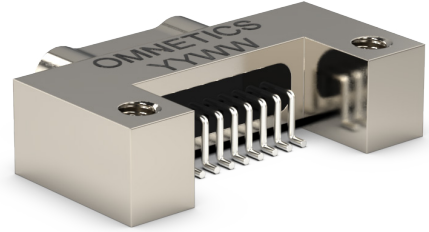
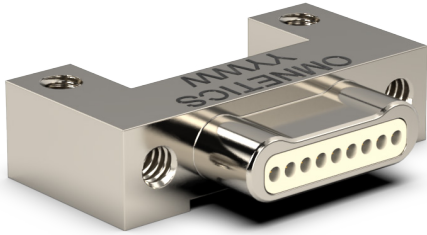

**SUGGESTED PAD LAYOUT
(VIEW FROM MOUNTING SIDE OF BOARD)**

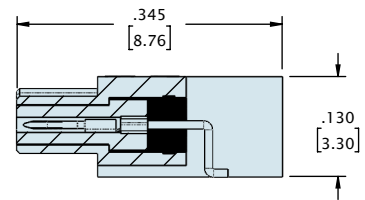
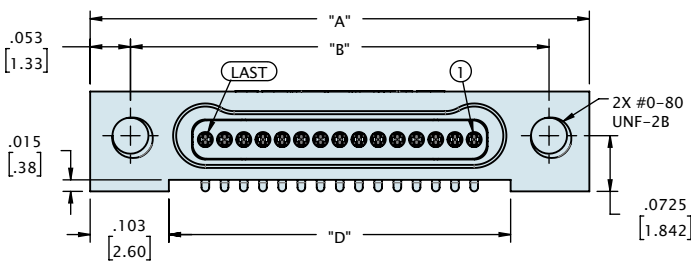

CONTACTS	"A"	"B"	"C"	"D"	"E"
05	.400 [10.16]	.295 [7.49]	.184 [4.67]	.195 [4.95]	.100 [2.54]
09	.500 [12.70]	.395 [10.03]	.284 [7.21]	.295 [7.49]	.200 [5.08]
15	.650 [16.51]	.545 [13.84]	.434 [11.02]	.445 [11.30]	.350 [8.89]
21	.800 [20.32]	.695 [17.65]	.584 [14.83]	.595 [15.11]	.500 [12.70]
25	.900 [22.86]	.795 [20.19]	.684 [17.37]	.695 [17.65]	.600 [15.24]
31	1.050 [26.67]	.945 [24.00]	.834 [21.18]	.845 [21.46]	.750 [19.05]
37	1.200 [30.48]	1.095 [27.81]	.984 [24.99]	.995 [25.27]	.900 [22.86]
51	1.550 [39.37]	1.445 [36.70]	1.334 [33.88]	1.345 [34.16]	1.250 [31.75]

DIMENSIONS IN [] ARE IN MILLIMETERS AND ARE FOR REFERENCE ONLY

SINGLE ROW HORIZONTAL SMT (TYPE AA)

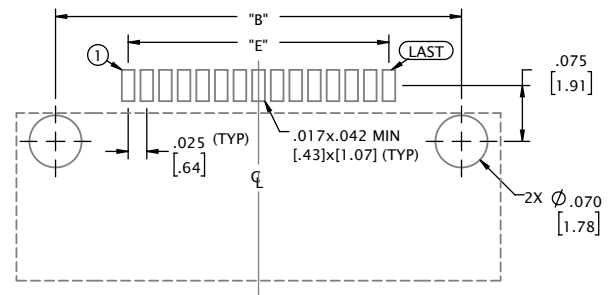
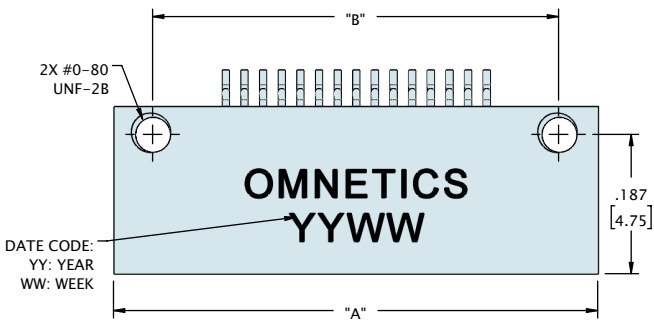
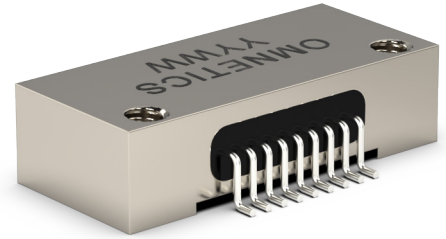

SUGGESTED PAD LAYOUT
(VIEW FROM MOUNTING SIDE OF BOARD)

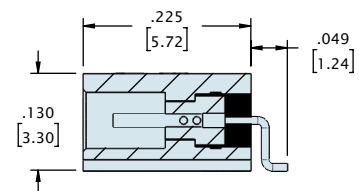
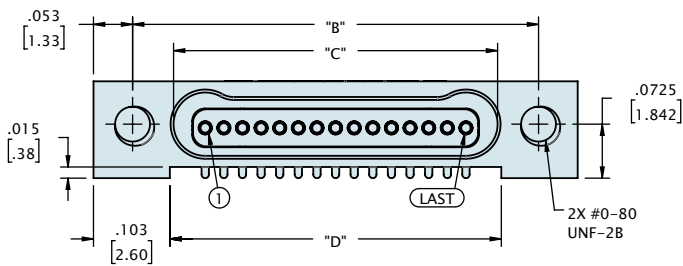

CONTACTS	"A"	"B"	"C"	"D"	"E"
05	.400 [10.16]	.295 [7.49]	.185 [4.70]	.195 [4.95]	.100 [2.54]
09	.500 [12.70]	.395 [10.03]	.285 [7.24]	.295 [7.49]	.200 [5.08]
15	.650 [16.51]	.545 [13.84]	.435 [11.05]	.445 [11.30]	.350 [8.89]
21	.800 [20.32]	.695 [17.65]	.585 [14.86]	.595 [15.11]	.500 [12.70]
25	.900 [22.86]	.795 [20.19]	.685 [17.40]	.695 [17.65]	.600 [15.24]
31	1.050 [26.67]	.945 [24.00]	.835 [21.21]	.845 [21.46]	.750 [19.05]
37	1.200 [30.48]	1.095 [27.81]	.985 [25.02]	.995 [25.27]	.900 [22.86]
51	1.550 [39.37]	1.445 [36.70]	1.335 [33.91]	1.345 [34.16]	1.250 [31.75]

DIMENSIONS IN [] ARE IN MILLIMETERS AND ARE FOR REFERENCE ONLY

ORDERING GUIDE

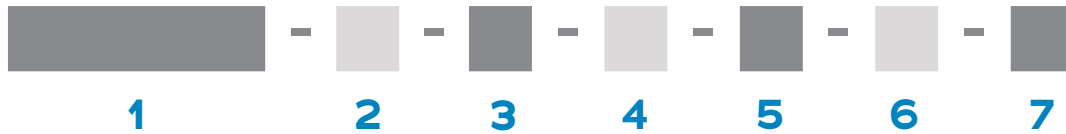

1 Series	MBPS Metal Bi-Lobe Pin Single-Row	MBSS Metal Bi-Lobe Socket Single-Row
2 Number Of Contacts	O5 O9 15 21 25 31 37 51	
3 Termination Type	AA Horizontal Surface Mount	
4 Shell Material & Finish	N Aluminum Shell, Electroless Nickel Plated B Aluminium Shell, Black Anodized T Titanium Shell, Unplated	CD Aluminium shell, Cadmium Plated S Stainless steel Shell, Passivated
5 Common Options	ETH End Threaded Hole, #0-80 NTH Non-Threaded Holes for mounting to the board YY Non Standard Hardware (threaded holes, thumb screws, #2-56 screw) HT High Temp. Epoxy CS Customer Supplied Material	
6 Mod Codes	M10 Custom Keying M53 Space Grade Nano-D, SPT2	M50 Space Grade Nano-D, SPT1
7 Special Instructions	YYY Describe anything that is not covered in standard options	

SINGLE ROW VERTICAL SMT (TYPE VV)

Vertical SMT Bi-Lobe[®] connectors require minimal board space on flex circuits and printed circuit boards, making them an ideal choice for space-constrained applications that operate in rugged environmental conditions. These connectors feature Omnetics' highly reliable gold-plated Flex Pin contact system and are available with threaded mounting holes and retention screws. They are available in a wide range of configurations to meet the needs of a variety of critical applications. Choose from shell materials including titanium, aluminum, and stainless steel, with multiple options for plating materials. These connectors are available in standard sizes ranging from 5 through 51 positions, as well as custom configurations.

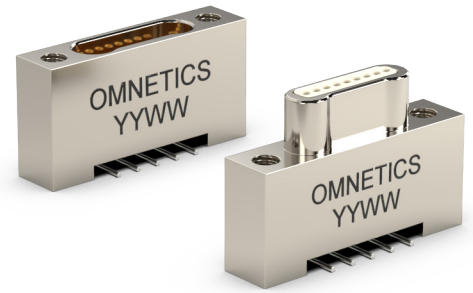

Electro-Mechanical Specifications

TYPE	PERFORMANCE
Durability	> 2000 Mating Cycles min
Temperature	-55°C to +125 °C (200 °C w/HTE)
Current rating	1 Amp per contact
Voltage Rating (DWV)	250 VAC RMS Sea Level
Insulation Resistance	5,000 Megohms @ 100 VDC
Shock	100 g's discontinuity < 10 nanoseconds
Vibration	20 g's discontinuity < 10 nanoseconds
Thermal Vacuum Outgassing	1.0% max TML, 0.1% VCM
Contact Resistance	87 milliohms (87 mV) max @ 1 Amp
Mating/Unmating Force	2.5 oz. (.71g) typical per contact

Material Specifications

TYPE	PERFORMANCE
Contact	Copper Alloy Per MIL-DTL-32139
Contact Finish	Gold per ASTM B488, Type II, Class 1.27, Code C Over Nickel Underplate
Insulator	LCP Per MIL-DTL-32139 Or PEEK
Encapsulant	Epoxy

Shell Options

TYPE	PERFORMANCE
Aluminum 6061	Electroless Nickel per SAE-AMS-2404
Stainless Steel, 300 Series	Passivated per SAE-AMS-2700

SINGLE ROW VERTICAL SMT (TYPE VV)

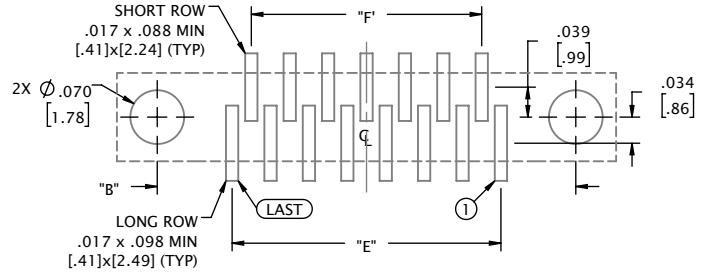
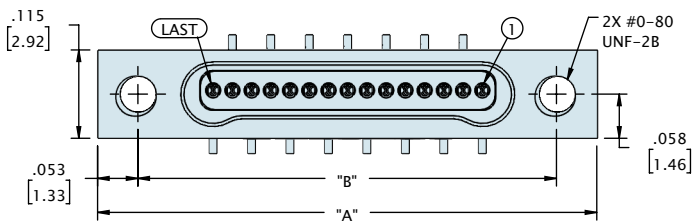
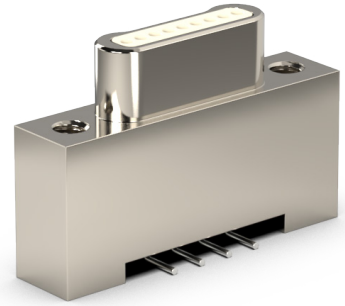
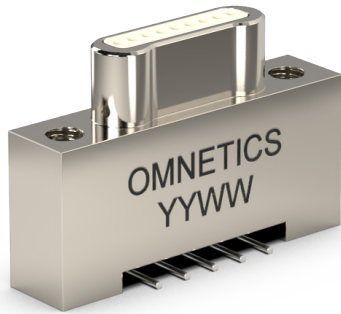

SUGGESTED PAD LAYOUT
(VIEW FROM MOUNTING SIDE OF BOARD)

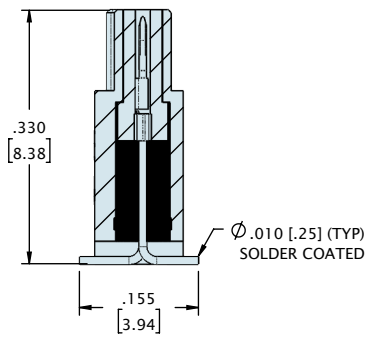
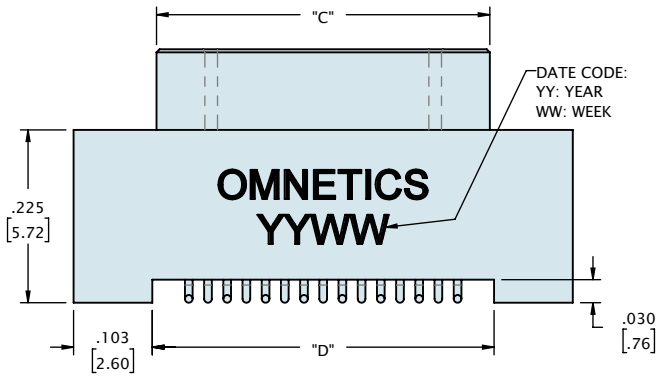

CONTACTS	"A"	"B"	"C"	"D"	"E"	"F"
05	.400 [10.16]	.295 [7.49]	.206 [5.23]	.195 [4.95]	.100 [2.54]	.050 [1.27]
09	.500 [12.70]	.395 [10.03]	.306 [7.77]	.295 [7.49]	.200 [5.08]	.150 [3.81]
15	.650 [16.51]	.545 [13.84]	.456 [11.58]	.445 [11.30]	.350 [8.89]	.300 [7.62]
21	.800 [20.32]	.695 [17.65]	.606 [15.39]	.595 [15.11]	.500 [12.70]	.450 [11.43]
25	.900 [22.86]	.795 [20.19]	.706 [17.93]	.695 [17.65]	.600 [15.24]	.550 [13.97]
31	1.050 [26.67]	.945 [24.00]	.856 [21.74]	.845 [21.46]	.750 [19.05]	.700 [17.78]
37	1.200 [30.48]	1.095 [27.81]	1.006 [25.55]	.995 [25.27]	.900 [22.86]	.850 [21.59]
51	1.550 [39.37]	1.445 [36.70]	1.356 [34.44]	1.345 [34.16]	1.250 [31.75]	1.200 [30.48]

DIMENSIONS IN [] ARE IN MILLIMETERS AND ARE FOR REFERENCE ONLY

SINGLE ROW VERTICAL SMT (TYPE VV)

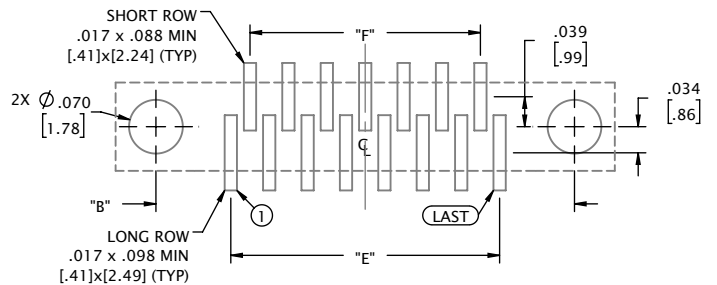
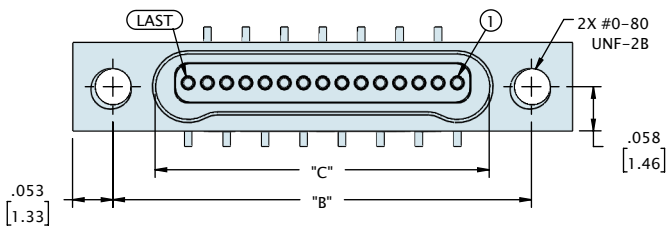

SUGGESTED PAD LAYOUT
(VIEW FROM MOUNTING SIDE OF BOARD)

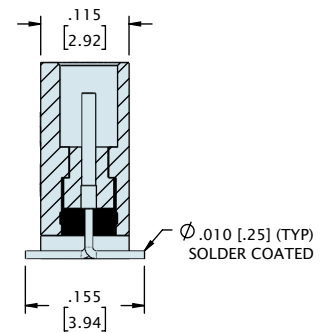
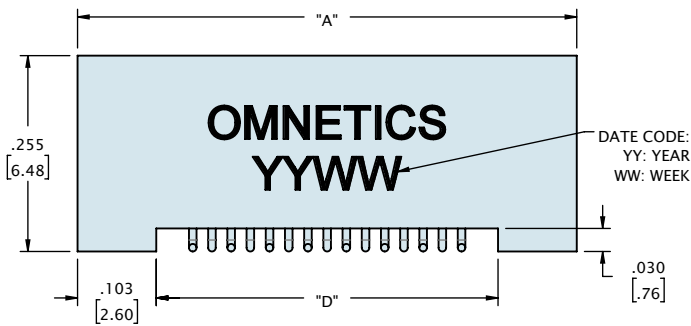

CONTACTS	"A"	"B"	"C"	"D"	"E"	"F"
05	.400 [10.16]	.295 [7.49]	.185 [4.70]	.195 [4.95]	.100 [2.54]	.050 [1.27]
09	.500 [12.70]	.395 [10.03]	.285 [7.24]	.295 [7.49]	.200 [5.08]	.150 [3.81]
15	.650 [16.51]	.545 [13.84]	.435 [11.05]	.445 [11.30]	.350 [8.89]	.300 [7.62]
21	.800 [20.32]	.695 [17.65]	.585 [14.86]	.595 [15.11]	.500 [12.70]	.450 [11.43]
25	.900 [22.86]	.795 [20.19]	.685 [17.40]	.695 [17.65]	.600 [15.24]	.550 [13.97]
31	1.050 [26.67]	.945 [24.00]	.835 [21.21]	.845 [21.46]	.750 [19.05]	.700 [17.78]
37	1.200 [30.48]	1.095 [27.81]	.985 [25.02]	.995 [25.27]	.900 [22.86]	.850 [21.59]
51	1.550 [39.37]	1.445 [36.70]	1.335 [33.91]	1.345 [34.16]	1.250 [31.75]	1.200 [30.48]

DIMENSIONS IN [] ARE IN MILLIMETERS AND ARE FOR REFERENCE ONLY

ORDERING GUIDE

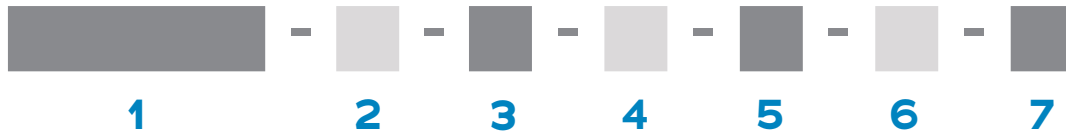

1 Series	MBPS Metal Bi-Lobe Pin Single-Row	MBSS Metal Bi-Lobe Socket Single-Row
2 Number Of Contacts	05 09 15 21 25 31 37 51	
3 Termination Type	VV Vertical Surface Mount	
4 Shell Material & Finish	N Aluminium Shell, Electroless Nickel Plated B Aluminium Shell, Black Anodized T Titanium Shell, Unplated	CD Aluminium shell, Cadmium Plated S Stainless steel Shell, Passivated
5 Common Options	ETH End Threaded Hole, #0-80 NTH Non-Threaded Holes For Mounting To The Board YY Non Standard Hardware (threaded holes, thumb screws, #2-56 screw) HT High Temp. Epoxy CS Customer Supplied Material	
6 Mod Codes	M10 Custom Keying M53 Space Grade Nano-D, SPT2	M50 Space Grade Nano-D, SPT1
7 Special Instructions	YYY Describe anything that is not covered in standard options	

SINGLE ROW STRAIGHT TAIL (TYPE DD)

The **Single Row Bi-Lobe®** nanos are suitable for high-reliability electronic devices in medical, military, and other demanding environments. They are a thru-hole mounted, low-mass ruggedized connector on .025" (.64 mm) centerlines. The thru-hole tails are spread onto a mounting pattern on .050 (1.27 mm) with space for annular rings and routing traces. They feature Omnetics' gold-plated Flex Pin contact system. These durable, lightweight connectors intermate with Omnetics QPL versions of MIL-DTL-32139. They are available with retention screws for a positive lock and come in standard sizes ranging from 5 to 51 positions. Custom configurations are also available.



Electro-Mechanical Specifications

TYPE	PERFORMANCE
Durability	> 2000 Mating Cycles min
Temperature	-55°C to +125 °C (200 °C w/HTE)
Current rating	1 Amp per contact
Voltage Rating (DWV)	250 VAC RMS Sea Level
Insulation Resistance	5,000 Megohms @ 100 VDC
Shock	100 g's discontinuity < 10 nanoseconds
Vibration	20 g's discontinuity < 10 nanoseconds
Thermal Vacuum Outgassing	1.0% max TML, 0.1% VCM
Contact Resistance	71 milliohms (71 mV) max @ 1 Amp
Mating/Unmating Force	2.5 oz. (.71g) typical per contact

Material Specifications

TYPE	PERFORMANCE
Contact	Copper Alloy Per MIL-DTL-32139
Contact Finish	Gold per ASTM B488, Type II, Class 1.27, Code C Over Nickel Underplate
Insulator	LCP Per MIL-DTL-32139 Or PEEK
Encapsulant	Epoxy

Shell Options

TYPE	PERFORMANCE
Aluminum 6061	Electroless Nickel per SAE-AMS-2404
Stainless Steel, 300 Series	Passivated per SAE-AMS-2700

SINGLE ROW STRAIGHT TAIL (TYPE DD)

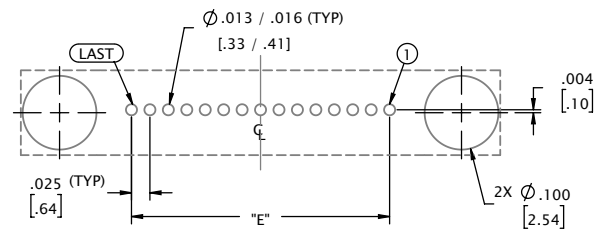
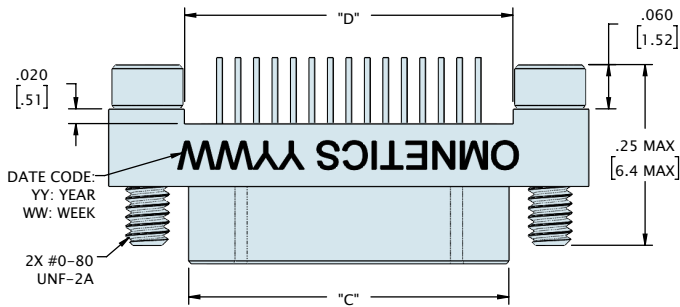
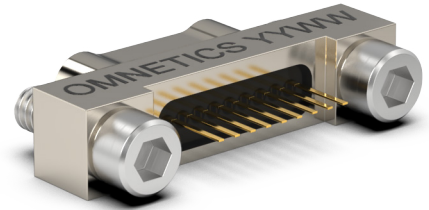

SUGGESTED PAD LAYOUT
(VIEW FROM MOUNTING SIDE OF BOARD)

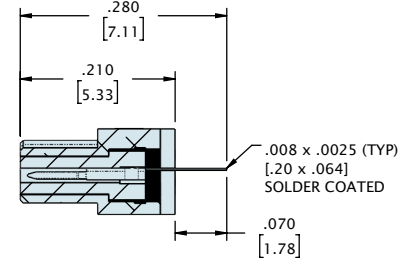
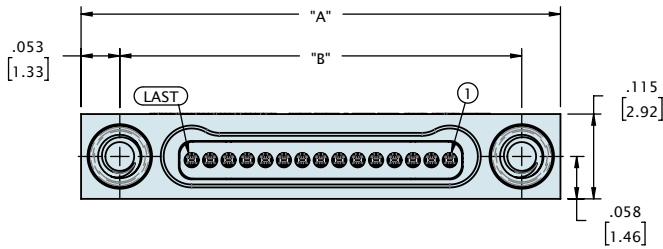

JACKSCREW NOT SHOWN FOR CLARITY

CONTACTS	"A"	"B"	"C"	"D"	"E"
05	.400 [10.16]	.295 [7.49]	.184 [4.67]	.195 [4.95]	.100 [2.54]
09	.500 [12.70]	.395 [10.03]	.284 [7.21]	.295 [7.49]	.200 [5.08]
15	.650 [16.51]	.545 [13.84]	.434 [11.02]	.445 [11.30]	.350 [8.89]
21	.800 [20.32]	.695 [17.65]	.584 [14.83]	.595 [15.11]	.500 [12.70]
25	.900 [22.86]	.795 [20.19]	.684 [17.37]	.695 [17.65]	.600 [15.24]
31	1.050 [26.67]	.945 [24.00]	.834 [21.18]	.845 [21.46]	.750 [19.05]
37	1.200 [30.48]	1.095 [27.81]	.984 [24.99]	.995 [25.27]	.900 [22.86]
51	1.550 [39.37]	1.445 [36.70]	1.334 [33.88]	1.345 [34.16]	1.250 [31.75]

DIMENSIONS IN [] ARE IN MILLIMETERS AND ARE FOR REFERENCE ONLY

SINGLE ROW STRAIGHT TAIL (TYPE DD)

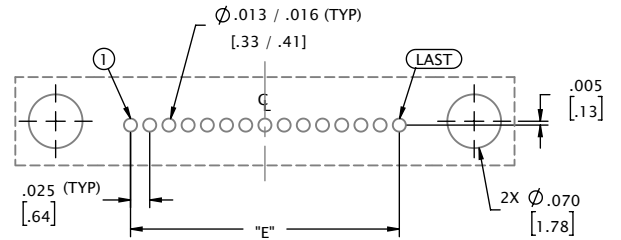
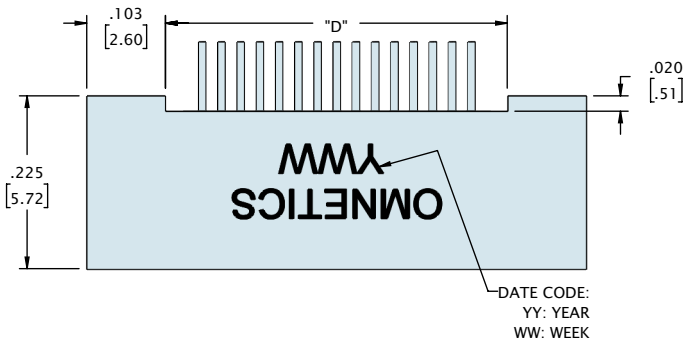
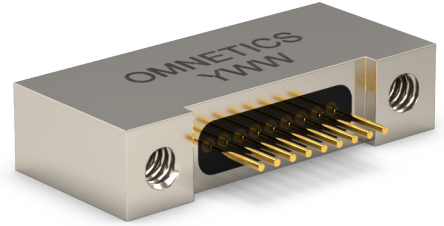

SUGGESTED PAD LAYOUT
(VIEW FROM MOUNTING SIDE OF BOARD)

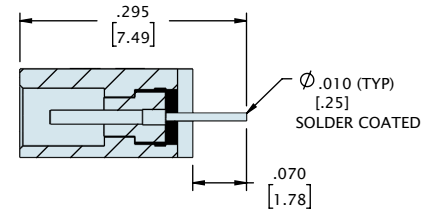
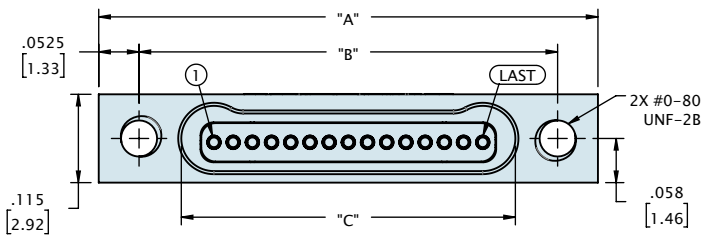

CONTACTS	"A"	"B"	"C"	"D"	"E"
05	.400 [10.16]	.295 [7.49]	.185 [4.70]	.195 [4.95]	.100 [2.54]
09	.500 [12.70]	.395 [10.03]	.285 [7.24]	.295 [7.49]	.200 [5.08]
15	.650 [16.51]	.545 [13.84]	.435 [11.05]	.445 [11.30]	.350 [8.89]
21	.800 [20.32]	.695 [17.65]	.585 [14.86]	.595 [15.11]	.500 [12.70]
25	.900 [22.86]	.795 [20.19]	.685 [17.40]	.695 [17.65]	.600 [15.24]
31	1.050 [26.67]	.945 [24.00]	.835 [21.21]	.845 [21.46]	.750 [19.05]
37	1.200 [30.48]	1.095 [27.81]	.985 [25.02]	.995 [25.27]	.900 [22.86]
51	1.550 [39.37]	1.445 [36.70]	1.355 [34.42]	1.345 [34.16]	1.250 [31.75]

DIMENSIONS IN [] ARE IN MILLIMETERS AND ARE FOR REFERENCE ONLY

ORDERING GUIDE

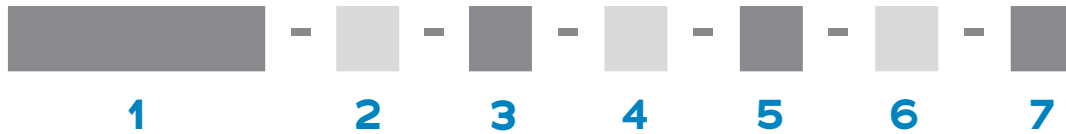

1 Series	MBPS Metal Bi-Lobe Pin Single-Row	MBSS Metal Bi-Lobe Socket Single-Row
2 Number Of Contacts	05 09 15 21 25 31 37 51	
3 Termination Type	DD Thru-Hole Straight	
4 Shell Material & Finish	N Aluminum Shell, Electroless Nickel Plated B Aluminium Shell, Black Anodized T Titanium Shell, Unplated	CD Aluminium shell, Cadmium Plated S Stainless steel Shell, Passivated
5 Common Options	ETH End Threaded Hole, #0-80 NTH Non-Threaded Holes for mounting to the board YY Non Standard Hardware (threaded holes, thumb screws, #2-56 screw) HT High Temp. Epoxy CS Customer Supplied Material	
6 Mod Codes	M10 Custom Keying M53 Space Grade Nano-D, SPT2	M50 Space Grade Nano-D, SPT1
7 Special Instructions	YYY Describe anything that is not covered in standard options	

SINGLE ROW HORIZONTAL THRU-HOLE (TYPE H2)

The **Single Row Bi-Lobe®** H2 nanos are suitable for high-reliability electronic devices in medical, military, and other demanding environments. They are a thru-hole mounted, low-mass ruggedized connector on .025" (.64 mm) centerlines. The thru-hole tails are spread onto a mounting pattern on .050 (1.27 mm) with space for annular rings and routing traces. They feature Omnetics' gold-plated Flex Pin contact system. These durable, lightweight connectors intermate with Omnetics QPL versions of MIL-DTL-32139. They are available with retention screws for a positive lock and come in standard sizes ranging from 5 to 51 positions. Custom configurations are also available.

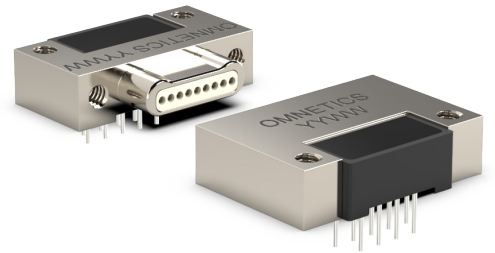

Electro-Mechanical Specifications

TYPE	PERFORMANCE
Durability	> 2000 Mating Cycles min
Temperature	-55°C to +125 °C (200 °C w/HTE)
Current rating	1 Amp per contact
Voltage Rating (DWV)	250 VAC RMS Sea Level
Insulation Resistance	5,000 Megohms @ 100 VDC
Shock	100 g's discontinuity < 10 nanoseconds
Vibration	20 g's discontinuity < 10 nanoseconds
Thermal Vacuum Outgassing	1.0% max TML, 0.1% VCM
Contact Resistance	87 milliohms (87 mV) max @ 1 Amp
Mating/Unmating Force	2.5 oz. (.71g) typical per contact

Material Specifications

TYPE	PERFORMANCE
Contact	Copper Alloy Per MIL-DTL-32139
Contact Finish	Gold per ASTM B488, Type II, Class 1.27, Code C Over Nickel Underplate
Insulator	LCP Per MIL-DTL-32139 Or PEEK
Encapsulant	Epoxy

Shell Options

TYPE	PERFORMANCE
Aluminum 6061	Electroless Nickel per SAE-AMS-2404
Stainless Steel, 300 Series	Passivated per SAE-AMS-2700

SINGLE ROW HORIZONTAL THRU-HOLE (TYPE H2)

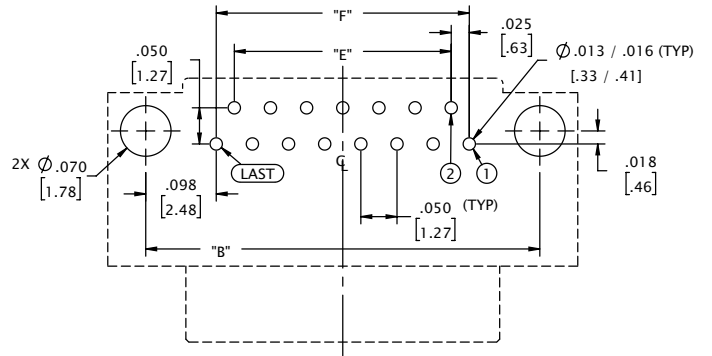
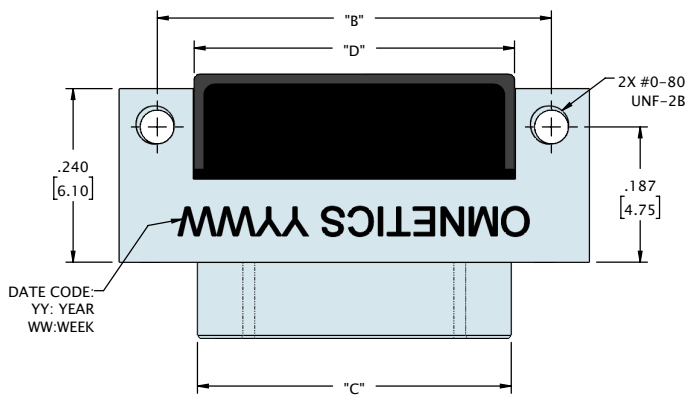
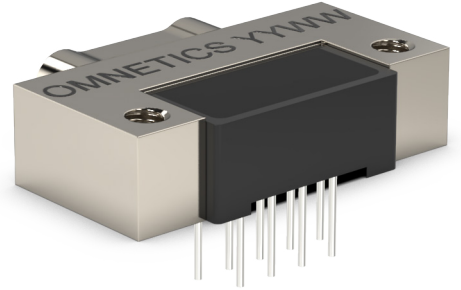
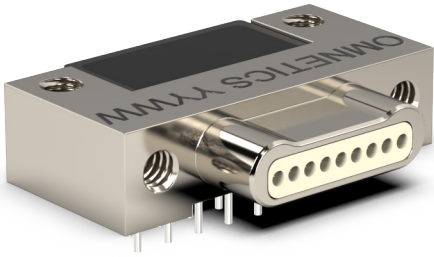

SUGGESTED PAD LAYOUT
(VIEW FROM MOUNTING SIDE OF BOARD)

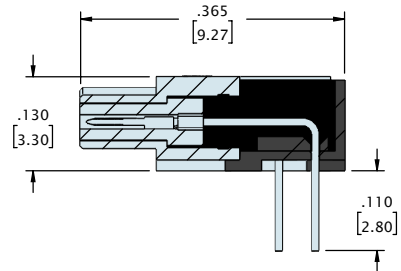
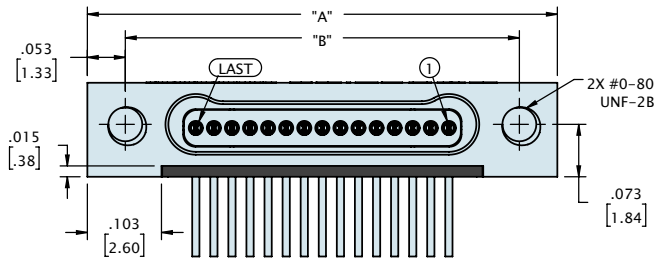

CONTACTS	"A"	"B"	"C"	"D"	"E"	"F"
05	.400 [10.16]	.295 [7.49]	.184 [4.67]	.193 [4.90]	.050 [1.27]	.100 [2.54]
09	.500 [12.70]	.395 [10.03]	.284 [7.21]	.293 [7.44]	.150 [3.81]	.200 [5.08]
15	.650 [16.51]	.545 [13.84]	.434 [11.02]	.443 [11.25]	.300 [7.62]	.350 [8.89]
21	.800 [20.32]	.695 [17.65]	.584 [14.83]	.593 [15.06]	.450 [11.43]	.500 [12.70]
25	.900 [22.86]	.795 [20.19]	.684 [17.37]	.693 [17.60]	.550 [13.97]	.600 [15.24]
31	1.050 [26.67]	.945 [24.00]	.834 [21.18]	.843 [21.41]	.700 [17.78]	.750 [19.05]
37	1.200 [30.48]	1.095 [27.81]	.984 [24.99]	.993 [25.22]	.850 [21.59]	.900 [22.86]
51	1.550 [39.37]	1.445 [36.70]	1.334 [33.88]	1.343 [34.11]	1.200 [30.48]	1.250 [31.75]

DIMENSIONS IN [] ARE IN MILLIMETERS AND ARE FOR REFERENCE ONLY

SINGLE ROW HORIZONTAL THRU-HOLE (TYPE H2)

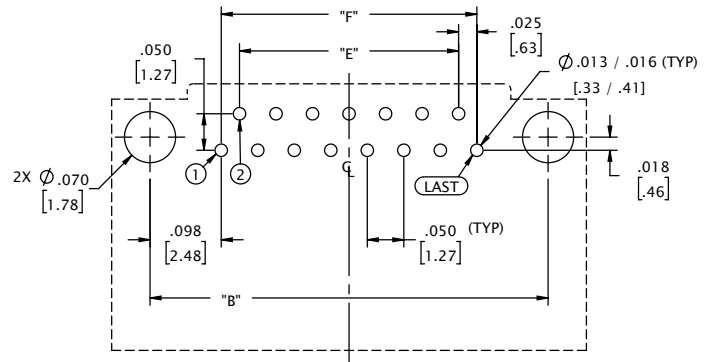
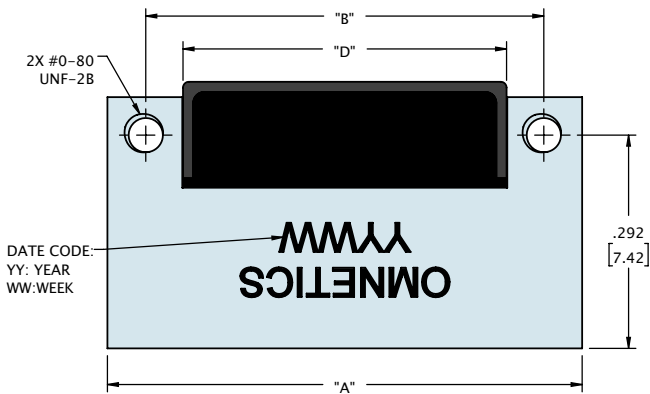
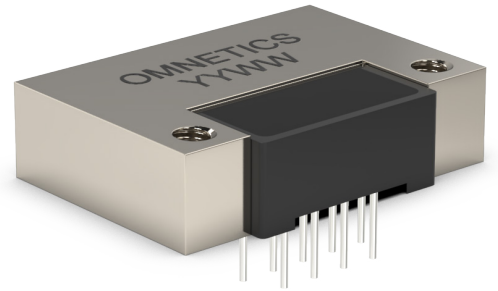

SUGGESTED PAD LAYOUT
(VIEW FROM MOUNTING SIDE OF BOARD)

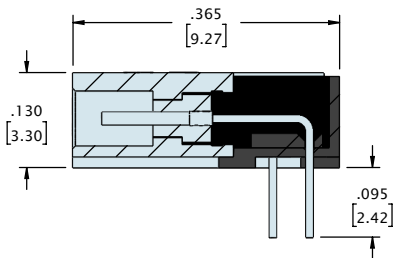
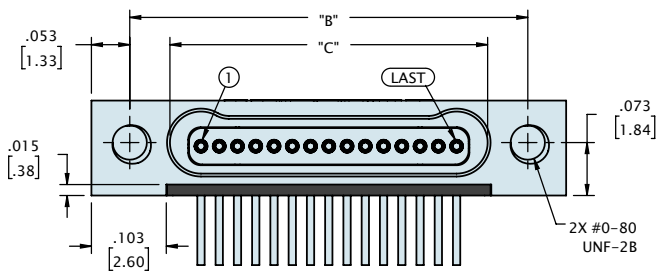

CONTACTS	"A"	"B"	"C"	"D"	"E"	"F"
05	.400 [10.16]	.295 [7.49]	.185 [4.70]	.193 [4.90]	.050 [1.27]	.100 [2.54]
09	.500 [12.70]	.395 [10.03]	.285 [7.24]	.293 [7.44]	.150 [3.81]	.200 [5.08]
15	.650 [16.51]	.545 [13.84]	.435 [11.05]	.443 [11.25]	.300 [7.62]	.350 [8.89]
21	.800 [20.32]	.695 [17.65]	.585 [14.86]	.593 [15.06]	.450 [11.43]	.500 [12.70]
25	.900 [22.86]	.795 [20.19]	.685 [17.40]	.693 [17.60]	.550 [13.97]	.600 [15.24]
31	1.050 [26.67]	.945 [24.00]	.835 [21.21]	.843 [21.41]	.700 [17.78]	.750 [19.05]
37	1.200 [30.48]	1.095 [27.81]	.985 [25.02]	.993 [25.22]	.850 [21.59]	.900 [22.86]
51	1.550 [39.37]	1.445 [36.70]	1.335 [33.91]	1.343 [34.11]	1.200 [30.48]	1.250 [31.75]

DIMENSIONS IN [] ARE IN MILLIMETERS AND ARE FOR REFERENCE ONLY

ORDERING GUIDE

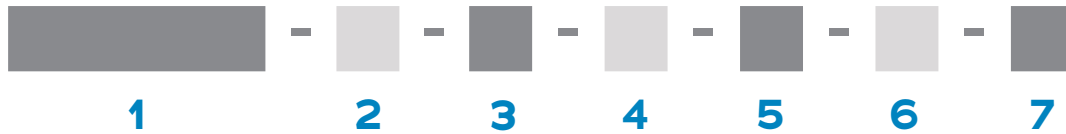

1 Series	MBPS Metal Bi-Lobe Pin Single-Row	MBSS Metal Bi-Lobe Socket Single-Row
2 Number Of Contacts	O5	O9 15 21 25 31 37 51
3 Termination Type	H2 Horizontal Thru-Hole	
4 Shell Material & Finish	N Aluminum Shell, Electroless Nickel Plated B Aluminium Shell, Black Anodized T Titanium Shell, Unplated	CD Aluminium shell, Cadmium Plated S Stainless steel Shell, Passivated
5 Common Options	ETH End Threaded Hole, #0-80 NTH Non-Threaded Holes For Mounting To The Board YY Non Standard Hardware (threaded holes, thumb screws, #2-56 screw) HT High Temp. Epoxy CS Customer Supplied Material	EJS End Jack Screw RH RoHS Compliant
6 Mod Codes	M10 Custom Keying M53 Space Grade Nano-D, SPT2	M50 Space Grade Nano-D, SPT1
7 Special Instructions	YYY Describe anything that is not covered in standard options	

SINGLE ROW VERTICAL THRU-HOLE (TYPE V2)

Applications that experience frequent high vibration and shock are served well by Omnetics' **Single Row Bi-Lobe® V2** nanos. This low-mass vertical thru-hole mounted connector has contacts arranged on .025" (.64 mm) centerlines. The thru-hole tails are spread onto a mounting pattern on .050 (1.27 mm) with space for annular rings and routing traces. They feature Omnetics' gold-plated Flex Pin contact system. These durable, lightweight connectors serve the most demanding applications and intermate with Omnetics QPL versions of MIL-DTL-32139. They are available with retention screws for a positive lock and come in standard sizes ranging from 5 to 51 positions. Custom configurations are also available.

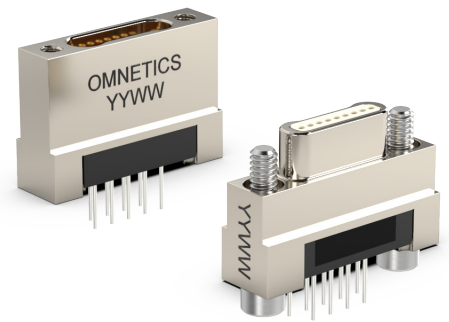

Electro-Mechanical Specifications

TYPE	PERFORMANCE
Durability	> 2000 Mating Cycles min
Temperature	-55°C to +125 °C (200 °C w/HTE)
Current rating	1 Amp per contact
Voltage Rating (DWV)	250 VAC RMS Sea Level
Insulation Resistance	5,000 Megohms @ 100 VDC
Shock	100 g's discontinuity < 10 nanoseconds
Vibration	20 g's discontinuity < 10 nanoseconds
Thermal Vacuum Outgassing	1.0% max TML, 0.1% VCM
Contact Resistance	87 milliohms (87 mV) max @ 1 Amp
Mating/Unmating Force	2.5 oz. (.71g) typical per contact

Material Specifications

TYPE	PERFORMANCE
Contact	Copper Alloy Per MIL-DTL-32139
Contact Finish	Gold per ASTM B488, Type II, Class 1.27, Code C Over Nickel Underplate
Insulator	LCP Per MIL-DTL-32139 Or PEEK
Encapsulant	Epoxy

Shell Options

TYPE	PERFORMANCE
Aluminum 6061	Electroless Nickel per SAE-AMS-2404
Stainless Steel, 300 Series	Passivated per SAE-AMS-2700

SINGLE ROW VERTICAL THRU-HOLE (TYPE V2)

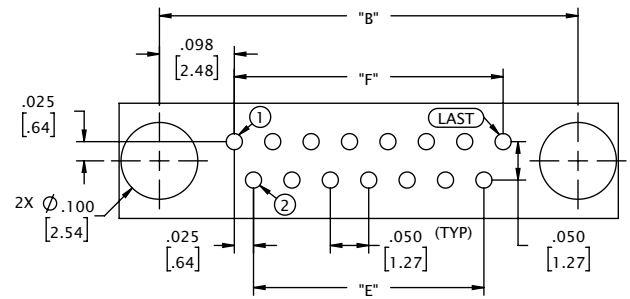
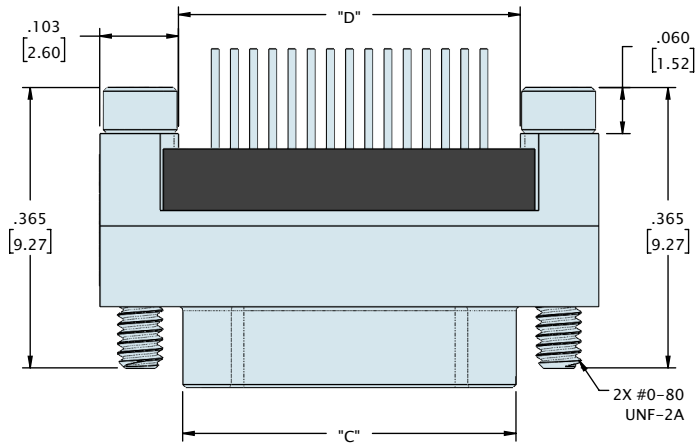
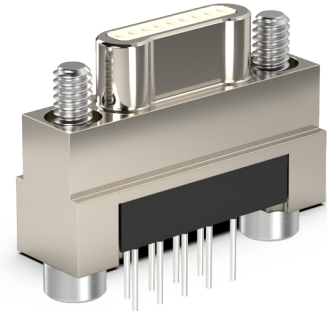
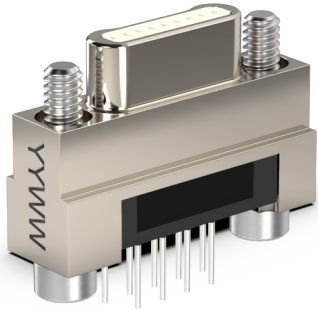

**SUGGESTED PAD LAYOUT
(VIEW FROM MOUNTING SIDE OF BOARD)**

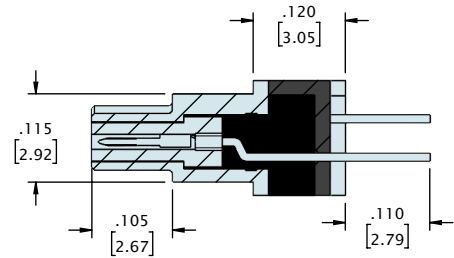
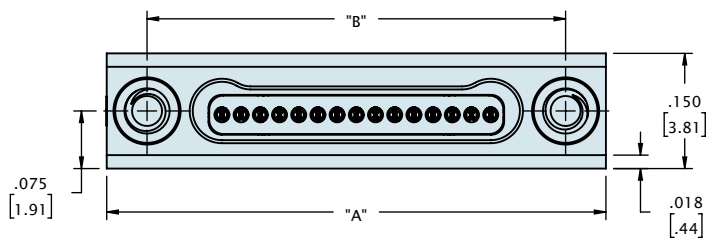

CONTACTS	"A"	"B"	"C"	"D"	"E"	"F"
05	.400 [10.16]	.295 [7.49]	.184 [4.67]	.195 [4.95]	.050 [1.27]	.100 [2.54]
09	.500 [12.70]	.395 [10.03]	.284 [7.21]	.295 [7.49]	.150 [3.81]	.200 [5.08]
15	.650 [16.51]	.545 [13.84]	.434 [11.02]	.445 [11.30]	.300 [7.62]	.350 [8.89]
21	.800 [20.32]	.695 [17.65]	.584 [14.83]	.595 [15.11]	.450 [11.43]	.500 [12.70]
25	.900 [22.86]	.795 [20.19]	.684 [17.37]	.695 [17.65]	.550 [13.97]	.600 [15.24]
31	1.050 [26.67]	.945 [24.00]	.834 [21.18]	.845 [21.46]	.700 [17.78]	.750 [19.05]
37	1.200 [30.48]	1.095 [27.81]	.984 [24.99]	.995 [25.27]	.850 [21.59]	.900 [22.86]
51	1.550 [39.37]	1.445 [36.70]	1.334 [33.88]	1.345 [34.16]	1.200 [30.48]	1.250 [31.75]

DIMENSIONS IN [] ARE IN MILLIMETERS AND ARE FOR REFERENCE ONLY

SINGLE ROW VERTICAL THRU-HOLE (TYPE V2)

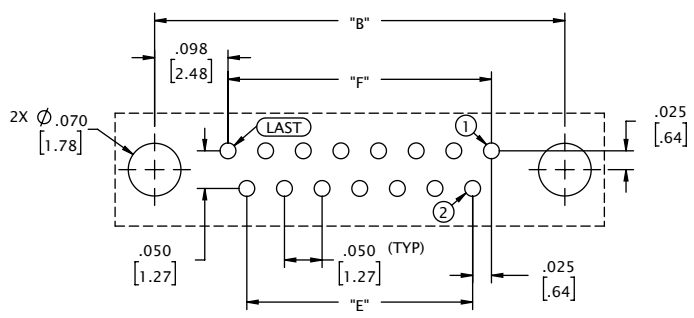
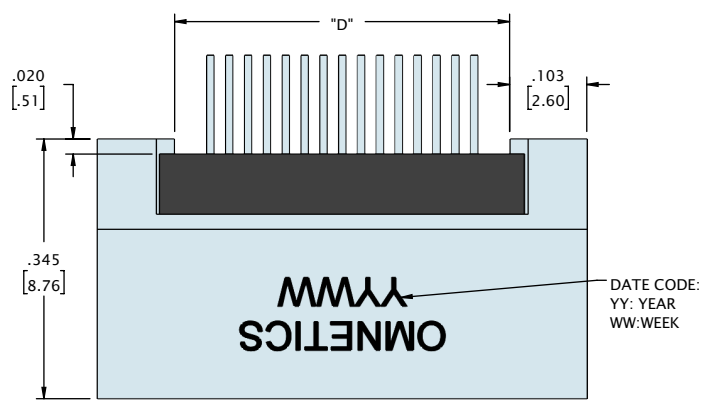

**SUGGESTED PAD LAYOUT
(VIEW FROM MOUNTING SIDE OF BOARD)**

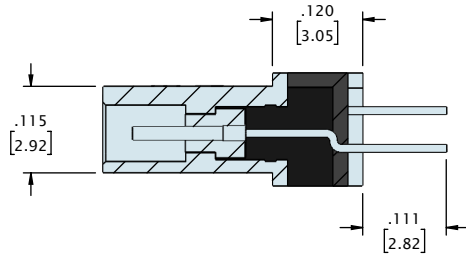
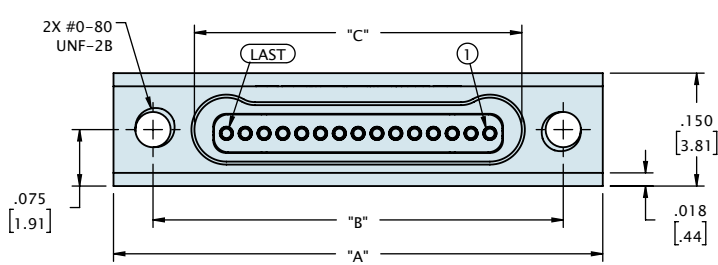

CONTACTS	"A"	"B"	"C"	"D"	"E"	"F"
05	.400 [10.16]	.295 [7.49]	.185 [4.70]	.195 [4.95]	.050 [1.27]	.100 [2.54]
09	.500 [12.70]	.395 [10.03]	.285 [7.24]	.295 [7.49]	.150 [3.81]	.200 [5.08]
15	.650 [16.51]	.545 [13.84]	.435 [11.05]	.445 [11.30]	.300 [7.62]	.350 [8.89]
21	.800 [20.32]	.695 [17.65]	.585 [14.86]	.595 [15.11]	.450 [11.43]	.500 [12.70]
25	.900 [22.86]	.795 [20.19]	.685 [17.40]	.695 [17.65]	.550 [13.97]	.600 [15.24]
31	1.050 [26.67]	.945 [24.00]	.835 [21.21]	.845 [21.46]	.700 [17.78]	.750 [19.05]
37	1.200 [30.48]	1.095 [27.81]	.985 [25.02]	.995 [25.27]	.850 [21.59]	.900 [22.86]
51	1.550 [39.37]	1.445 [36.70]	1.355 [34.42]	1.345 [34.16]	1.200 [30.48]	1.250 [31.75]

DIMENSIONS IN [] ARE IN MILLIMETERS AND ARE FOR REFERENCE ONLY

ORDERING GUIDE



1 Series	MBPS Metal Bi-Lobe Pin Single-Row	MBSS Metal Bi-Lobe Socket Single-Row
2 Number Of Contacts	05 09 15 21 25 31 37 51	
3 Termination Type	V2 Vertical Thru-Hole	
4 Shell Material & Finish	N Aluminium Shell, Electroless Nickel Plated B Aluminium Shell, Black Anodized T Titanium Shell, Unplated	CD Aluminium Shell, Cadmium Plated S Stainless Steel Shell, Passivated
5 Common Options	ETH End Threaded Hole, #0-80 NTH Non-Threaded Holes For Mounting To The Board YY Non Standard Hardware (threaded holes, thumb screws, #2-56 screw) HT High Temp. Epoxy CS Customer Supplied Material	
6 Mod Codes	M10 Custom Keying M53 Space Grade Nano-D, SPT2	M50 Space Grade Nano-D, SPT1
7 Special Instructions	YYY Describe anything that is not covered in standard options	

SINGLE ROW PRE-WIRED (TYPE WD)

Omnetics' **Pre-Wired Single Row Bi-Lobe[®]** nanos feature 30 AWG or smaller sizes of stranded wire. They are assembled using our proprietary semi-automated crimping system, as their very small size requires special care and precision to accomplish a perfect crimp. Each unit is carefully hand-inspected throughout the assembly process. Pre-crimped wires and contacts are potted in place to further protect the integrity of the crimp joint. Designers may specify wire type, size, and color coding to achieve a near-custom part. COTS versions are also available with 18" of color-coded AWG Teflon for quick turnaround. These connectors come in standard sizes ranging from 5 to 51 positions as well as custom configurations. Omnetics also offers full QPL versions of MIL-DTL-32139.



Electro-Mechanical Specifications

TYPE	PERFORMANCE
Durability	> 2000 Mating Cycles min
Temperature	-55°C to +125 °C (200 °C w/HTE)
Current rating	1 Amp per contact
Voltage Rating (DWV)	250 VAC RMS Sea Level
Insulation Resistance	5,000 Megohms @ 100 VDC
Shock	100 g's discontinuity < 10 nanoseconds
Vibration	20 g's discontinuity < 10 nanoseconds
Thermal Vacuum Outgassing	1.0% max TML, 0.1% VCM
Contact Resistance	71 milliohms (71 mV) max @ 1 Amp
Mating/Unmating Force	2.5 oz. (.71g) typical per contact

Material Specifications

TYPE	PERFORMANCE
Contact	Copper Alloy Per MIL-DTL-32139
Contact Finish	Gold per ASTM B488, Type II, Class 1.27, Code C Over Nickel Underplate
Insulator	LCP Per MIL-DTL-32139 Or PEEK
Encapsulant	Epoxy

Shell Options

TYPE	PERFORMANCE
Aluminum 6061	Electroless Nickel per SAE-AMS-2404
Stainless Steel, 300 Series	Passivated per SAE-AMS-2700

SINGLE ROW PRE-WIRED (TYPE WD)

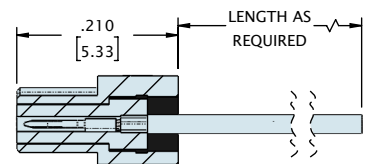
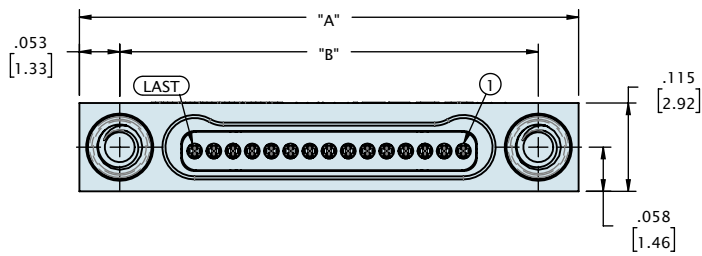
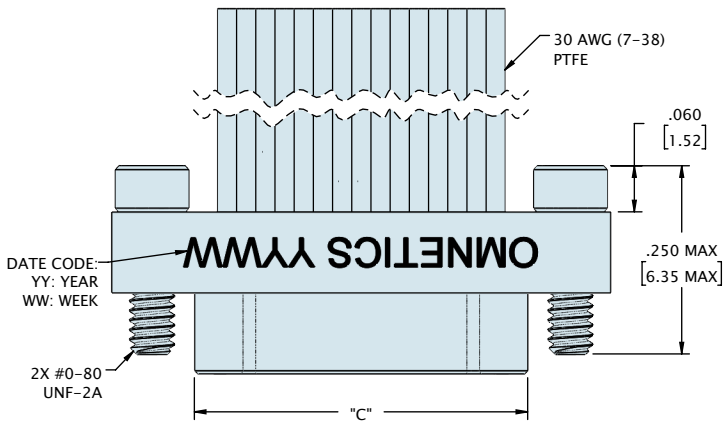
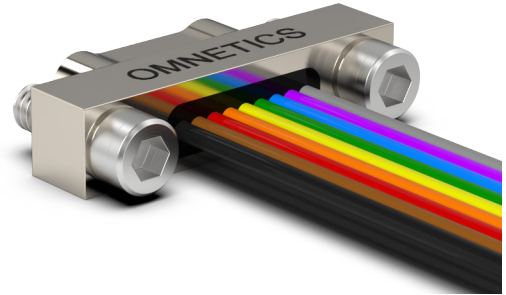
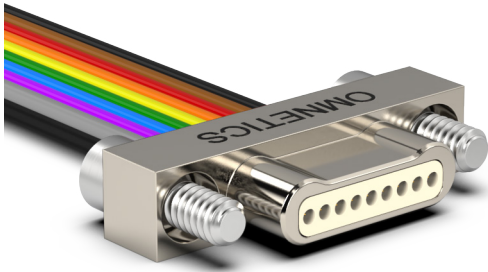

JACKSCREW NOT SHOWN FOR CLARITY

CONTACTS	"A"	"B"	"C"
05	.400 [10.16]	.295 [7.49]	.184 [4.67]
09	.500 [12.70]	.395 [10.03]	.284 [7.21]
15	.650 [16.51]	.545 [13.84]	.434 [11.02]
21	.800 [20.32]	.695 [17.65]	.584 [14.83]
25	.900 [22.86]	.795 [20.19]	.684 [17.37]
31	1.050 [26.67]	.945 [24.00]	.834 [21.18]
37	1.200 [30.48]	1.095 [27.81]	.984 [24.99]
51	1.550 [39.37]	1.445 [36.70]	1.334 [33.88]

DIMENSIONS IN [] ARE IN MILLIMETERS AND ARE FOR REFERENCE ONLY

SINGLE ROW PRE-WIRED (TYPE WD)

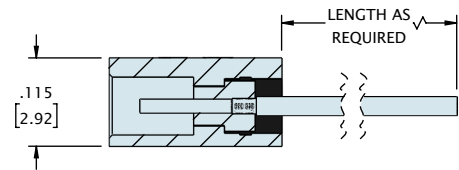
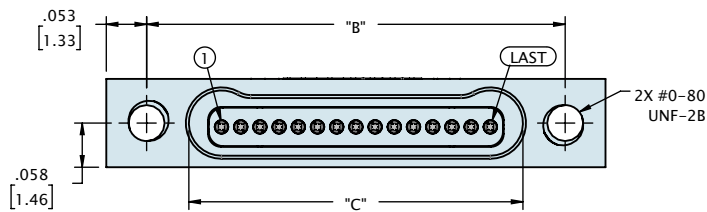
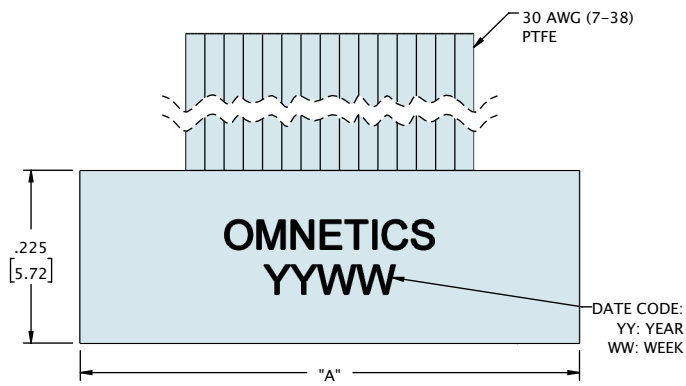

CONTACTS	"A"	"B"	"C"
05	.400 [10.16]	.295 [7.49]	.185 [4.70]
09	.500 [12.70]	.395 [10.03]	.285 [7.24]
15	.650 [16.51]	.545 [13.84]	.435 [11.05]
21	.800 [20.32]	.695 [17.65]	.585 [14.86]
25	.900 [22.86]	.795 [20.19]	.685 [17.40]
31	1.050 [26.67]	.945 [24.00]	.835 [21.21]
37	1.200 [30.48]	1.095 [27.81]	.985 [25.02]
51	1.550 [39.37]	1.445 [36.70]	1.335 [33.91]

DIMENSIONS IN [] ARE IN MILLIMETERS AND ARE FOR REFERENCE ONLY

ORDERING GUIDE

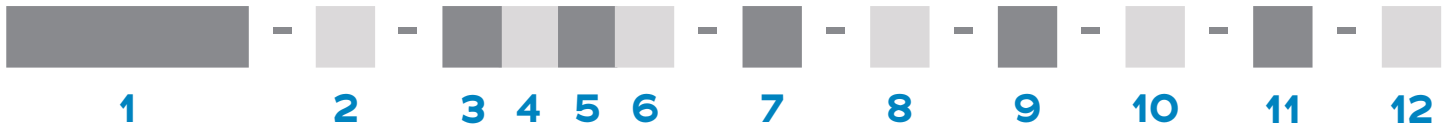

1 Series	MBPS Metal Bi-Lobe Pin Single-Row	MBSS Metal Bi-Lobe Socket Single-Row
2 Number Of Contacts	05 09 15 21 25 31 37 51	
3 Termination Type	WD Discrete Wires	
4 Wire Gage	0 30 AWG (STD)	2 32 AWG
5 Wire Type	Q NEMA HP3 (formerly M16878/4 and /6)	XX.X M22759/33 (30 AWG only)
6 Wire Length	18.0 18.00" (STD)	XX.X Custom Length
7 Color Scheme	C 10 Repeating Colors Per MIL STD 681	Y All Other Wire Colors
8 Shell Material & Finish	N Aluminum Shell, Electroless Nickel Plated B Aluminium Shell, Black Anodized T Titanium Shell, Unplated	CD Aluminium Shell, Cadmium Plated S Stainless Steel Shell, Passivated
9 Common Options	ETH End Threaded Hole, #0-80 YY Non Standard Hardware (threaded holes, thumb screws, #2-56 screw) HT High Temp. Epoxy BS1 Standard Straight Backshell BS3 90/RA Oval BSY Custom Backshell	EJS End Jack Screw RH RoHS Compliant BS2 45 Oval BS4 2 Piece BS CS Customer Supplied Material
10 Shield / Jacket	D Slip-on Braid E Machine Braid F Flexo Braid J Nomex Braid ST Shrink Tube	
11 Mod Codes	M10 Custom Keying M53 Space Grade Nano-D, SPT2	M50 Space Grade Nano-D, SPT1
12 Special Instructions	YYY Describe anything that is not covered in standard options	

SINGLE ROW JUMPERS (TYPE JUM)

Omnetics' **Single Row Bi-Lobe[®]** harnesses are built to order by Omnetics to ensure maximum flexibility in wire type, size, and color-coding. They are designed to accommodate 30 AWG and smaller stranded wire and feature .025" (.64) centerlines, which makes them an excellent choice for routing multiple lines through confined spaces. They feature Omnetics' gold-plated Flex Pin contact system. Shell material options include aluminum, titanium, and stainless steel, with custom plating options available upon request. These connectors are available in standard sizes ranging from 5 through 51 positions, as well as custom configurations.

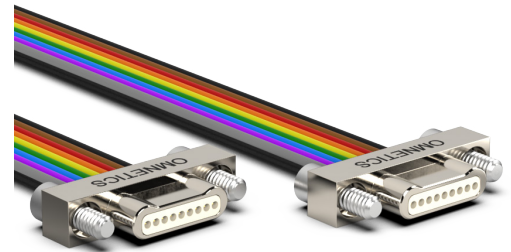

Electro-Mechanical Specifications

TYPE	PERFORMANCE
Durability	> 2000 Mating Cycles min
Temperature	-55°C to +125 °C (200 °C w/HTE)
Current rating	1 Amp per contact
Voltage Rating (DWV)	250 VAC RMS Sea Level
Insulation Resistance	5,000 Megohms @ 100 VDC
Shock	100 g's discontinuity < 10 nanoseconds
Vibration	20 g's discontinuity < 10 nanoseconds
Thermal Vacuum Outgassing	1.0% max TML, 0.1% VCM
Contact Resistance	71 milliohms (71 mV) max @ 1 Amp
Mating/Unmating Force	2.5 oz. (.71g) typical per contact

Material Specifications

TYPE	PERFORMANCE
Contact	Copper Alloy Per MIL-DTL-32139
Contact Finish	Gold per ASTM B488, Type II, Class 1.27, Code C Over Nickel Underplate
Insulator	LCP Per MIL-DTL-32139 Or PEEK
Encapsulant	Epoxy

Shell Options

TYPE	PERFORMANCE
Aluminum 6061	Electroless Nickel per SAE-AMS-2404
Stainless Steel, 300 Series	Passivated per SAE-AMS-2700

SINGLE ROW MALE TO MALE JUMPERS (TYPE JUM)

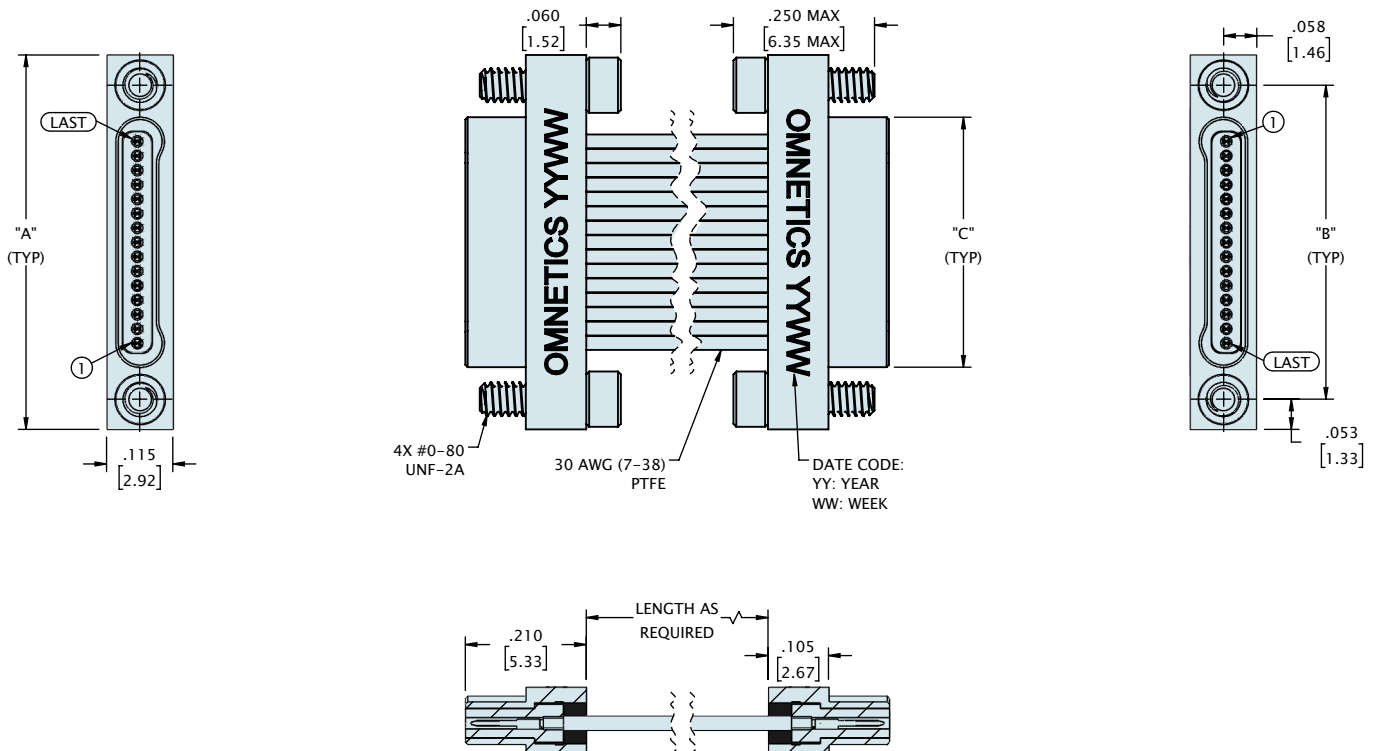
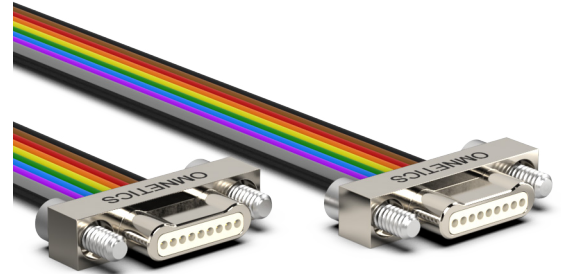
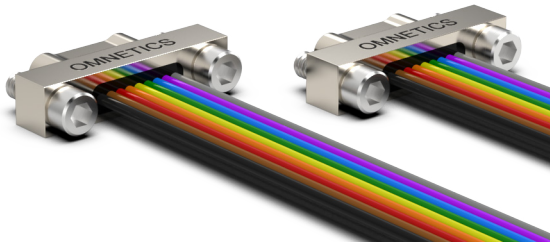

CONTACTS	"A"	"B"	"C"
05	.400 [10.16]	.295 [7.49]	.184 [4.67]
09	.500 [12.70]	.395 [10.03]	.284 [7.21]
15	.650 [16.51]	.545 [13.84]	.434 [11.02]
21	.800 [20.32]	.695 [17.65]	.584 [14.83]
25	.900 [22.86]	.795 [20.19]	.684 [17.37]
31	1.050 [26.67]	.945 [24.00]	.834 [21.18]
37	1.200 [30.48]	1.095 [27.81]	.984 [24.99]
51	1.550 [39.37]	1.445 [36.70]	1.334 [33.88]

DIMENSIONS IN [] ARE IN MILLIMETERS AND ARE FOR REFERENCE ONLY

SINGLE ROW MALE TO FEMALE JUMPERS (TYPE JUM)

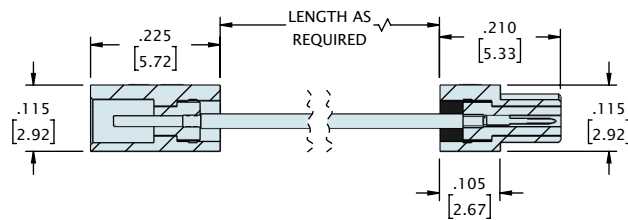
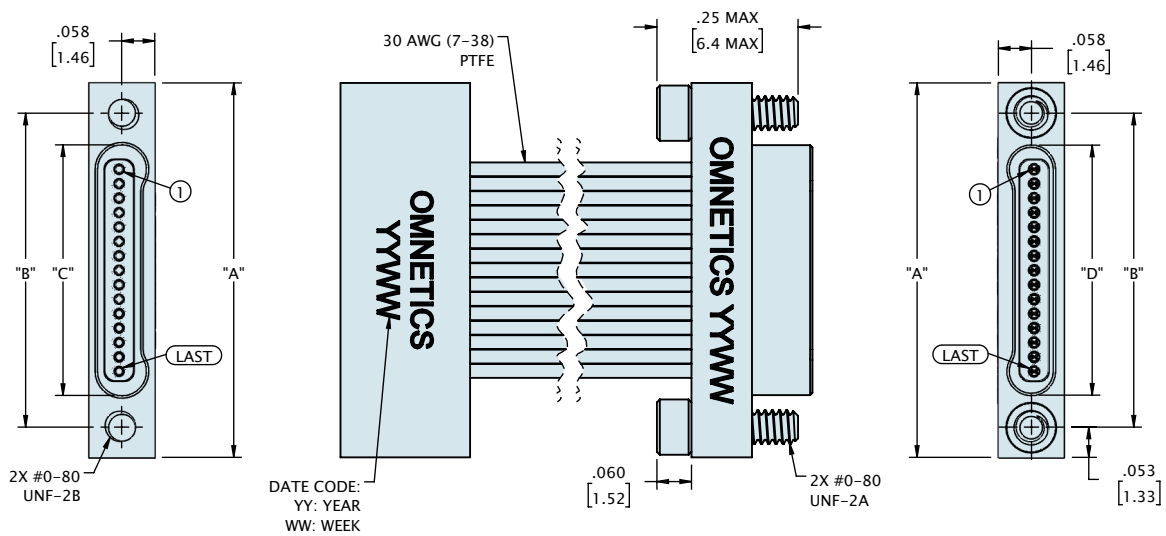
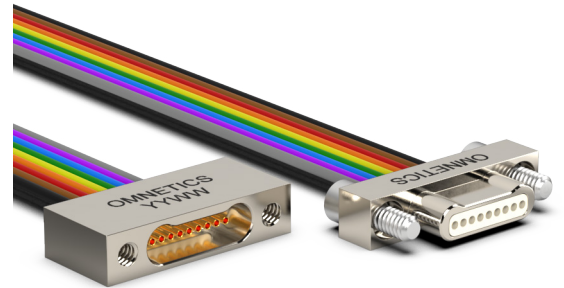
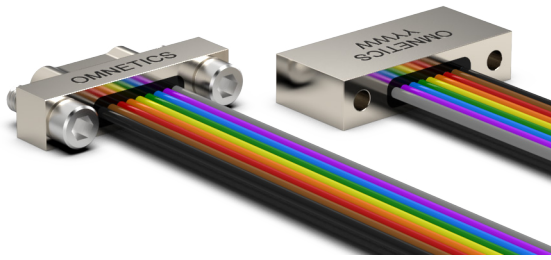

JACKSCREWS HIDDEN FOR CLARITY

CONTACTS	"A"	"B"	"C"	"D"
05	.400 [10.16]	.295 [7.49]	.185 [4.70]	.184 [4.67]
09	.500 [12.70]	.395 [10.03]	.285 [7.24]	.284 [7.21]
15	.650 [16.51]	.545 [13.84]	.435 [11.05]	.434 [11.02]
21	.800 [20.32]	.695 [17.65]	.585 [14.86]	.584 [14.83]
25	.900 [22.86]	.795 [20.19]	.685 [17.40]	.684 [17.37]
31	1.050 [26.67]	.945 [24.00]	.835 [21.21]	.834 [21.18]
37	1.200 [30.48]	1.095 [27.81]	.985 [25.02]	.984 [24.99]
51	1.550 [39.37]	1.445 [36.70]	1.335 [33.91]	1.334 [33.88]

DIMENSIONS IN [] ARE IN MILLIMETERS AND ARE FOR REFERENCE ONLY

SINGLE ROW FEMALE TO FEMALE JUMPERS (TYPE JUM)

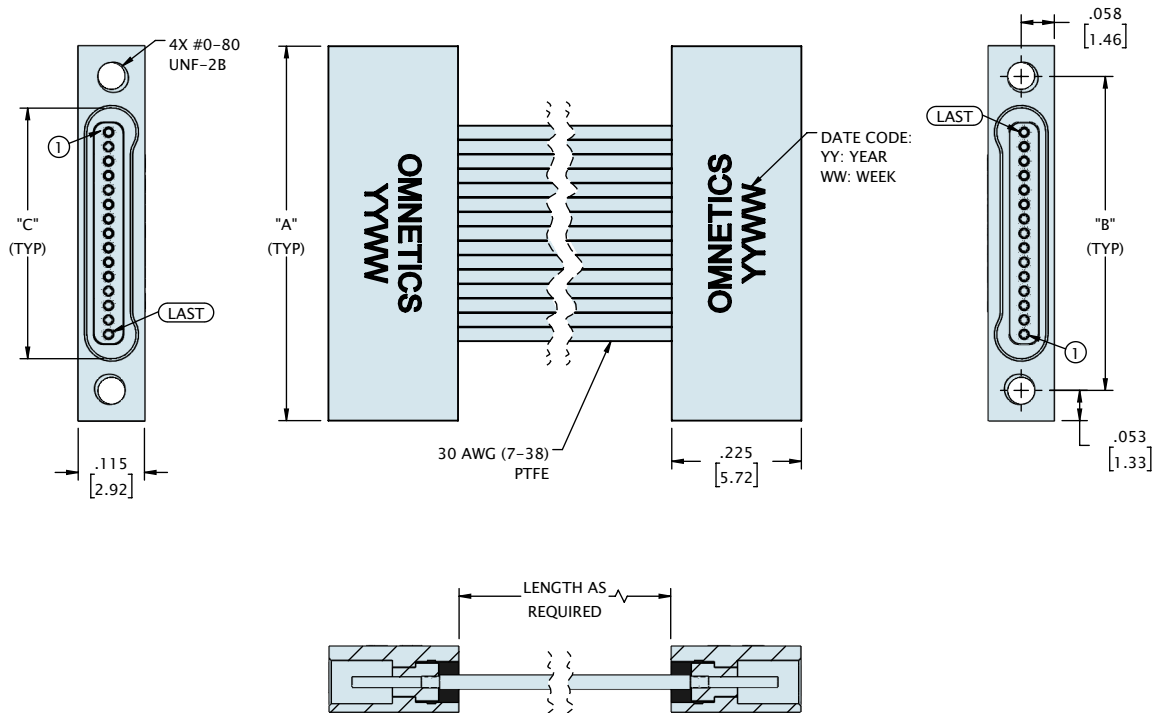
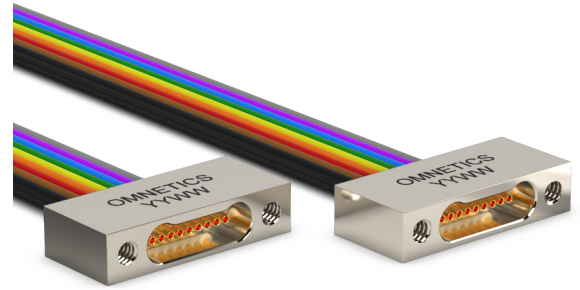
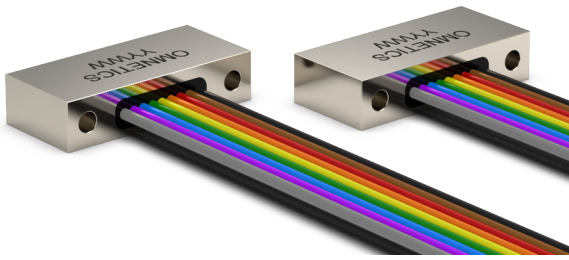

CONTACTS	"A"	"B"	"C"
05	.400 [10.16]	.295 [7.49]	.185 [4.70]
09	.500 [12.70]	.395 [10.03]	.285 [7.24]
15	.650 [16.51]	.545 [13.84]	.435 [11.05]
21	.800 [20.32]	.695 [17.65]	.585 [14.86]
25	.900 [22.86]	.795 [20.19]	.685 [17.40]
31	1.050 [26.67]	.945 [24.00]	.835 [21.21]
37	1.200 [30.48]	1.095 [27.81]	.985 [25.02]
51	1.550 [39.37]	1.445 [36.70]	1.335 [33.91]

DIMENSIONS IN [] ARE IN MILLIMETERS AND ARE FOR REFERENCE ONLY

SINGLE ROW JUMPERS (TYPE JUM)

ORDERING GUIDE

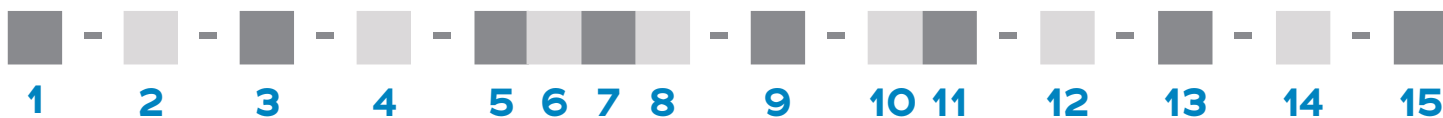

1 Series	JUM Jumpers			
2 Number Of Contacts	05	09	15	21 25 31 37 51
3 Connector 1	MBPS Metal Bi-Lobe Pin Single Row		MBSS Metal Bi-Lobe Socket Single Row	
4 Connector 2	MBPS Metal Bi-Lobe Pin Single Row		MBSS Metal Bi-Lobe Socket Single Row	
5 Termination	WD Discrete Leadwire	WC Cable	WX Multiple Wire Types	TW Twisted Wires
6 Wire AWG	0 30 AWG	2 32 AWG		
7 Wire Type	Q NEMA HP3	R M22759/11	S M22759/33	X Other Wire Types
8 Wire Length	18.0		XX.X	
9 Color Coded	C 10 Repeating Colors Per MIL STD 681			Y All Other Wire Colors
10 Shell / Material Finish	N Aluminum Shell, Electroless Nickel Plated		T Titanium Shell, Unplated	
	B Aluminium Shell, Black Anodized		CD Aluminium Shell, Cadmium Plated	
	BN Aluminium Shell, Black Nickel Plated		P Stainless Steel Shell, Passivated	
11 Hardware	See table page 103			
12 Common Options	See table page 103			
13 Shield / Jacket	D Slip On Metal Braid		E Machine Braid	F Flexo Braid
	J Nomex Braid		ST Shrink Tube	
14 Mod Codes	M50 Space Grade Micro-D, SPT1		M53 Space Grade Micro-D, SPT2	
15 Special Instructions	YYY Describe anything that is not covered in standard options			

ORDERING GUIDE



11 Hardware

- 00** None, Ø .092 Hole (STD)
- 01** Fixed Jack-Posts (STD)
- 02** Jackscrews, STD Length, Hex Head (STD)
- 03** Jackscrews, STD Length, Slotted
- 04** Jackscrews, Long, Hex
- 05** Jackscrews, Long, Slotted
- 06** Float Mount, Front Mounted
- 07** Float Mount, Rear Mounted
- 08** Non-removable
- 13** Fixed Jackspots (STD)
- 14** Jackscrews STD Length, Hex Head (STD)
- 15** One set of each, Fixed Jackspots & Jackscrews, Standard Length, Hex Head (STD)
- YY** Non Standard Hardware

12 Common Options

- | | |
|--------------------------------------|--|
| ETH End Threaded Hole, #0-80 | EJS End Jack Screw |
| HT High Temp. Epoxy | RH RoHS Compliant |
| FP Front Panel Mount | SR Strain Relief |
| CS Customer Supplied Material | RP Rear Panel Mount |
| IS Inline Shell | OR O-Ring |
| OM Overmold | BS1 Standard Straight Backshell |
| BS2 45 Oval | BS3 90/RA Oval |
| BS4 2 Piece BS | BSY Custom Backshell |

MOUNTING HARDWARE & TOOLS

Omnetics designs each of our products for maximum ease of use. Our connectors are carefully designed to offer easy handling for new installations, upgrades, and repairs using commonly available tools. We also offer U.S. standard compatible mounting hardware and tools to our customers around the world. Bi-Lobe® and MIL-DTL-32139 connectors with retention and/or mounting features, including panel mount and printed circuit board mountable versions (SMT and thru-hole), typically use a #0-80 screw. Connectors that feature retention screws come with integrated hardware. The screws are held captive within the metal connector housing and act as a positive locking mechanism to hold the mated pair of connectors together even under the most rugged operating conditions. These retention screws feature a standard hex head of .50" (1.27mm).



Please contact Omnetics or your authorized distributor to be sure you have the tools you need to work with U.S. standard hardware.

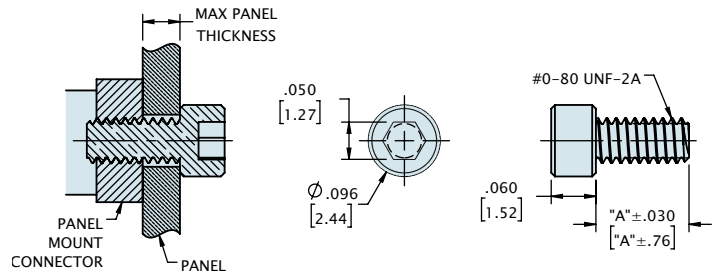
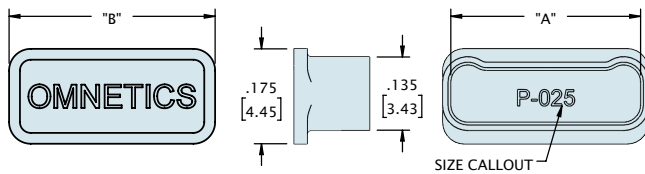
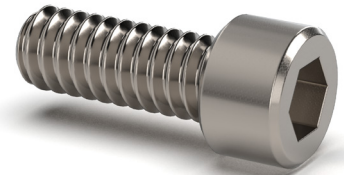
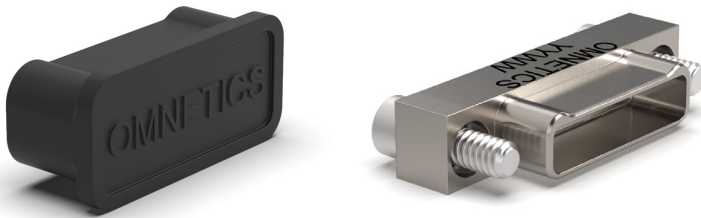

Metal dustcap available upon request

PART #	# OF CONTACTS	"A"	"B"
D6912-009	9	.150 [3.81]	.180 [4.57]
D6912-015	15	.225 [5.72]	.255 [6.48]
D6912-021	21	.300 [7.62]	.330 [8.38]
D6912-025	25	.350 [8.89]	.380 [9.65]
D6912-031	31	.425 [10.80]	.455 [11.56]
D6912-037	37	.500 [12.70]	.530 [13.46]
D6912-051	51	.675 [17.15]	.705 [17.91]
D6912-065	65	.850 [21.59]	.880 [22.35]

DIMENSIONS IN [] ARE IN MILLIMETERS AND ARE FOR REFERENCE ONLY

PART #	"A"	MAX PANEL THICKNESS
D4193-125	.125 [3.18]	.050 [1.27]
D4193-156	.156 [3.97]	.081 [2.06]
D4193-187	.188 [4.76]	.113 [2.86]
D4193-250	.250 [6.35]	.175 [4.45]
D4193-312	.313 [7.94]	.238 [6.03]
D4193-375	.375 [9.53]	.300 [7.62]

DIMENSIONS IN [] ARE IN MILLIMETERS AND ARE FOR REFERENCE ONLY

All of Omnetics' Bi-Lobe® connectors are rated for 200+ mating cycles. To support the requirements of applications that carry unique restrictions, such as limits on mating during programming, test, or burn-in, Omnetics' offers a Connector Saver product that can be mated to the corresponding connector to protect sensitive equipment and extend the life of the Bi-Lobe® connector. The Connector Saver features the Omnetics' gold-plated Flex Pin contact system and offers continuity of performance in a Bi-Lobe® connection. They are spaced on .025" (.64 mm) centerlines and can carry 1 amp per contact.

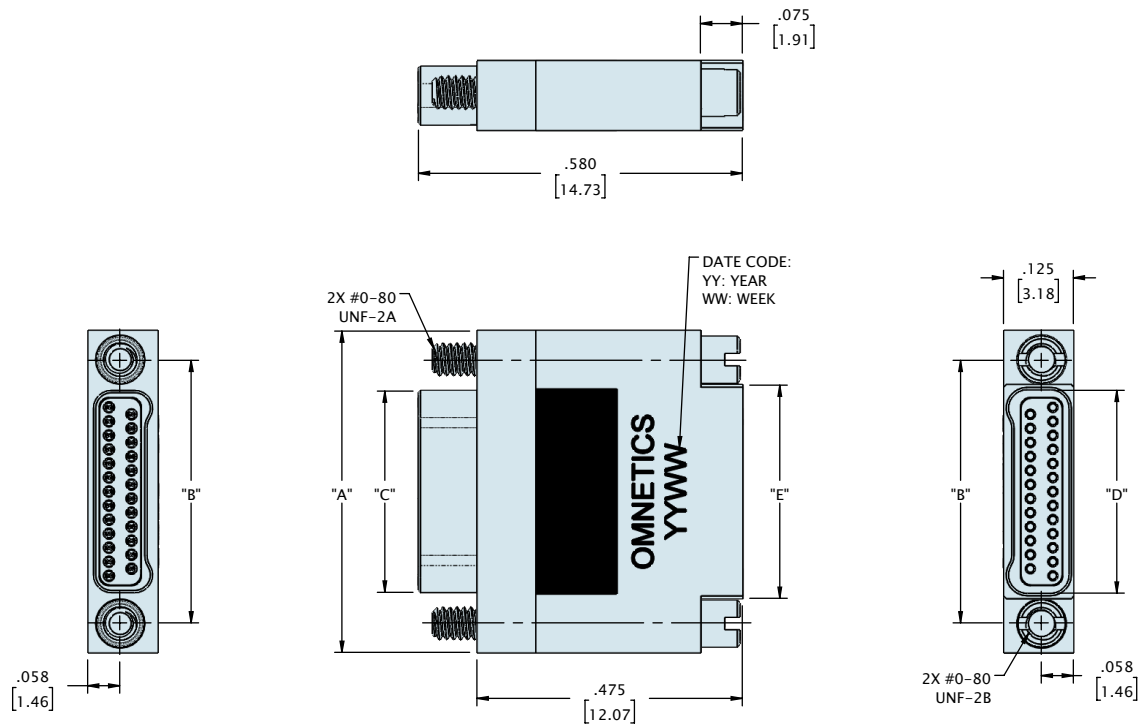
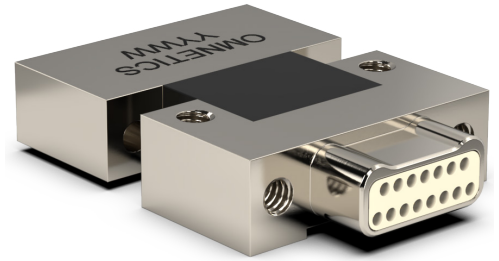

PART #	CONTACTS	"A"	"B"	"C"	"D"	"E"
A40838-009	09	.375 [9.53]	.270 [6.86]	.160 [4.06]	.163 [4.14]	.182 [4.62]
A40838-015	15	.450 [11.43]	.345 [8.76]	.235 [5.97]	.238 [6.05]	.257 [6.52]
A40838-021	21	.525 [13.34]	.420 [10.67]	.310 [7.87]	.313 [7.95]	.332 [8.43]
A40838-025	25	.575 [14.61]	.470 [11.94]	.360 [9.14]	.363 [9.22]	.382 [9.70]
A40838-031	31	.650 [16.51]	.545 [13.84]	.435 [11.05]	.438 [11.13]	.457 [11.60]
A40838-037	37	.725 [18.42]	.620 [15.75]	.510 [12.95]	.513 [13.03]	.532 [13.51]
A40838-051	51	.900 [22.86]	.795 [20.19]	.685 [17.40]	.688 [17.48]	.707 [17.95]
A40838-065	65	1.075 [27.31]	.970 [24.64]	.860 [21.84]	.863 [21.92]	.882 [22.40]
A40838-085	85	1.325 [33.66]	1.220 [30.99]	1.110 [28.19]	1.113 [28.27]	1.132 [28.75]

DIMENSIONS IN [] ARE IN MILLIMETERS AND ARE FOR REFERENCE ONLY

PANEL MOUNT CUTOUT

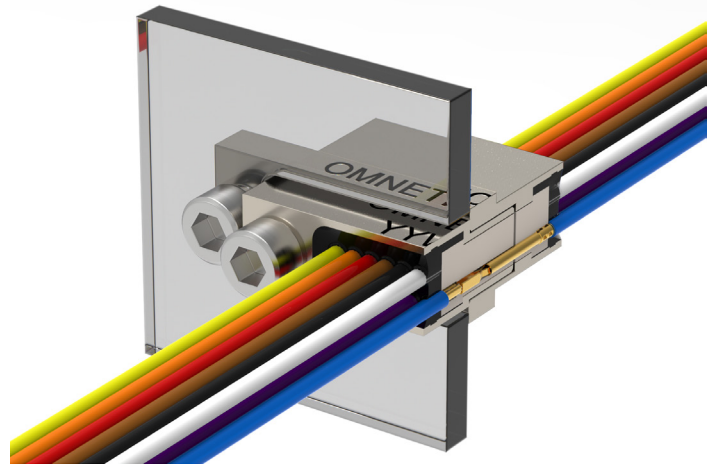
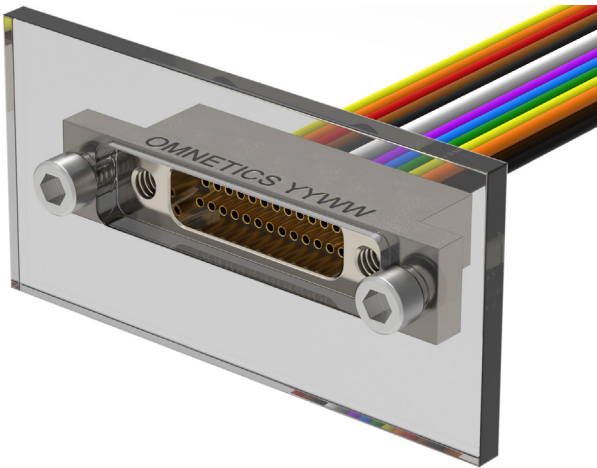

STANDARD CUTOUT

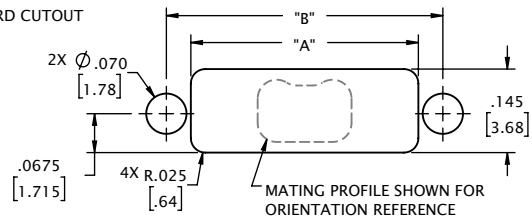

ALTERNATIVE CUTOUT

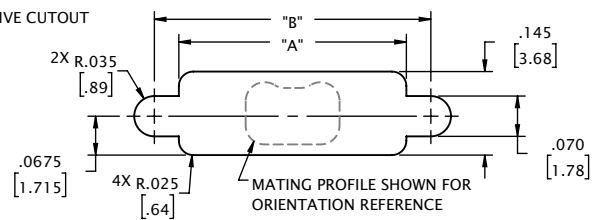

CONTACTS	"A"	"B"
09	.395 [10.03]	.480 [12.19]
15	.470 [11.94]	.555 [14.10]
21	.545 [13.84]	.630 [16.00]
25	.595 [15.11]	.680 [17.27]
31	.670 [17.02]	.755 [19.18]
37	.745 [18.92]	.830 [21.08]
51	.920 [23.37]	1.005 [25.53]
65	1.095 [27.81]	1.180 [29.97]
85	1.345 [34.16]	1.430 [36.32]

DIMENSIONS IN [] ARE IN MILLIMETERS AND ARE FOR REFERENCE ONLY