

**APEM**

## Panel Mount LED Indicators 2016



[www.apem.com](http://www.apem.com)

PANEL SWITCHES

PCB SWITCHES

JOYSTICKS

SWITCH PANELS

LED INDICATORS

# Q, QRM, QRM-NV & QS Series

## Selection Guide

### Q6 Series



- Panel mount Ø6mm
- Red, green, yellow, blue, white & orange LED
- Bi-color & super bright LED
- Prominent, recessed & flush bezels
- Bright/black chrome or satin grey finish
- 7 types of termination
- Panel sealed to IP67
- Voltage 2VDC to 28VAC/DC

Pages 3 to 7

### Q8 Series



- Panel mount Ø8mm
- Red, green, yellow, blue, white & orange LED
- Bi/Tri-color & super bright LED
- Prominent, recessed & flush bezels
- Bright/black chrome or satin grey finish
- 8 types of termination
- Panel sealed to IP67
- Voltage 2VDC to 220VAC

Pages 8 to 12

### Q12 Series



- Panel mount Ø12mm
- Red, green, yellow, blue, white & orange LED
- Bi/Tri-color & super bright LED
- Prominent bezel
- Bright/black chrome or satin grey finish
- 7 types of termination
- Panel sealed to IP67
- Voltage 2VDC to 220VAC

Pages 13 to 16

### Q14 Series



- Panel mount Ø14mm
- Red, green, yellow, blue, white & orange LED
- Bi/Tri-color & super bright LED
- Prominent, recessed & flush bezels
- Bright/black chrome or satin grey finish
- Custom engraving options
- Panel sealed to IP67
- Voltage 2VDC to 220VAC

Pages 17 to 21

### Q16 Series



- Panel mount Ø16mm
- Red, green, yellow, blue, white & orange LED
- Bi/Tri-color & super bright LED
- Prominent & flush bezels
- Bright/black chrome or satin grey finish
- Secret until lit & engraving options
- Panel sealed to IP67
- Voltage 2VDC to 220VAC

Pages 22 to 27

### Q19 Series



- Panel mount Ø19mm
- Red, green, yellow, blue, white & orange LED
- Bi/Tri-color & super bright LED
- Prominent & flush bezels
- Bright/black chrome or satin grey finish
- Custom engraving options
- Panel sealed to IP67
- Voltage 2VDC to 220VAC

Pages 28 to 32

### Q22 Series



- Panel mount Ø22mm
- Red, green, yellow, blue & white LED
- Bi/Tri-color & super bright LED
- Prominent & flush bezels
- Bright/black chrome or satin grey finish
- Custom engraving options
- Panel sealed to IP67
- Voltage 2VDC to 220VAC

Pages 33 to 37

### QRM Series



- Rear Panel Mount Ø6 & Ø8mm
- Red, green, yellow, blue & white LED
- Bi/Tri-color, hyper bright LED
- Protected bezel
- Black chrome finish
- 2 types of termination
- Panel sealed to IP67
- Voltage 2VDC to 28VAC/DC

Pages 38 to 46

### QRM-NV Series



- Rear Panel Mount Ø8mm
- NVIS Green A & B, Yellow, Red, & White
- NVIS compliant to MIL Std 3009
- Protected bezel
- Black chrome finish
- 2 types of termination
- Panel sealed to IP67
- Voltage 2VDC to 28VAC/DC

Pages 47 to 50

### QS Series



- 6 LED colors
- 2VDC to 220VAC
- Snap in LED indicators
- Push on tab or wire terminals
- Panel mount Ø6, Ø8, Ø10 & Ø12mm

For typical replacement of filament and neon indicators, offering long service life & high reliability.

Pages 51 to 54

# Q6 SERIES

Ø6mm (.236") Panel Mount LED Indicators

---



## Distinctive features

Panel mount LED indicators with 3mm colored diffused epoxy lens or 3mm water clear super bright LEDs.

Bright chrome, black chrome or satin grey bezel finish.

Prominent, recessed and flush bezel styles. Voltage: 2VDC - 28VDC.

Terminals: 2.0 x 0.5 solder lug/fastons, pins or 200mm long wires.

IP67 sealing option (EN60529).

Supplied with fixing nut and spring washer.

## Typical Applications

Process Controls

Professional Electrical Appliances

Communications, Radar

Civil engineering vehicles, trucks, diggers, crane

Trains

HVAC, Energy Management

Lifts

Machine Tools

# Q SERIES Ø6mm (.236") Panel Mount LED Indicators

## Distinctive features and specification

### Features

- 6mm panel mounting LED indicator
- 3mm colored diffused epoxy lens or 3mm water clear super bright LEDs
- Plated brass bezel finished in bright chrome, black chrome or satin grey
- Prominent, recessed and flush bezel styles
- 2VDC – 28VDC
- (2.0 x 0.5) solder lug terminals, pins or (200mm long) wire terminations
- IP67 sealing option (EN60529)
- Supplied with fixing nut and spring washer

NB: UL Recognized Component



### TECHNICAL SPECIFICATIONS

Voltage	Operating Voltage (Min to Max)	Operating Current (Typical All Types)
02 (No Resistor)	1.8 to 3.8VDC	20mA max*
6VDC	5.4 to 6.6VDC	20mA
12VDC	10.8 to 13.2VDC	20mA
24VDC	21.6 to 26.4VDC	20mA
28VDC	25.2 to 30.8VDC	20mA

Max Reverse Voltage: 5V

Viewing Angle: 30–100° (dependant on model)

Life Expectancy: 100,000 hours

Temperature Range: –40 to +85°C (operating & storage)

Torque: 4cNm

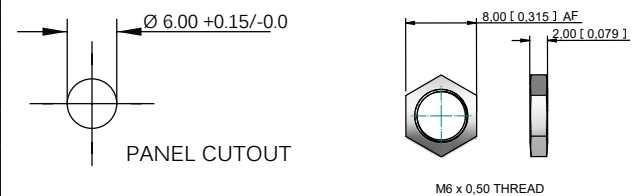

Standard LED Intensity	Prominent and Recessed	Flush	Forward Voltage
HE Red	40mcd	10mcd	2.0V
Green	40mcd	8mcd	2.2V
Yellow	30mcd	8mcd	2.1V
Blue	1,200mcd	100mcd	3.8V
White	1,200mcd	220mcd	3.8V
Orange	60mcd	10mcd	2.0V
Bi-color (Typical) (Red/Green)	20/15mcd	10/8mcd	2.0V/2.2V
The color is changed by reversing the polarity of the supply voltage.			

Super Bright LED	Prominent and Recessed	Flush	Forward Voltage
HE Red	3,500mcd	500mcd	2.2V
Green	2,000mcd	350mcd	3.5V
Yellow	900mcd	140mcd	2.3V
Blue	2800mcd	200mcd	3.3V
White	600mcd	350mcd	3.3V
Orange	10,000mcd	500mcd	2.2V

Hyper Bright LED	Prominent and Recessed	Flush	Forward Voltage
HE Red	3,700mcd	600mcd	2.2V
Green	2,000mcd	350mcd	3.2V
Yellow	1,200mcd	140mcd	2.0V
Orange	4,500mcd	400mcd	2.2V

Luminous intensity will be reduced with lower operating current.

Note: The operating voltage must not be exceeded by more than 10% as this will result in reduced life expectancy.

The company reserves the right to change specifications without notice.

\* Customer to supply resistor for desired operating current.

Luminous intensity is measured at 20mA on a discrete LED unless otherwise stated.

# Q SERIES Ø6mm (.236") Panel Mount LED Indicators

## Technical Drawings

### PROMINENT BEZEL

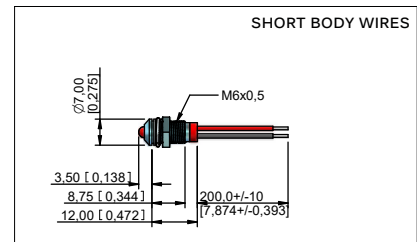
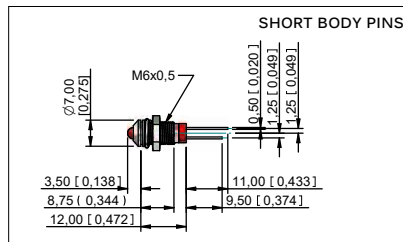
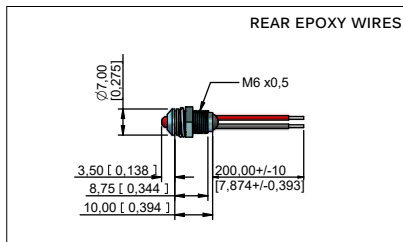
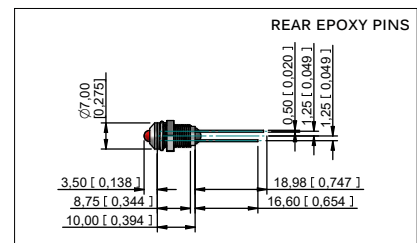
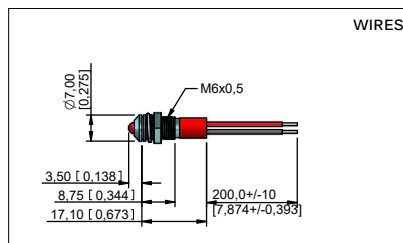
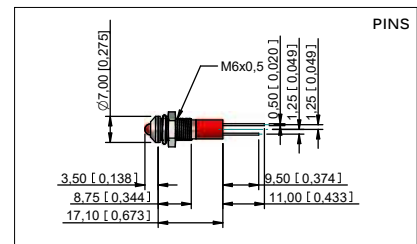
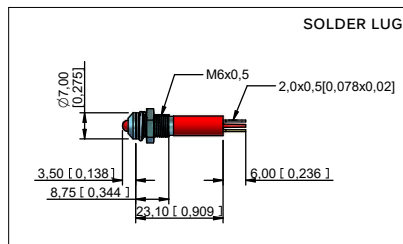

### RECESSED BEZEL

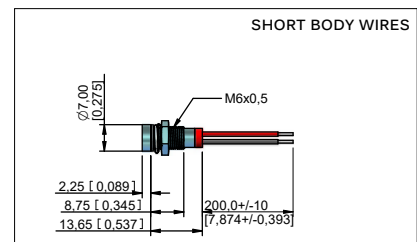
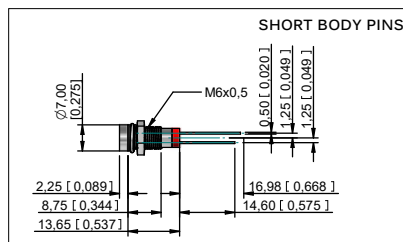
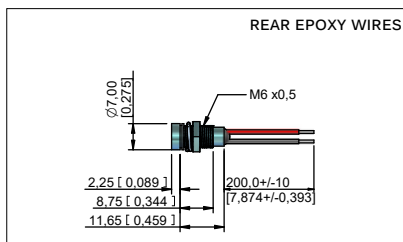
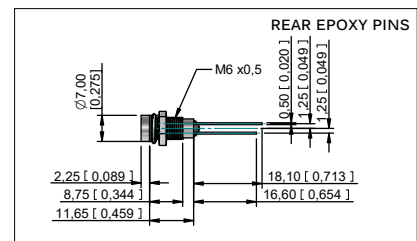
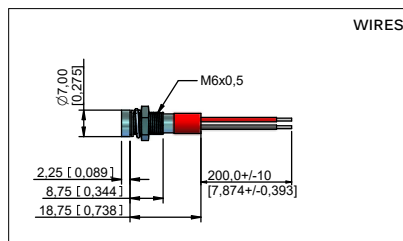
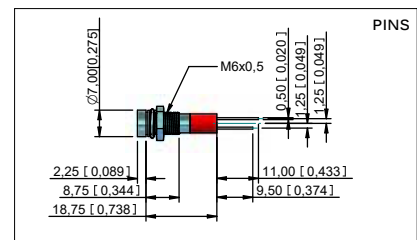
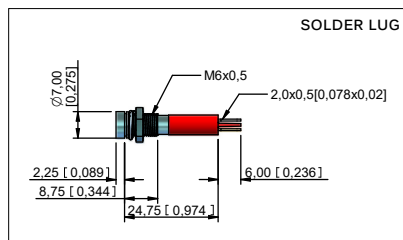



# Q SERIES Ø6mm (.236") Panel Mount LED Indicators

## Technical Drawings

FLUSH BEZEL



SOLDER LUG

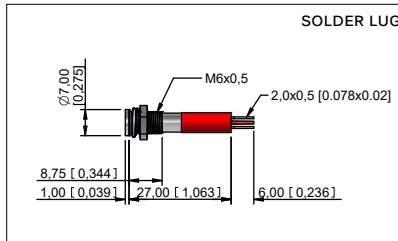

PINS

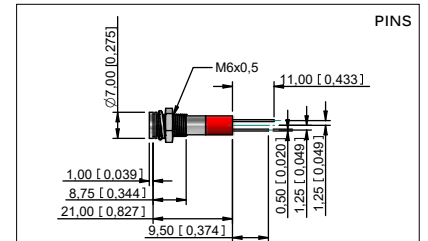

WIRES

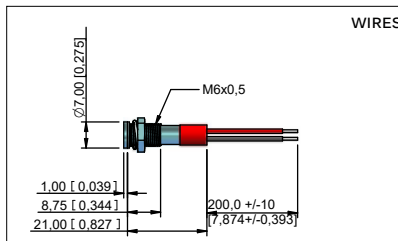

REAR EPOXY PINS

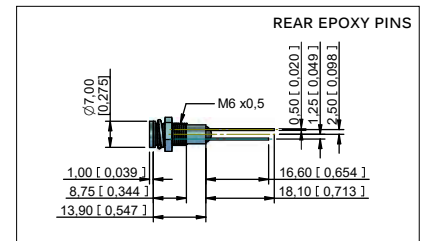

REAR EPOXY WIRES

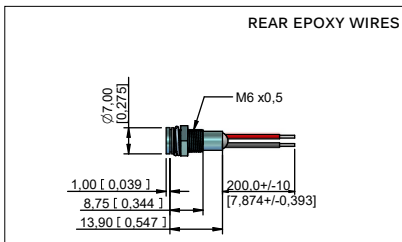

SHORT BODY PINS

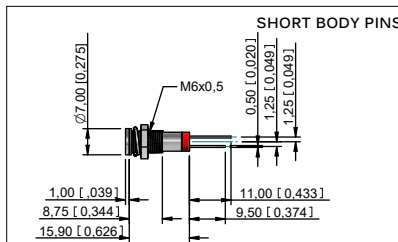

SHORT BODY WIRES

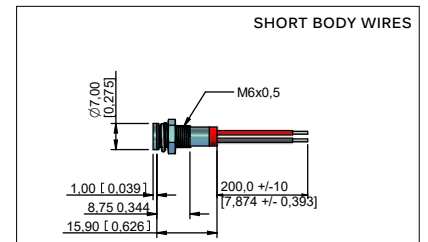

# Q SERIES Ø6mm (.236") Panel Mount LED Indicators

## Overview

### STANDARD OPTIONS

The Q6 Series is available with a range of standard options, to specify your LED, simply choose one option from each column. An example is shown below.

Q	6	P	1	B	XX	G	12	E
SERIES	MOUNTING HOLE	BEZEL STYLE	TERMINALS	BEZEL FINISH	TYPE OF ILLUMINATION	LED COLOR	VOLTAGE	SEALING
Q	6 = Ø6mm	P = Prominent R = Recessed F = Flush	1 = Solder Lug 2 = Pins 3 = Wires 4 = Rear epoxy Pins 5 = Rear epoxy Wires 6 = Short body Pins 7 = Short body Wires	C = Bright Chrome B = Black Chrome G = Satin Grey	XX = Fixed Light KK = Flashing Light (12V – 28VDC) YY = Bi-color	R = Red G = Green Y = Yellow B = Blue W = White O = Orange  HR = Hyper Bright Red HG = Hyper Bright Green HY = Hyper Bright Yellow HO = Hyper Bright Orange  SR = Super Bright Red SG = Super Bright Green SY = Super Bright Yellow SB = Super Bright Blue SW = Super Bright White SO = Super Bright Orange  RG = Red/Green RY = Red/Yellow GY = Green/Yellow	02 = no resistor* 06 = 6VDC 12 = 12VDC 12A = 12VAC/DC 24 = 24VDC 24A = 24VAC/DC 28 = 28VDC 28A = 28VAC/DC	(Blank) = Unsealed E = IP67

#### Example Q6F3CXXB12E

Ø6mm, flush bezel, wire terminals  
bright chrome finish, fixed light,  
blue, 12VDC LED, IP67 panel sealed



- Gold solder lug terminal denotes Anode (+), silver terminal denotes Cathode (-)
- Standard wire length is 200mm, 24AWG UL 1061, red wire denotes Anode (+), black wire denotes Cathode (-) for other wire lengths consult APEM
- For LEDs with alternative voltages consult APEM
- Bi-color LEDs, by connecting the gold solder lug (+) one color is produced, by reversing the supply voltage another color is produced – Bi-colors are available up to 28VDC
- Take care when soldering to the terminals (recommended solder temperature 270°C - 2 sec)
- Short body options are only available up to 24VDC
- Maximum panel thickness 7mm

\* = For resistorless versions (02) please refer to the forward voltage

# Q8 SERIES

Ø8mm (.315") Panel Mount LED Indicators

---



## Distinctive features

Panel mount LED indicators with 5mm colored diffused epoxy lens or 5mm water clear super bright LEDs.

Bright chrome, black chrome or satin grey bezel finish.

Prominent, recessed and flush bezel styles. Voltage: 2VDC - 220VAC.

Terminals: 2.8 x 0.8 solder lug/fastons, pins or 200mm long wires.

IP67 sealing option (EN60529). Supplied with fixing nut and spring washer.

## Typical Applications

Medical

Telecommunications

Engineering

Transport Systems

Special Vehicles

Agricultural Vehicles



# Q SERIES Ø8mm (.315") Panel Mount LED Indicators

## Distinctive features and specification

### Features

- 8mm panel mounting LED indicator
- 5mm colored diffused epoxy lens or 5mm water clear super bright LEDs
- Plated brass bezel finished in bright chrome, black chrome or satin grey
- Prominent, recessed and flush bezel styles
- 2VDC – 220VAC
- (2.8 x 0.8) solder lug/faston terminals, pins or (200mm long) wire terminations  
(2.0 x 0.5) solder lug/faston terminals on tricolor versions
- IP67 sealing option (EN60529)
- Supplied with fixing nut and spring washer



NB: UL Recognized Component

### TECHNICAL SPECIFICATIONS

Voltage	Operating Voltage	Operating Current
	(Min to Max)	(Typical All Types)
02 (No Resistor)	1.8 to 3.3VDC	20mA max*
6VDC	5.4 to 6.6VDC	20mA
12VDC	10.8 to 13.2VDC	20mA
24VDC	21.6 to 26.4VDC	20mA
28VDC	25.2 to 30.8VDC	20mA
110VAC	99 to 121VAC	6mA
220VAC	207 to 253VAC	3mA

Max Reverse Voltage: 5V

Viewing Angle: 30–100° (dependant on model)

Life Expectancy: 100,000 hours

Temperature Range: –40 to +85°C (operating & storage)

Torque: 20 to 25cNm

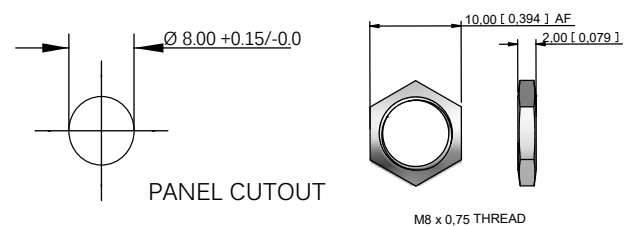

PANEL CUTOUT

M8 x 0.75 THREAD

Standard LED Intensity	Prominent and Recessed	Flush	Forward Voltage
HE Red	100mcd	12mcd	2.0V
Green	60mcd	8mcd	2.2V
Yellow	50mcd	6mcd	2.1V
Blue	1600mcd	200mcd	3.3V
White	1600mcd	500mcd	3.3V
Orange	45mcd	110mcd	2.2V
Bi-color (Typical) (Red/Green)	30/12mcd	15/10mcd	2.0V/2.2V
Tri-color (Typical) (Red/Green/Yellow)	60/15/13mcd	15/10/6mcd	2.0V/2.2V/2.1V

Bi-color - The color is changed by reversing the polarity of the supply voltage.

Tri-color - The indicator has red and green LEDs, when both connected yellow is produced.

Super Bright LED	Prominent and Recessed	Flush	Forward Voltage
HE Red	10,000mcd	1300mcd	2.2V
Green	10,000mcd	120mcd	3.3V
Yellow	3,300mcd	350mcd	2.0V
Blue	2,200mcd	280mcd	3.3V
White	2,500mcd	350mcd	3.3V
Orange	4,000mcd	500mcd	2.2V

Hyper Bright LED	Prominent and Recessed	Flush	Forward Voltage
HE Red	6,000mcd	980mcd	2.2V
Green	1,900mcd	300mcd	3.3V
Yellow	2,100mcd	250mcd	2.0V
Orange	4,500mcd	110mcd	2.2V

Luminous intensity will be reduced with lower operating current.

Note: The operating voltage must not be exceeded by more than 10% as this will result in reduced life expectancy.

The company reserves the right to change specifications without notice.

\* Customer to supply resistor for desired operating current.

Luminous intensity is measured at 20mA on a discrete LED unless otherwise stated.

Luminous intensities and color shades of white LEDs may vary within a batch.

# Q SERIES Ø8mm (.315") Panel Mount LED Indicators

## Technical Drawings

### PROMINENT BEZEL

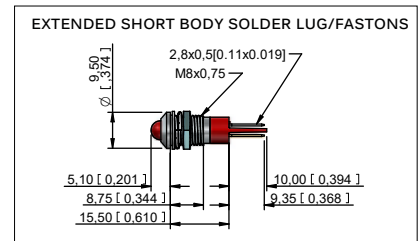
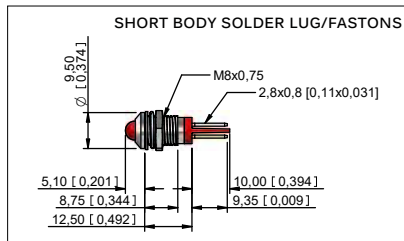
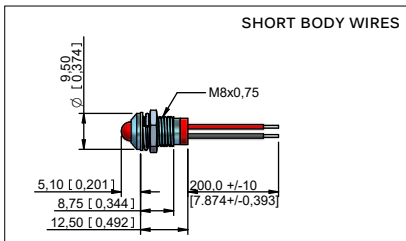
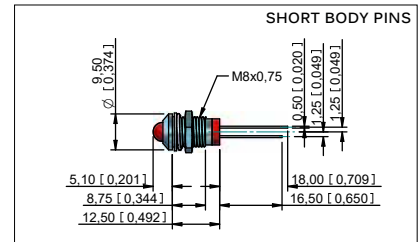
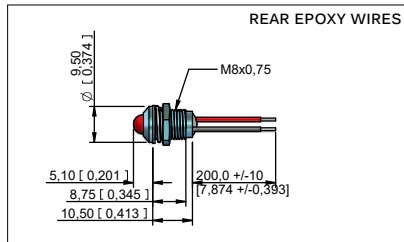
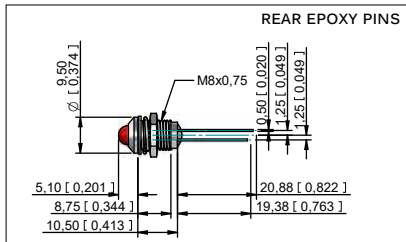
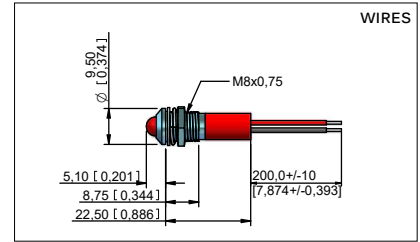
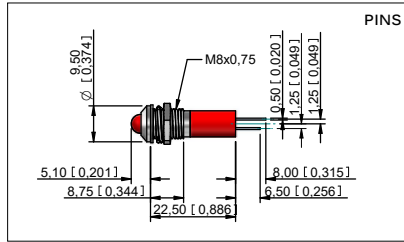
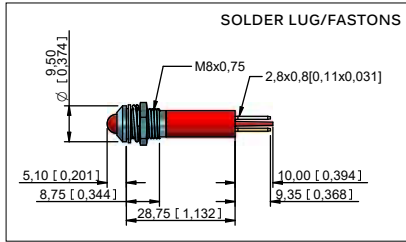

### RECESSED BEZEL

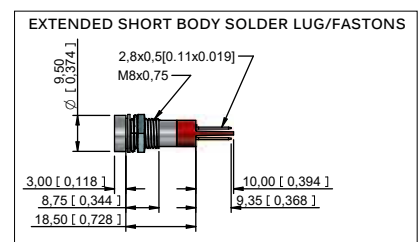
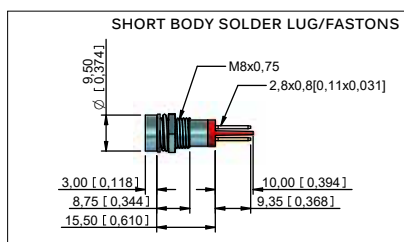
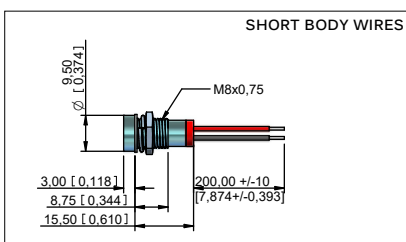
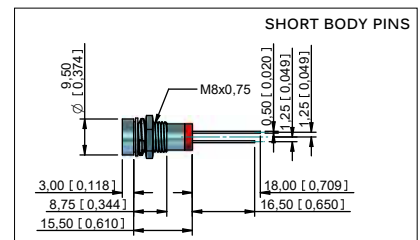
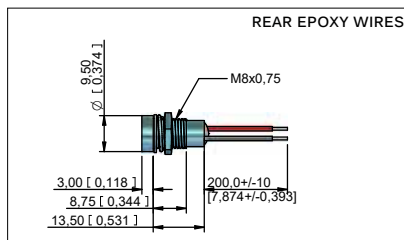
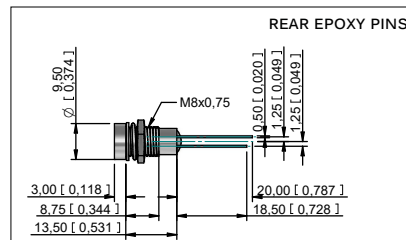
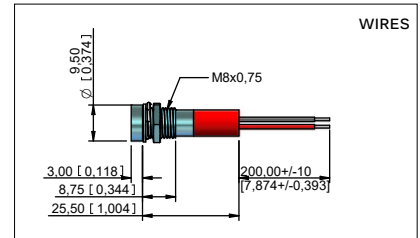
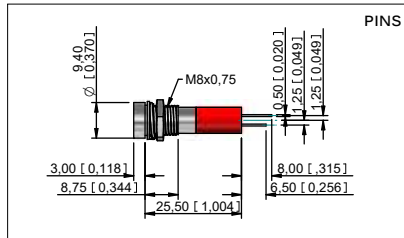
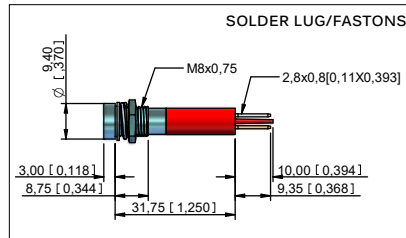

# Q SERIES Ø8mm (.315") Panel Mount LED Indicators

## Technical Drawings

### FLUSH BEZEL

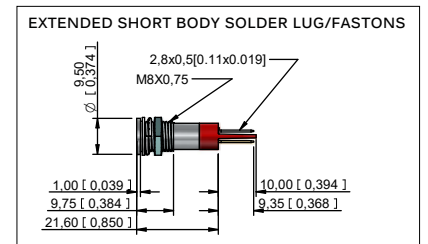
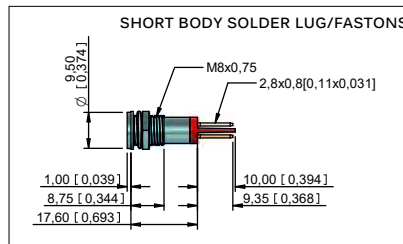
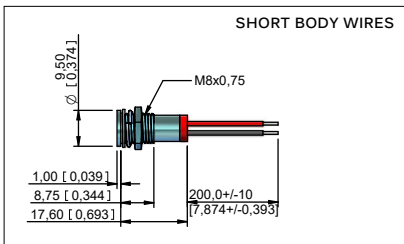
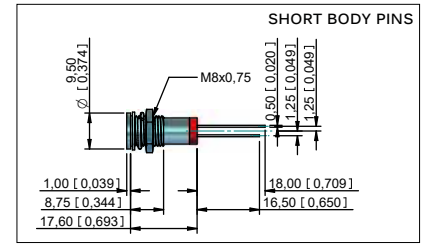
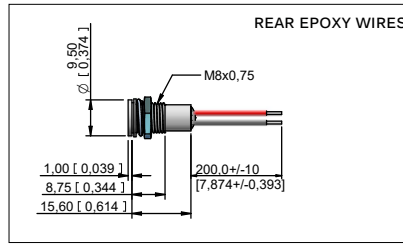
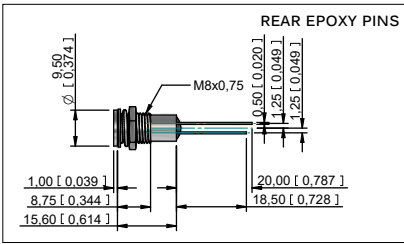
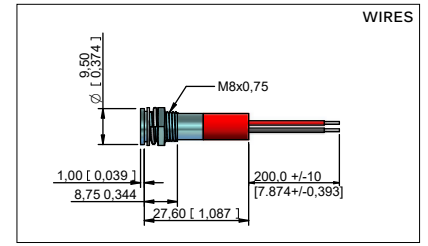
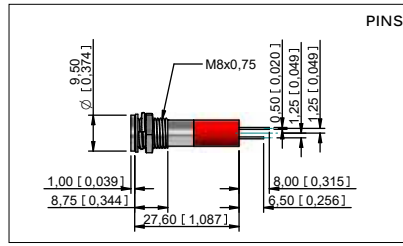
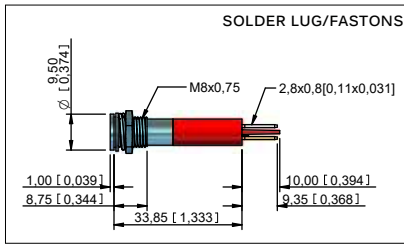

# Q SERIES Ø8mm (.315") Panel Mount LED Indicators

## Overview

### STANDARD OPTIONS

The Q8 Series is available with a range of standard options, to specify your LED, simply choose one option from each column. An example is shown below.

Q	8	P	8	G	XX	Y	12	E
SERIES	MOUNTING HOLE	BEZEL STYLE	TERMINALS	BEZEL FINISH	TYPE OF ILLUMINATION	LED COLOR	VOLTAGE	SEALING
Q	8 = Ø8mm	P = Prominent R = Recessed F = Flush	1 = Solder Lug/ Fastons (2.8 x 0.8) 2 = Pins 3 = Wires 4 = Rear epoxy Pins 5 = Rear epoxy Wires 6 = Short body Pins 7 = Short body Wires 8 = Short body Lug/ Fastons (2.8 x 0.8) 9 = Extended short body solder Lug/ Fastons (2.8 x 0.5)	C = Bright Chrome B = Black Chrome G = Satin Grey	XX = Fixed Light KK = Flashing Light (12V – 28VDC) YY = Bi-color ZZ = Tri-color	R = Red G = Green Y = Yellow B = Blue W = White O = Orange  HR = Hyper Bright Red HG = Hyper Bright Green HY = Hyper Bright Yellow HO = Hyper Bright Orange  SR = Super Bright Red SG = Super Bright Green SY = Super Bright Yellow SB = Super Bright Blue SW = Super Bright White SO = Super Bright Orange  RG = Red/Green RY = Red/Yellow GY = Green/Yellow  RYG = Red/Yellow/Green	02 = no resistor* 06 = 6VDC 12 = 12VDC 12A = 12VAC/DC 24 = 24VDC 24A = 24VAC/DC 28 = 28VDC 28A = 28VAC/DC 110 = 110VAC 220 = 220VAC	(Blank) = Unsealed E = IP67

#### Example Q8P3CXXY02E

Ø8mm, prominent bezel, 200mm wire termination  
bright chrome finish, fixed light, yellow  
2VDC LED, IP67 panel sealed



- Gold Faston terminal denotes Anode (+), silver terminal denotes Cathode (-)
- Standard wire length is 200mm, 24AWG UL1061, red wire denotes Anode (+), black wire denotes Cathode (-) for other wire lengths consult APEM
- For LEDs with alternative voltages consult APEM
- Bi-color LEDs, by connecting the gold Faston (+) one color is produced, by reversing the supply voltage another color is produced – Bi-colors are available up to 28VDC. [AC products not available]
- Take care when soldering to the Faston terminals (recommended solder temperature 270°C - 2 sec)
- Terminal options 6,7 & 9 are only available up to 28V (DC Only) tri-color not available with terminal 9
- Terminal code 8 is only available without integral resistor
- Maximum panel thickness 7mm
- We recommend using Hyperbright or Superbright LEDs for use at 110VAC and 220VAC
- The Tri-color LED has red and green LEDs when both are connected yellow is produced
- Standard Tri-color Faston terminals are two Anodes (+) and one Cathode (-)
- Tri-color wires are one red (+) and one green (+) Anode and one black (-) Cathode
- Tri-color pins are center (-) Cathode, shortest (+) Anode pin green, longest (+) Anode pin red

\* = For resistorless versions (02) please refer to the forward voltage

# Q12 SERIES

Ø12mm (.472") Panel Mount LED Indicators

---



## Distinctive features

Panel mount LED indicators with 8mm colored diffused epoxy lens or 8mm water clear super bright LEDs.

Bright chrome, black chrome or satin grey bezel finish.

Prominent bezel style. Voltage: 2VDC - 220VAC.

Terminals: 2.8 x 0.8 solder lug/faston, pins or 200mm long wires.

IP67 sealing option (EN60529). Supplied with fixing nut and spring washer.

## Typical Applications

Process Controls

Professional Electrical Appliances

Communications, Radar

Civil engineering vehicles, trucks, diggers, crane

Trains

HVAC, Energy Management

Lifts

Machine Tools

# Q SERIES Ø12mm (.472") Panel Mount LED Indicators

## Distinctive features and specification

### Features

- 12mm panel mounting LED indicator
- 8mm colored diffused epoxy lens or 8mm water clear super bright LEDs
- Plated brass bezel finished in bright chrome, black chrome or satin grey
- Prominent bezel style
- 2VDC – 220VAC
- (2.8 x 0.8) solder lug/faston terminals, pins or (200mm long) wire terminations
- IP67 sealing option (EN60529)
- Supplied with fixing nut and spring washer



NB: UL Recognized Component

### TECHNICAL SPECIFICATIONS

Voltage	Operating Voltage (Min to Max)	Operating Current (Typical All Types)
02 (No Resistor)	1.8 to 3.3VDC	20mA max*
6VDC	5.4 to 6.6VDC	20mA
12VDC	10.8 to 13.2VDC	20mA
24VDC	21.6 to 26.4VDC	20mA
28VDC	25.2 to 30.8VDC	20mA
110VAC	99 to 121VAC	6mA
220VAC	207 to 253VAC	3mA

Max Reverse Voltage: 5V

Viewing Angle: 30–100° (dependant on model)

Life Expectancy: 100,000 hours

Temperature Range: –40 to +85°C (operating & storage)

Torque: 75cNm

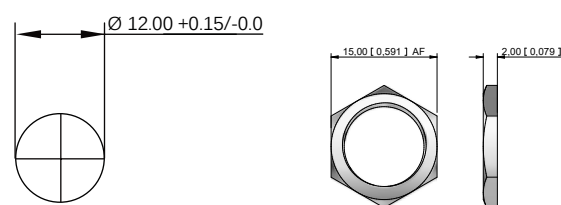

PANEL CUTOUT

M12 x 0.75 THREAD

Standard LED Intensity	Prominent	Forward Voltage
HE Red	350mcd	2.0V
Green	60mcd	2.2V
Yellow	50mcd	2.1V
Blue	800mcd	3.3V
White	1100mcd	3.3V
Orange	100mcd	2.0V
Bi-color (Typical) (Red/Green)	20/10mcd	2.0V/2.2V
Tri-color (Typical) (Red/Green/Yellow)	80/15/13mcd	2.0V/2.2V/2.1V

Bi-color - The color is changed by reversing the polarity of the supply voltage.

Tri-color - The indicator has red and green LEDs, when both connected yellow is produced.

Super Bright LED	Prominent	Forward Voltage
HE Red	3,000mcd	2.2V
Green	8,000mcd	3.3V
Yellow	1,400mcd	2.3V
Blue	1,500mcd	3.3V
White	1,200mcd	3.3V
Orange	2,000mcd	2.2V

Hyper Bright LED	Prominent	Forward Voltage
HE Red	1,200mcd	2.0V
Green	2,200mcd	3.3V
Yellow	1,600mcd	2.0V
Orange	4,300mcd	2.2V

Luminous intensity will be reduced with lower operating current.

Note: The operating voltage must not be exceeded by more than 10% as this will result in reduced life expectancy.

The company reserves the right to change specifications without notice.

\* Customer to supply resistor for desired operating current.

Luminous intensity is measured at 20mA on a discrete LED unless otherwise stated.

Luminous intensities and color shades of white LEDs may vary within a batch.



# Q SERIES Ø12mm (.472") Panel Mount LED Indicators

## Technical Drawings

### PROMINENT BEZEL

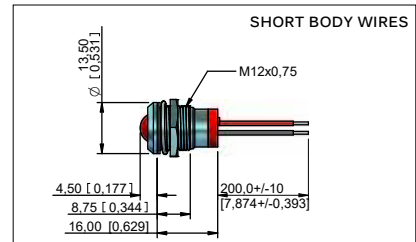
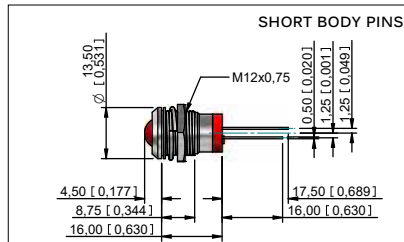
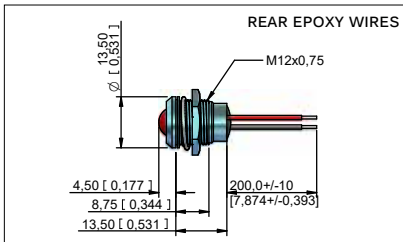
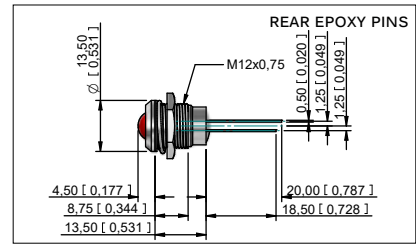
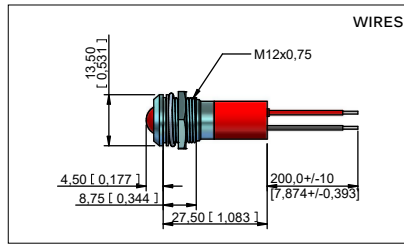
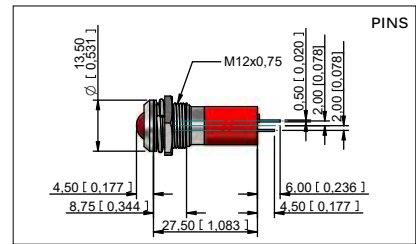
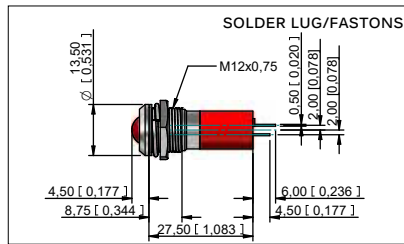

# Q SERIES Ø12mm (.472") Panel Mount LED Indicators

## Overview

### STANDARD OPTIONS

The Q12 Series is available with a range of standard options, to specify your LED, simply choose one option from each column. An example is shown below.

Q	12	P	1	B	XX	G	12	E
SERIES	MOUNTING HOLE	BEZEL STYLE	TERMINALS	BEZEL FINISH	TYPE OF ILLUMINATION	LED COLOR	VOLTAGE	SEALING
Q	12 = Ø12mm	P = Prominent	1 = Solder Lug/Fastons (2.8 x 0.8) 2 = Pins 3 = Wires 4 = Rear epoxy Pins 5 = Rear epoxy Wires 6 = Short body Pins 7 = Short body Wires	C = Bright Chrome B = Black Chrome G = Satin Grey	XX = Fixed Light KK = Flashing Light (12 - 28VDC) YY = Bi-color ZZ = Tri-color	R = Red G = Green Y = Yellow B = Blue W = White O = Orange  HR = Hyper Bright Red HG = Hyper Bright Green HY = Hyper Bright Yellow HO = Hyper Bright Orange  SR = Super Bright Red SG = Super Bright Green SY = Super Bright Yellow SB = Super Bright Blue SW = Super Bright White SO = Super Bright Orange  RG = Red/Green RY = Red/Yellow GY = Green/Yellow  RYG = Red/Yellow/Green	02 = no resistor* 06 = 6VDC 12 = 12VDC 12A = 12VAC/DC 24 = 24VDC 24A = 24VAC/DC 28 = 28VDC 28A = 28VAC/DC 110 = 110VAC 220 = 220VAC	(Blank) = Unsealed E = IP67

#### Example Q12P7GXXG12E

Ø12mm, prominent bezel, short body wires, satin chrome finish, fixed light, green, 12VDC LED, IP67 panel sealed



- Gold Faston terminal denotes Anode (+), silver terminal denotes Cathode (-)
- Standard wire length is 200mm, 24AWG UL1061, red wire denotes Anode (+), black wire denotes Cathode (-) for other wire lengths consult APEM
- For LEDs with alternative voltage consult APEM
- Bi-color LEDs, by connecting the gold Faston (+) one color is produced, by reversing the supply voltage another color is produced – Bi-colors are available up to 28VDC
- Take care when soldering to the Faston terminals (recommended solder temperature 270°C - 2 sec)
- Max voltage for pins and wires is 28V
- Maximum panel thickness 7mm
- Tri-colors are only available behind panel epoxy sealed with wires (option 1) or pins (option 3)
- 110VAC and 220VAC only available with solder lug/faston terminals
- We recommend using Hyperbright or Superbright LEDs for use at 110VAC and 220VAC
- The Tri-color LED has red and green LEDs when both are connected yellow is produced
- Standard Tri-color Faston terminals are two Anodes (+) and one Cathode (-)
- Tri-color wires are one red (+) and one green (+) Anode and one black (-) Cathode
- Tri-color pins are center (-) Cathode, shortest (+) Anode pin green, longest (+) Anode pin red

\* = For resistorless versions (02) please refer to the forward voltage

# Q14 SERIES

Ø14mm (.551") Panel Mount LED Indicators

---



## Distinctive features

Panel mount LED indicators with 10mm colored diffused epoxy lens or 10mm water clear super bright LEDs.

Custom engraving available

Bright chrome, black chrome or satin grey bezel finish.

Prominent and flush bezel styles. voltage: 2VDC - 220VAC.

Terminals: 2.8 x 0.8 solder lug/fastons, pins or 200mm long wires.

IP67 sealing option (EN60529). Supplied with fixing nut and spring washer.

## Typical Applications

Process Controls

Professional Electrical Appliances

Communications, Radar

Civil engineering vehicles, trucks, diggers, crane

Trains

HVAC, Energy Management

Lifts

Machine Tools

# Q SERIES Ø14mm (.551") Panel Mount LED Indicators

## Distinctive features and specification

VOYC1511US

### Features

- 14mm panel mounting LED indicator
- 10mm colored diffused epoxy lens or 10mm water clear super bright LEDs
- Plated brass bezel finished in bright chrome, black chrome or satin grey
- Prominent and flush bezel styles
- Custom engraving available
- 2VDC – 220VAC
- (2.8 x 0.8) solder lug/Faston terminals, pins or (200mm long) wire terminations
- IP67 sealing option (EN60529)
- Supplied with fixing nut and spring washer



NB: UL Recognized Component

### TECHNICAL SPECIFICATIONS

Voltage	Operating Voltage	Operating Current
	(Min to Max)	(Typical All Types)
02 (No Resistor)	1.8 to 3.3VDC	20mA max*
6VDC	5.4 to 6.6VDC	20mA
12VDC	10.8 to 13.2VDC	20mA
24VDC	21.6 to 26.4VDC	20mA
28VDC	25.2 to 30.8VDC	20mA
110VAC	99 to 121VAC	6mA
220VAC	207 to 253VAC	3mA

**Max Reverse Voltage:** 5V

**Viewing Angle:** 30–100° (dependant on model)

**Life Expectancy:** 100,000 hours

**Temperature Range:** –40 to +85°C (operating & storage)

**Torque:** 75cNm

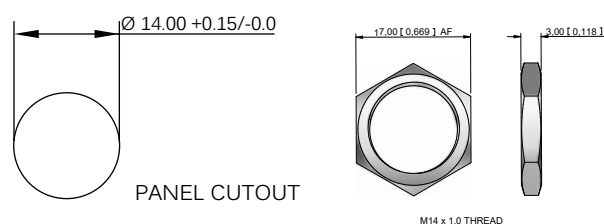

Standard LED Intensity	Prominent	Flush	Forward Voltage
HE Red	100mcd	10mcd	2.0V
Green	60mcd	5mcd	2.2V
Yellow	50mcd	4mcd	2.1V
Blue	540mcd	100mcd	3.3V
White	1000mcd	120mcd	3.3V
Orange	100mcd	200mcd	2.0V
Bi-color (Typical) (Red/Green)	15/15mcd	14/10mcd	2.0V/2.2V
Tri-color (Typical) (Red/Green/Yellow)	80/50/50mcd	180/30/30mcd	2.0V/2.2V/2.1V

Bi-color - The color is changed by reversing the polarity of the supply voltage.

Tri-color - The indicator has red and green LEDs, when both connected yellow is produced.

Super Bright LED	Prominent	Flush	Forward Voltage
HE Red	17,000mcd	2000mcd	2.2V
Green	4,100mcd	680mcd	3.5V
Yellow	2,500mcd	350mcd	2.3V
Blue	2,500mcd	300mcd	3.3V
White	4,400mcd	200mcd	3.3V
Orange	2800mcd	300mcd	2.1V

Hyper Bright LED	Prominent	Flush	Forward Voltage
HE Red	2,800mcd	800mcd	2.1V
Green	2,200mcd	250mcd	3.2V
Yellow	1,300mcd	250mcd	2.0V
Orange	850mcd	200mcd	2.1V

Luminous intensity will be reduced with lower operating current.

Note: The operating voltage must not be exceeded by more than 10% as this will result in reduced life expectancy.

The company reserves the right to change specifications without notice.

\* Customer to supply resistor for desired operating current.

Luminous intensity is measured at 20mA on a discrete LED unless otherwise stated.

Luminous intensities and color shades of white LEDs may vary within a batch.

# Q SERIES Ø14mm (.551") Panel Mount LED Indicators

## Technical Drawings

### PROMINENT BEZEL

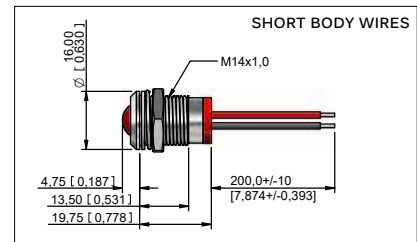
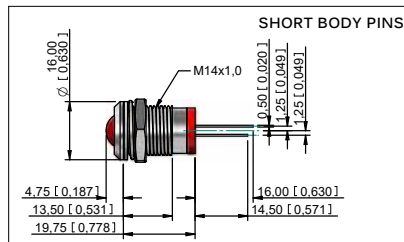
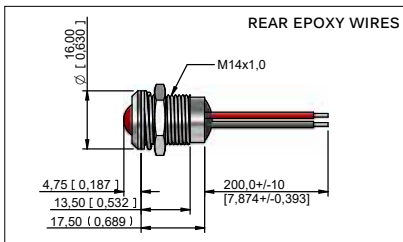
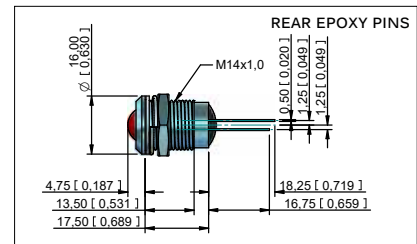
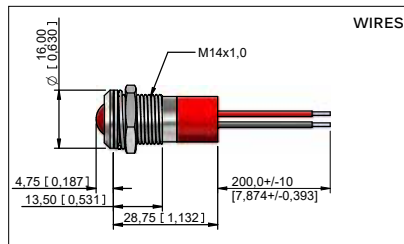
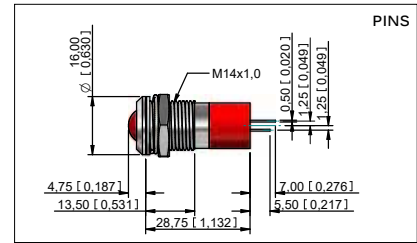
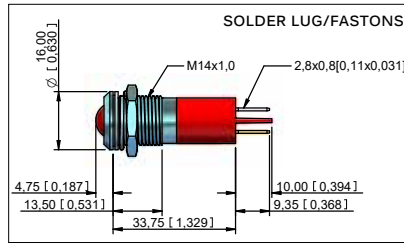

### FLUSH BEZEL

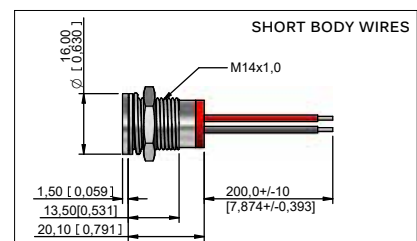
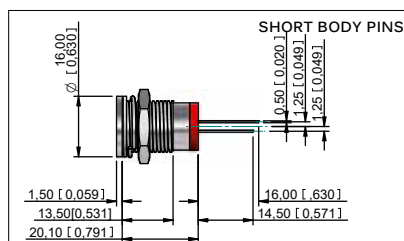
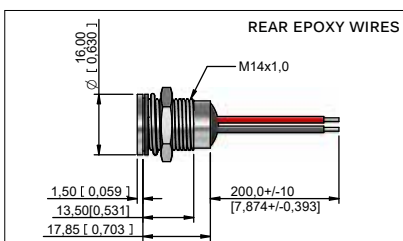
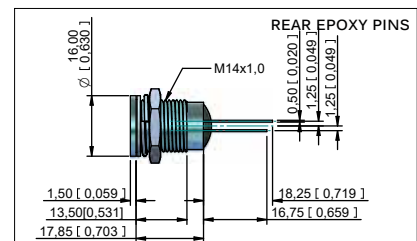
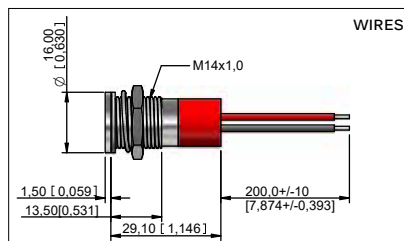
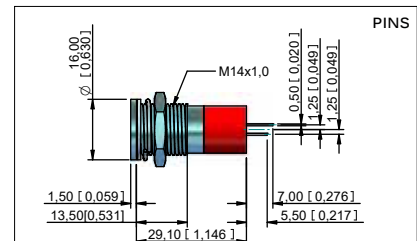
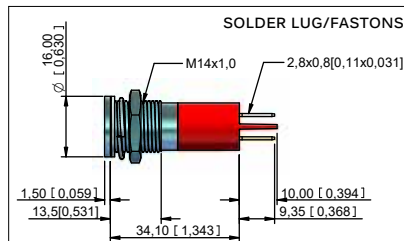

# Q SERIES Ø14mm (.551") Panel Mount LED Indicators

Custom options

## CUSTOM ENGRAVING



## Cable length & connector



For custom cable length and connectors please contact APEM

Suffix the part number with legend code (see example on page 4)

Code	Symbol	Description
-0AJ		High Beam
-097		Low Beam
-027		Rear Fog
-026		Front Fog
-021		Windscreen Wiper
-022		Windscreen Washer
-023		Ventilator Fan
-0AH		Turn Signal
-098		Side Lights

Code	Symbol	Description
-041		Horn
-013		Hazard Warning
-018		Heating
-0BU		Brake Test
-0K6		Arrow
-0AG		Battery
-0GP		Oil Can
-020		Windscreen Heating
-086		ABS

Code	Symbol	Description
-0EL		Engine Coil
-0SB		Seat Belt
-0UB		USB Connection
-0ST		Steam
-0EU		ECU
-0AD		Side Step
-012		Air Con
-040		Engine
-0BR		Boot/Trunk Release

Some common codes are listed above, for your custom requirements please contact APEM. Unless specified standard engraving with white infill will be supplied.



# Q SERIES Ø14mm (.551") Panel Mount LED Indicators

## Order Overview

### STANDARD OPTIONS

The Q14 Series is available with a range of standard options, to specify your LED, simply choose one option from each column. An example is shown below.

Q	14	P	1	C	XX	B	28	E
SERIES	MOUNTING HOLE	BEZEL STYLE	TERMINALS	BEZEL FINISH	TYPE OF ILLUMINATION	LED COLOR	VOLTAGE	SEALING
Q	14 = Ø14mm	P = Prominent F = Flush	1 = Solder Lug/ Fastons (2.8 x 0.8) 2 = Pins 3 = Wires 4 = Rear epoxy Pins 5 = Rear epoxy Wires 6 = Short body Pins 7 = Short body Wires	C = Bright Chrome B = Black Chrome G = Satin Grey	XX = Fixed Light KK = Flashing Light (12- 28VDC) YY = Bi-color ZZ = Tri-color	R = Red G = Green Y = Yellow B = Blue W = White O = Orange HR = Hyper Bright Red HG = Hyper Bright Green HY = Hyper Bright Yellow HO = Hyper Bright Orange SR = Super Bright Red SG = Super Bright Green SY = Super Bright Yellow SB = Super Bright Blue SW = Super Bright White RG = Red/Green RY = Red/Yellow GY = Green/Yellow RYG = Red/Yellow/Green	02 = no resistor* 06 = 6VDC 12 = 12VDC 12A = 12VAC/DC 24 = 24VDC 24A = 24VAC/DC 28 = 28VDC 28A = 28VAC/DC 110 = 110VAC 220 = 220VAC	(Blank) = Unsealed E = IP67

#### Example Q14F3CXXR12E-0SB

Ø14mm, Flush bezel, wire termination, red LED  
bright chrome finish, fixed light,  
12VDC LED, IP67 panel sealed,  
engraved with seat belt symbol (see page 3)



- Gold Faston terminal denotes Anode (+), silver terminal denotes Cathode (-)
- Standard wire length is 200mm, 22AWG UL1007, red wire denotes Anode (+), black wire denotes Cathode (-) for other wire lengths consult APEM
- For LEDs with alternative voltages consult APEM
- Bi-color LEDs, by connecting the gold Faston (+) one color is produced, by reversing the supply voltage another color is produced – Bi-colors are available up to 28VDC
- Take care when soldering to the Faston terminals (recommended solder temperature 270°C - 2 sec)
- Short body pins and wires are only available up to 28VDC
- The Tri-color LED has red and green LEDs when both are connected yellow is produced
- Standard Tri-color Faston terminals are two Anodes (+) and one Cathode (-)
- Tri-color wires are one red (+) and one green (+) Anode and one black (-) Cathode
- Tri-color pins are center (-) Cathode, shortest (+) Anode pin green, longest (+) Anode pin red
- Maximum panel thickness 11mm
- We recommend using Hyperbright or Superbright LEDs for use at 110VAC and 220VAC
- For multi-voltage options please consult APEM

\* = For resistorless versions (02) please refer to the forward voltage

# Q16 SERIES

Ø16mm (.630") Panel Mount LED Indicators

---



## Distinctive features

Panel mount LED indicators with 10mm colored diffused epoxy lens or 10mm water clear super bright LEDs.

Custom engraving and secret until lit polycarbonate decals available

Bright chrome, black chrome or satin grey bezel finish.

Prominent and flush bezel styles. voltage: 2VDC - 220VAC.

Terminals: 2.8 x 0.8 solder lug/fastons, pins or 200mm long wires.

IP67 sealing option (EN60529). Supplied with fixing nut and spring washer.

## Typical Applications

Process Controls

Professional Electrical Appliances

Communications, Radar

Civil engineering vehicles, trucks, diggers, crane

Trains

HVAC, Energy Management

Lifts

Machine Tools

# Q SERIES Ø16mm (.630") Panel Mount LED Indicators

## Distinctive features and specification

### Features

- 16mm panel mounting LED indicator
- 10mm colored diffused epoxy lens or 10mm water clear super bright LEDs
- Plated brass bezel finished in bright chrome, black chrome or satin grey
- Secret until lit polycarbonate decals or custom engraving
- Prominent and flush bezel styles
- 2VDC – 220VAC
- (2.8 x 0.8) solder lug/faston terminals, pins or (200mm long) wire terminations
- IP67 sealing option (EN60529)
- Supplied with fixing nut and spring washer



NB: UL Recognized Component

### TECHNICAL SPECIFICATIONS

Voltage	Operating Voltage (Min to Max)	Operating Current (Typical All Types)
02 (No Resistor)	1.8 to 3.3VDC	20mA max*
6VDC	5.4 to 6.6VDC	20mA
12VDC	10.8 to 13.2VDC	20mA
24VDC	21.6 to 26.4VDC	20mA
28VDC	25.2 to 30.8VDC	20mA
110VAC	99 to 121VAC	6mA
220VAC	207 to 253VAC	3mA

Max Reverse Voltage: 5V

Viewing Angle: 30–100° (dependant on model)

Life Expectancy: 100,000 hours

Temperature Range: –40 to +85°C (operating & storage)

Torque: 75cNm

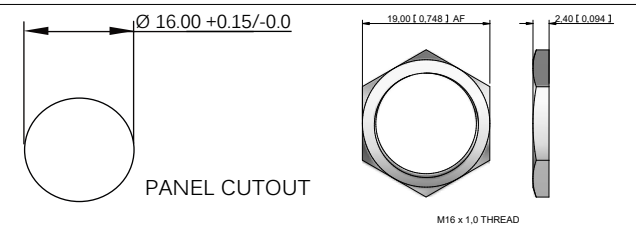

Standard LED Intensity	Prominent	Flush	Forward Voltage
HE Red	100mcd	10mcd	2.0V
Green	60mcd	5mcd	2.2V
Yellow	50mcd	4mcd	2.1V
Blue	540mcd	100mcd	3.3V
White	1000mcd	120mcd	3.3V
Orange	100mcd	200mcd	2.0V
Bi-color (Typical) (Red/Green)	15/15mcd	14/10mcd	2.0V/2.2V
Tri-color (Typical) (Red/Green/Yellow)	80/50/50mcd	180/30/30mcd	2.0V/2.2V/2.1V

Bi-color - The color is changed by reversing the polarity of the supply voltage.

Tri-color - The indicator has red and green LEDs, when both connected yellow is produced.

Super Bright LED	Prominent	Flush	Forward Voltage
HE Red	17,000mcd	2000mcd	2.2V
Green	4,100mcd	680mcd	3.5V
Yellow	2,500mcd	350mcd	2.3V
Blue	2,500mcd	300mcd	3.3V
White	4,400mcd	200mcd	3.3V
Orange	2,800mcd	300mcd	2.1V

Hyper Bright LED	Prominent	Flush	Forward Voltage
HE Red	2,800mcd	800mcd	2.1V
Green	2,200mcd	250mcd	3.2V
Yellow	1,300mcd	250mcd	2.0V
Orange	850mcd	200mcd	2.1V

Luminous intensity will be reduced with lower operating current.

Note: The operating voltage must not be exceeded by more than 10% as this will result in reduced life expectancy.

The company reserves the right to change specifications without notice.

\* Customer to supply resistor for desired operating current.

Luminous intensity is measured at 20mA on a discrete LED unless otherwise stated.

Luminous intensities and color shades of white LEDs may vary within a batch.

# Q SERIES Ø16mm (.630") Panel Mount LED Indicators

## Technical Drawings

### PROMINENT BEZEL

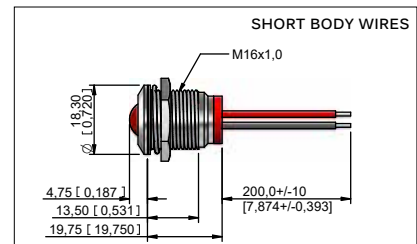
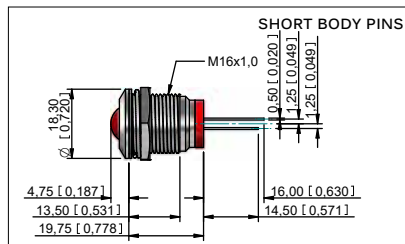
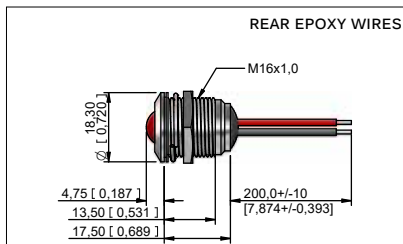
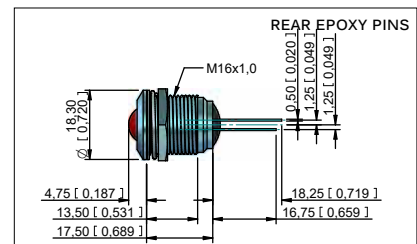
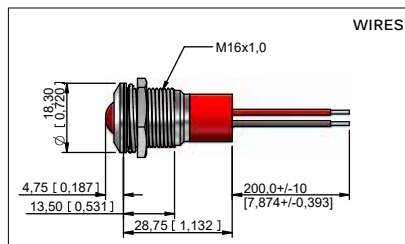
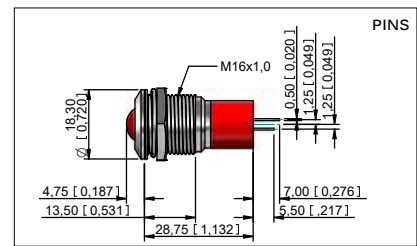
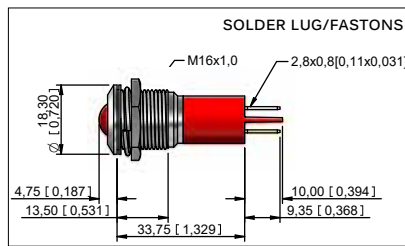

### FLUSH BEZEL

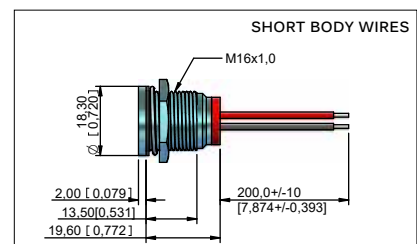
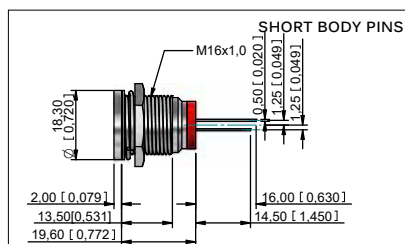
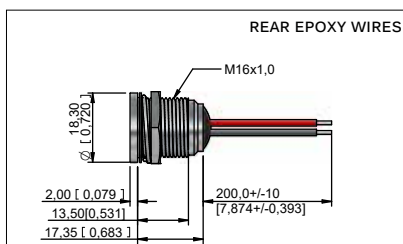
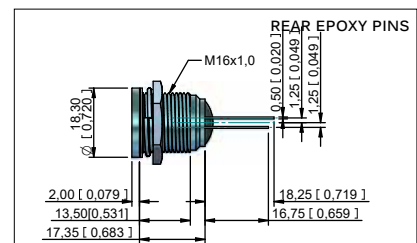
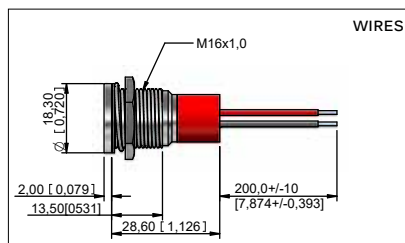
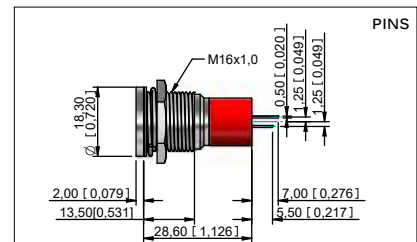
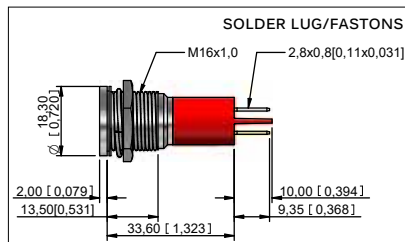

# Q SERIES Ø16mm (.630") Panel Mount LED Indicators

Custom options

## Secret Until Lit Polycarbonate Inserts



Suffix the part number with legend code (see example on page 5)

Code	Symbol	Description
-3AH		Turn Signal
-313		Hazard
-3GP		Oil can
-3AG		Battery
-327		Rear fog
-397		Low beam
-3BU		Brake test
-3K6		Arrow
-3AJ		High beam

Code	Symbol	Description
-3PB		Park Brake
-398		Side Lights
-3SB		Seat Belt
-3TP		Tyre Pressure
-3CE		Check Engine
-3EC		Engine Temperature
-3FP		Fuel
-3BF		Brake Failure

Some common codes are listed above, for your custom requirements please contact APEM.

# Q SERIES Ø16mm (.630") Panel Mount LED Indicators

Custom options

## Custom Engraving



## Cable length & connector



For custom cable length and connectors please contact APEM

Suffix the part number with legend code (see example on page 5)

Code	Symbol	Description
-0AJ		High Beam
-097		Low Beam
-027		Rear Fog
-026		Front Fog
-021		Windscreen Wiper
-022		Windscreen Washer
-023		Ventilator Fan
-0AH		Turn Signal
-098		Side Lights

Code	Symbol	Description
-041		Horn
-013		Hazard Warning
-018		Heating
-0BU		Brake Test
-0K6		Arrow
-0AG		Battery
-0GP		Oil Can
-020		Windscreen Heating
-086		ABS

Code	Symbol	Description
-0EL		Engine Coil
-0SB		Seat Belt
-0UB		USB Connection
-0ST		Steam
-0EU		ECU
-0AD		Side Step
-012		Air Con
-040		Engine
-0BR		Boot/Trunk Release

Some common codes are listed above, for your custom requirements please contact APEM. Unless specified standard engraving with white infill will be supplied.



# Q SERIES Ø16mm (.630") Panel Mount LED Indicators

## Overview

### STANDARD OPTIONS

The Q16 Series is available with a range of standard options, to specify your LED, simply choose one option from each column. An example is shown below.

Q	16	F	1	G	XX	Y	24	E
SERIES	MOUNTING HOLE	BEZEL STYLE	TERMINALS	BEZEL FINISH	TYPE OF ILLUMINATION	LED COLOR	VOLTAGE	SEALING
Q	16 = Ø16mm	Metal P = Prominent F = Flush Plastic PP = Prominent FP = Flush	1 = Solder Lug/ Fastons (2.8 x 0.8) 2 = Pins 3 = Wires 4 = Rear epoxy Pins 5 = Rear epoxy Wires 6 = Short body Pins 7 = Short body Wires	Metal C = Bright Chrome B = Black Chrome G = Satin Grey Plastic CP = Bright BP = Black GP = Satin Grey AU = Gold	XX = Fixed Light KK = Flashing Light (12 - 28VDC) YY = Bi-color ZZ = Tri-color	R = Red G = Green Y = Yellow B = Blue W = White O = Orange HR = Hyper Bright Red HG = Hyper Bright Green HY = Hyper Bright Yellow HO = Hyper Bright Orange SR = Super Bright Red SG = Super Bright Green SY = Super Bright Yellow SB = Super Bright Blue SW = Super Bright White RG = Red/Green RY = Red/Yellow GY = Green/Yellow RYG = Red/Yellow/Green	02 = no resistor* 06 = 6VDC 12 = 12VDC 12A = 12VAC/DC 24 = 24VDC 24A = 24VAC/DC 28 = 28VDC 28A = 28VAC/DC 110 = 110VAC 220 = 220VAC	(Blank) = Unsealed E = IP67

#### Example Q16F7BXXHR12E-3PB

Ø16mm, flush metal bezel, wire terminals  
Matt black chrome finish, fixed light,  
Red, 12VDC LED, IP67 panel sealed  
Secret until lit Park Brake Symbol (see page 3)



- Gold Faston terminal denotes Anode (+), silver terminal denotes Cathode (-)
- Standard wire length is 200mm, 22AWG UL1007, red wire denotes Anode (+), black wire denotes Cathode (-) for other wire lengths consult APEM
- For LEDs with alternative voltages consult APEM
- Bi-color LEDs, by connecting the gold Faston (+) one color is produced, by reversing the supply voltage another color is produced – Bi-colors are available up to 28VDC
- Take care when soldering to the Faston terminals (recommended solder temperature 270°C - 2 sec)
- Short body pins and wires are only available up to 28VDC
- The Tri-color LED has red and green LEDs when both are connected yellow is produced
- Standard Tri-color Faston terminals are two Anodes (+) and one Cathode (-)
- Tri-color wires are one red (+) and one green (+) Anode and one black (-) Cathode
- Tri-color pins are center (-) Cathode, shortest (+) Anode pin green, longest (+) Anode pin red
- Maximum panel thickness 11mm
- We recommend using Hyperbright or Superbright LEDs for use at 110VAC and 220VAC
- For multi-voltage options please consult APEM

\* = For resistorless versions (02) please refer to the forward voltage

# Q19 SERIES

Ø19mm (.748") Panel Mount LED Indicators

---



## Distinctive features

Panel mount LED indicators with 10mm colored diffused epoxy lens or 10mm water clear super bright LEDs.

Bright chrome, black chrome or satin grey bezel finish.

Prominent and flush bezel styles. voltage: 2VDC - 220VAC.

Terminals: 2.8 x 0.8 solder lug/fastons, pins or 200mm long wires.

IP67 sealing option (EN60529). Supplied with fixing nut and spring washer.

## Typical Applications

Process Controls

Professional Electrical Appliances

Communications, Radar

Civil engineering vehicles, trucks, diggers, crane

Trains

HVAC, Energy Management

Lifts

Machine Tools

# Q SERIES Ø19mm (.748") Panel Mount LED Indicators

## Distinctive features and specification

VOYC1511US

### Features

- 19mm panel mounting LED indicator
- 10mm colored diffused epoxy lens or 10mm water clear super bright LEDs
- Plated brass bezel finished in bright chrome, black chrome or satin grey
- Prominent and flush bezel styles
- Custom engraving available
- 2VDC – 220VAC
- (2.8 x 0.8) solder lug/faston terminals, pins or (200mm long) wire terminations
- IP67 sealing option (EN60529)
- Supplied with fixing nut and spring washer



NB: UL Recognized Component

### TECHNICAL SPECIFICATIONS

Voltage	Operating Voltage (Min to Max)	Operating Current (Typical All Types)
02 (No Resistor)	1.8 to 3.3VDC	20mA max*
6VDC	5.4 to 6.6VDC	20mA
12VDC	10.8 to 13.2VDC	20mA
24VDC	21.6 to 26.4VDC	20mA
28VDC	25.2 to 30.8VDC	20mA
110VAC	99 to 121VAC	6mA
220VAC	207 to 253VAC	3mA

Max Reverse Voltage: 5V

Viewing Angle: 30–100° (dependant on model)

Life Expectancy: 100,000 hours

Temperature Range: –40 to +85°C (operating & storage)

Torque: 75cNm

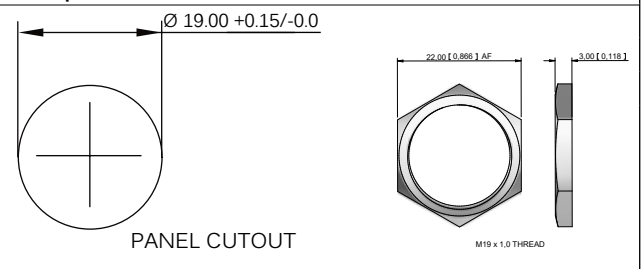

Standard LED Intensity	Prominent	Flush	Forward Voltage
HE Red	100mcd	10mcd	2.0V
Green	60mcd	5mcd	2.2V
Yellow	50mcd	4mcd	2.1V
Blue	540mcd	100mcd	3.3V
White	1000mcd	120mcd	3.3V
Orange	100mcd	200mcd	2.0V
Bi-color (Typical) (Red/Green)	15/15mcd	14/10mcd	2.0V/2.2V
Tri-color (Typical) (Red/Green/Yellow)	80/50/50mcd	180/30/30mcd	2.0V/2.2V/2.1V

Bi-color - The color is changed by reversing the polarity of the supply voltage.

Tri-color - The indicator has red and green LEDs, when both connected yellow is produced.

Super Bright LED	Prominent	Flush	Forward Voltage
HE Red	17,000mcd	2000mcd	2.2V
Green	4,100mcd	680mcd	3.5V
Yellow	2,500mcd	350mcd	2.3V
Blue	2,500mcd	300mcd	3.3V
White	4,400mcd	300mcd	3.3V
Orange	2,800mcd	300mcd	2.1V

Hyper Bright LED	Prominent	Flush	Forward Voltage
HE Red	2,800mcd	800mcd	2.1V
Green	2,200mcd	250mcd	3.2V
Yellow	1,300mcd	250mcd	2.0V
Orange	850mcd	200mcd	2.1V

Luminous intensity will be reduced with lower operating current.

Note: The operating voltage must not be exceeded by more than 10% as this will result in reduced life expectancy.  
The company reserves the right to change specifications without notice.

\* Customer to supply resistor for desired operating current.  
Luminous intensity is measured at 20mA on a discrete LED unless otherwise stated.  
Luminous intensities and color shades of white LEDs may vary within a batch.

# Q SERIES Ø19mm (.748") Panel Mount LED Indicators

## Technical Drawings

### PROMINENT BEZEL

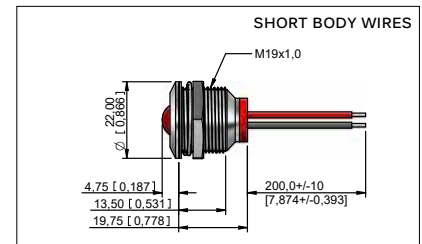
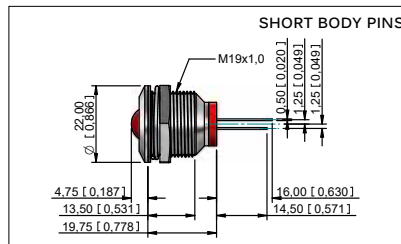
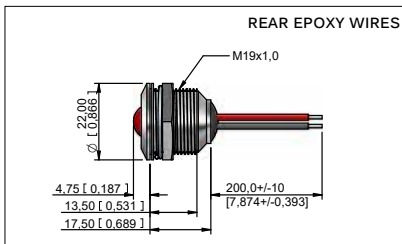
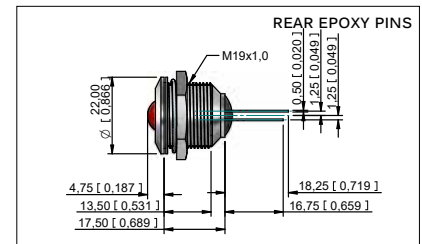
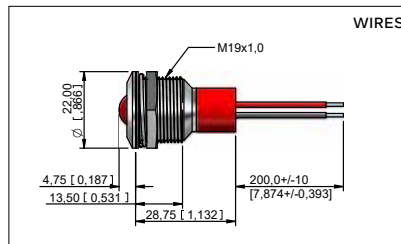
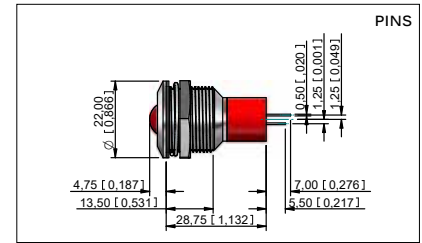
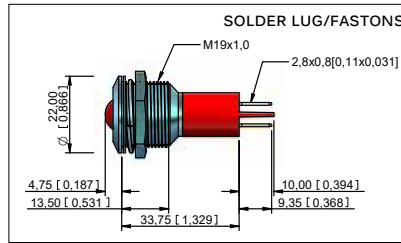

### FLUSH BEZEL

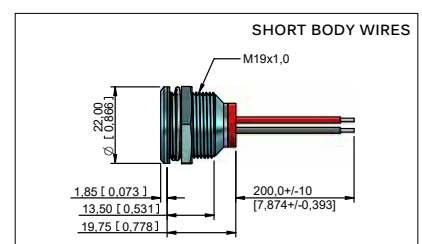
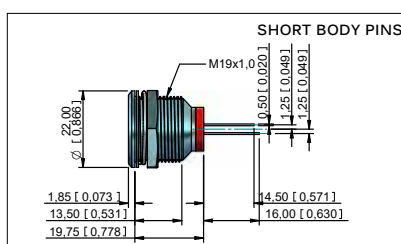
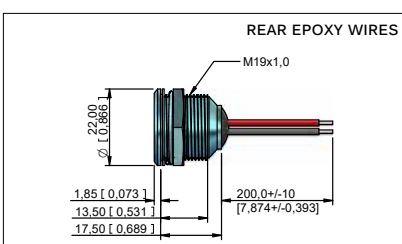
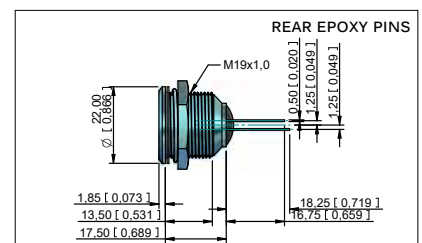
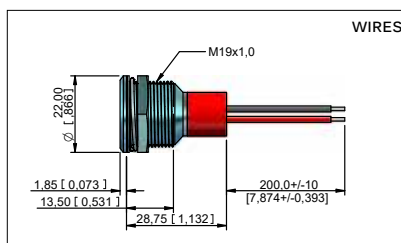
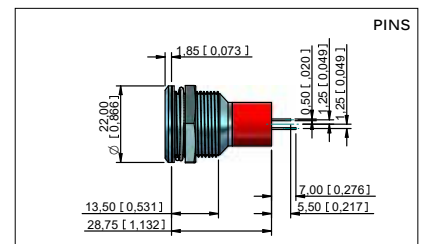
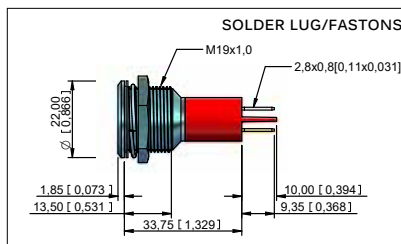

# Q SERIES Ø19mm (.748") Panel Mount LED Indicators

Custom options

## CUSTOM ENGRAVING



## Cable length & connector



For custom cable length and connectors please contact APEM

Suffix the part number with legend code

Code	Symbol	Description
-0AJ		High Beam
-097		Low Beam
-027		Rear Fog
-026		Front Fog
-021		Windscreen Wiper
-022		Windscreen Washer
-023		Ventilator Fan
-0AH		Turn Signal
-098		Side Lights

Code	Symbol	Description
-041		Horn
-013		Hazard Warning
-018		Heating
-0BU		Brake Test
-0K6		Arrow
-0AG		Battery
-0GP		Oil Can
-020		Windscreen Heating
-086		ABS

Code	Symbol	Description
-0EL		Engine Coil
-0SB		Seat Belt
-0UB		USB Connection
-0ST		Steam
-0EU		ECU
-0AD		Side Step
-012		Air Con
-040		Engine
-0BR		Boot/Trunk Release

Some common codes are listed above, for your custom requirements please contact APEM. Unless specified standard engraving with white infill will be supplied.

# Q SERIES Ø19mm (.748") Panel Mount LED Indicators

## Overview

### STANDARD OPTIONS

The Q19 Series is available with a range of standard options, to specify your LED, simply choose one option from each column. An example is shown below.

Q	19	P	1	B	XX	G	12	E
SERIES	MOUNTING HOLE	BEZEL STYLE	TERMINALS	BEZEL FINISH	TYPE OF ILLUMINATION	LED COLOR	VOLTAGE	SEALING
Q	19 = Ø19mm	Metal P = Prominent F = Flush	1 = Solder Lug/ Fastons (2.8 x 0.8) 2 = Pins 3 = Wires 4 = Rear epoxy Pins 5 = Rear epoxy Wires 6 = Short body Pins 7 = Short body Wires	Metal C = Bright Chrome B = Black Chrome G = Satin Grey	XX = Fixed Light KK = Flashing Light (12 - 28VDC) YY = Bi-color ZZ = Tri-color	R = Red G = Green Y = Yellow B = Blue W = White O = Orange  HR = Hyper Bright Red HG = Hyper Bright Green HY = Hyper Bright Yellow HO = Hyper Bright Orange  SR = Super Bright Red SG = Super Bright Green SY = Super Bright Yellow SB = Super Bright Blue SW = Super Bright White  RG = Red/Green RY = Red/Yellow GY = Green/Yellow  RYG = Red/Yellow/Green	02 = no resistor* 06 = 6VDC 12 = 12VDC 12A = 12VAC/DC 24 = 24VDC 24A = 24VAC/DC 28 = 28VDC 28A = 28VAC/DC 110 = 110VAC 220 = 220VAC	(Blank) = Unsealed E = IP67

#### Example Q19P1BXXR12E

Ø19mm, prominent bezel, solder lug terminals, black chrome finish, fixed light, red, 12VDC LED, IP67 panel sealed



- Gold Faston terminal denotes Anode (+), silver terminal denotes Cathode (-)
- Standard wire length is 200mm, 22AWG UL1007, red wire denotes Anode (+), black wire denotes Cathode (-) for other wire lengths consult APEM
- For LEDs with alternate voltages consult APEM
- Bi-color LEDs, by connecting the gold Faston (+) one color is produced, by reversing the supply voltage another color is produced – Bi-colors are available up to 28VDC
- Take care when soldering to the Faston terminals (recommended solder temperature 270°C - 2 sec)
- Short body pins and wires are only available up to 28VDC
- The Tri-color LED has red and green LEDs when both are connected yellow is produced
- Standard Tri-color Faston terminals are two Anodes (+) and one Cathode (-)
- Tri-color wires are one red (+) and one green (+) Anode and one black (-) Cathode
- Tri-color pins are center (-) Cathode, shortest (+) Anode pin green, longest (+) Anode pin red
- Maximum panel thickness 11mm
- We recommend using Hyperbright or Superbright LEDs for use at 110VAC and 220VAC
- For multi-voltage options please consult APEM

\* = For resistorless versions (02) please refer to the forward voltage



# Q22 SERIES

Ø22mm (.866") Panel Mount LED Indicators

---



## Distinctive features

Panel mount LED indicators with 18mm colored diffused epoxy lens.

Custom engraving available.

Metal bezel finish: bright chrome, black chrome or satin grey.

Plastic bezel finished in black.

Prominent and flush bezel styles. Voltage: 5.5VDC - 220VAC.

Terminals: 2.8 x 0.8 solder lug/fastons, pins or 200mm long wires.

IP67 sealing option (EN60529). Supplied with fixing nut and spring washer.

## Typical Applications

Process Controls

Professional Electrical Appliances

Communications, Radar

Civil engineering vehicles, trucks, diggers, crane

Trains

HVAC, Energy Management

Lifts

Machine Tool

# Q SERIES Ø22mm (.866") Panel Mount LED Indicators

## Distinctive features and specification

### Features

- 22mm panel mounting LED indicator
- 18mm colored diffused epoxy lens or 18mm super bright LEDs
- Plated brass bezel finished in bright chrome, black chrome or satin grey
- Black ABS Plastic bezel option
- Prominent and flush bezel styles
- Custom engraving available
- (2.8 x 0.8) solder lug/faston terminals, pins or (200mm long) wire terminations
- IP67 sealing option (EN60529)
- Supplied with fixing nut and spring washer



NB: UL Recognized Component

### TECHNICAL SPECIFICATIONS

Voltage	Operating Voltage (Min to Max)	Operating Current (Typical All Types)
05 (No Resistor)	3.3 to 9.9VDC	40mA max*
12VDC	10.8 to 13.2VDC	40mA
24VDC	21.6 to 26.4VDC	40mA
28VDC	25.2 to 30.8VDC	40mA
110VAC	99 to 121VAC	5mA
220VAC	207 to 253VAC	3mA

**Max Reverse Voltage:** 5V

**Viewing Angle:** 30–100° (dependant on model)

**Life Expectancy:** 100,000 hours

**Temperature Range:** –40 to +85°C (operating & storage)

**Torque:** 100cNm

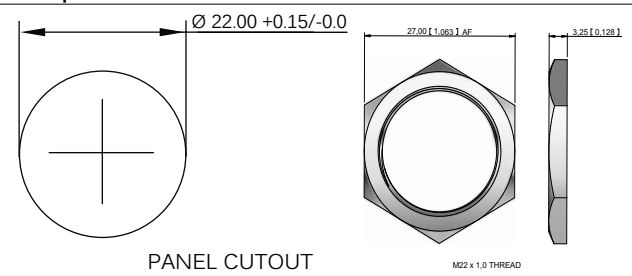

Standard LED Intensity	Prominent	Flush	Forward Voltage
HE Red	80mcd	70mcd	5.7V
Green	95mcd	33mcd	6.0V
Yellow	60mcd	29mcd	5.9V
Blue	120mcd	100mcd	9.9V
White	350mcd	120mcd	3.3V
Bi-color (Typical) (Red/Green)	80/50mcd	80/50mcd	2.0V/2.2V
Tri-color (Typical) (Red/Green/Yellow)	80/50/50mcd	80/50/50mcd	2.0V/2.2V/2.1V

Bi-color - The color is changed by reversing the polarity of the supply voltage.

Tri-color - The indicator has red and green LEDs, when both connected yellow is produced.

Super bright LED (Diffused)	Prominent	Flush	Forward Voltage
HE Red	930mcd	700mcd	5.7V
Green	1,060mcd	980mcd	9.0V
Yellow	1,780mcd	1,250mcd	6.0V

Luminous intensity will be reduced with lower operating current.

Note: The operating voltage must not be exceeded by more than 10% as this will result in reduced life expectancy.

The company reserves the right to change specifications without notice.

\* Customer to supply resistor for desired operating current.

Luminous intensity is measured at 20mA on a discrete LED unless otherwise stated.

Luminous intensities and color shades of white LEDs may vary within a batch.

# Q SERIES Ø22mm (.866") Panel Mount LED Indicators

## Technical Drawings

### PROMINENT BEZEL

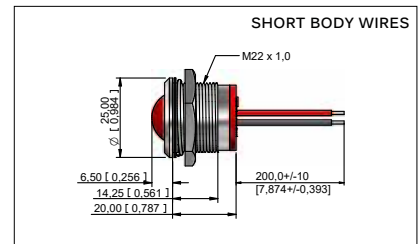
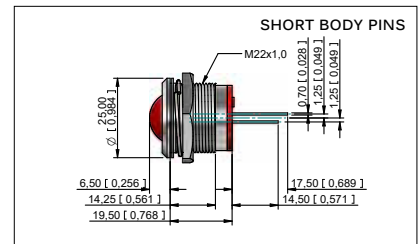
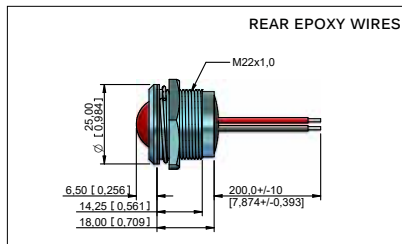
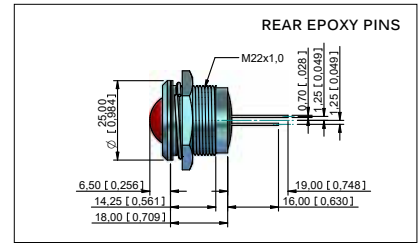
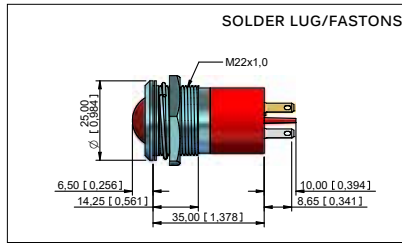

### FLUSH BEZEL

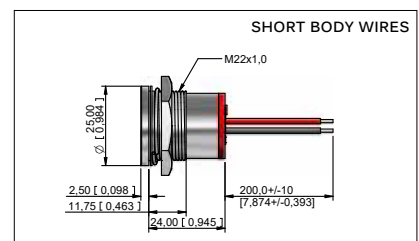
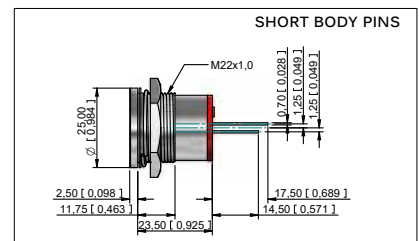
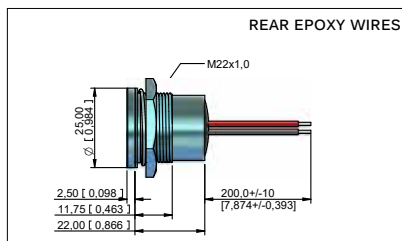
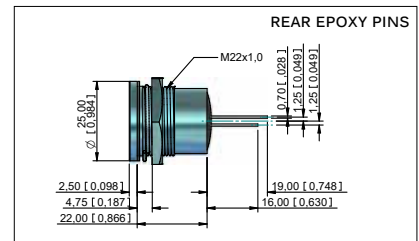
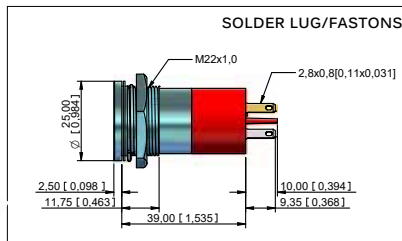

# Q SERIES Ø22mm (.866") Panel Mount LED Indicators

## Custom Options

### Custom Engraving



### Cable length & connector



For custom cable length and connectors please contact APEM

Suffix the part number with legend code (see example on page 4)

Code	Symbol	Description
-0AJ		High Beam
-097		Low Beam
-027		Rear Fog
-026		Front Fog
-021		Windscreen Wiper
-022		Windscreen Washer
-023		Ventilator Fan
-0AH		Turn Signal
-098		Side Lights

Code	Symbol	Description
-041		Horn
-013		Hazard Warning
-018		Heating
-0BU		Brake Test
-0K6		Arrow
-0AG		Battery
-0GP		Oil Can
-020		Windscreen Heating
-086		ABS

Code	Symbol	Description
-0BD		Engine Coil
-0SB		Seat Belt
-0UB		USB Connection
-0ST		Steam
-0EU		ECU
-0AD		Side Step
-012		Air Con
-040		Engine
-0BR		Boot/Trunk Release

Some common codes are listed above, for your custom requirements please contact APEM. Unless specified standard engraving with white infill will be supplied

# Q SERIES Ø22mm (.866") Panel Mount LED Indicators

## Overview

### STANDARD OPTIONS

The Q22 Series is available with a range of standard options, to specify your LED, simply choose one option from each column. An example is shown below.

Q	22	F	1	BP	XX	W	28	E	DL
SERIES	MOUNTING HOLE	BEZEL STYLE	TERMINALS	BEZEL FINISH	TYPE OF ILLUMINATION	LED COLOR	VOLTAGE	SEALING	OPTIONS
Q	22 = Ø22mm	Metal P = Prominent F = Flush Plastic PP = Prominent FP = Flush	1 = Solder Lug/Fastons (2.8 x 0.8) 4 = Rear epoxy Pins 5 = Rear epoxy Wires 6 = Short body Pins 7 = Short body Wires	Metal C = Bright Chrome B = Black Chrome G = Satin Grey Plastic BP = Black Anodised Flush AR = Red AG = Green AY = Yellow AB = Blue	XX = Fixed Light KK = Flashing Light (only 12VDC) YY = Bi-color ZZ = Tri-color	R = Red G = Green Y = Yellow B = Blue W = White SR = Super bright Red SG = Super bright Green SY = Super bright Yellow RG = Red/Green RY = Red/Yellow GY = Green/Yellow RYG = Red/Yellow/Green	05 = no resistor* 12 = 12VDC 12A = 12VAC/DC 24 = 24VDC 24A = 24VAC/DC 28 = 28VDC 28A = 28VAC/DC 110 = 110VAC 220 = 220VAC	(Blank) = Unsealed E = IP67	DL = Daisy Chain LT = Lamp Test

#### Example Q22F5CXXG12E-0AG

Ø22mm, flush bezel, rear epoxy wire terminals, bright chrome finish, fixed light, green, 12VDC LED, IP67 panel sealed, Battery symbol marking



- Gold Faston terminal denotes Anode (+), silver terminal denotes Cathode (-)
- Standard wire length is 200mm, 22AWG UL1007, red wire denotes Anode (+), black wire denotes Cathode (-) for other wire lengths consult APEM
- For LEDs with alternative voltages consult APEM
- Bi-color LEDs, by connecting the gold Faston (+) one color is produced, by reversing the supply voltage another color is produced – Bi-colors are available up to 28VDC
- Take care when soldering to the Faston terminals (recommended solder temperature 270°C - 2 sec)
- Pin and Wire options are epoxy sealed at the rear of the bezels, termination options 4 and 5
- The Tri-color LED has red and green LEDs when both are connected yellow is produced
- Standard Tri-color Faston terminals are two Anodes (+) and one Cathode (-)
- Tri-color wires are one red (+) and one green (+) Anode and one black (-) Cathode
- Tri-color pins are center (-) Cathode, shortest (+) Anode pin green, longest (+) Anode pin red
- Maximum panel thickness: Prominent = 12mm, Flush = 10mm
- Plastic bezel material: ABS
- Daisy chaining option - has negative (Cathode) terminals linked (3 x Fastons), solder lugs only
- Lamp test facility option 4 x solder lug/Faston only
- We recommend using super bright LEDs for use at 110 and 220VAC

\* = For resistorless versions (05) please refer to the forward voltage

# QRM6 SERIES

Ø6mm (.236") Rear Panel Mount LED Indicators

---



## Distinctive features

Rear panel mount LED indicators with 3mm colored diffused epoxy lens or 3mm water clear super bright LEDs.

Black chrome finish.

Voltage: 2VDC - 28VDC.

Terminals: Pins or 200mm long wires.

IP67 sealing option (EN60529).

Supplied with fixing nut and spring washer.

## Typical Applications

Process Controls

Professional Electrical Appliances

Communications, Radar

Civil engineering vehicles, trucks, diggers, crane

Trains

HVAC, Energy Management

Lifts

Machine Tools



# QRM6 SERIES Rear Panel Mount LED Indicators

Distinctive features and specifications

## Features

- Ø6mm rear mounting LED indicator
- 3mm flush diffused LED, standard, hyper bright or water clear
- Bi-color LED options
- Black chrome finish
- 2VDC – 28VAC.DC
- 200mm wires or pin terminations
- IP67 sealed (EN60529)
- Epoxy sealed rear end
- Supplied with fixing nut, spring washer and O-ring



NB: UL Recognized Component

## TECHNICAL SPECIFICATIONS

Voltage	Operating Voltage (Min to Max)	Operating Current (Typical All Types)
02 (No Resistor)	1.8 to 3.8VDC	20mA max*
6VDC	5.4 to 6.6VDC	20mA
12VDC	10.8 to 13.2VDC	20mA
24VDC	21.6 to 26.4VDC	20mA
28VDC	25.2 to 30.8VDC	20mA

Max Reverse Voltage: 5V
Viewing Angle: 60°
Life Expectancy: 100,000 hours
Operating Temperature Range: -40 to +85°C
Storage Temperature Range: -55 to +100°C
Max panel thickness: 3.5mm
Torque: 60cNm

Materials	
Body: Black chrome plated brass	Lock washer: Spring steel
Nut: Black chrome plated brass	Terminal seal: Epoxy
Panel seal: Nitrile O-ring	Wires: 24AWG to UL1061

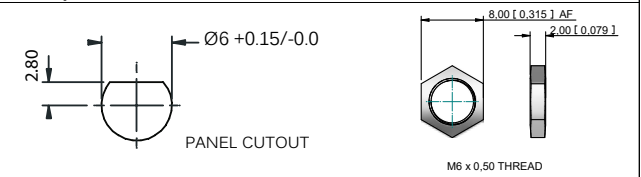

Standard LED Intensity	MCD Output (all voltages)	Forward Voltage
HE Red	10mcd	2.0V
Green	8mcd	2.2V
Yellow	6mcd	2.1V
Blue	100mcd	3.8V
White	220mcd	3.8V
Bi-color (Typical) (Red/Green)	10/8mcd	2.0V/2.2V

The color is changed by reversing the polarity of the supply voltage.

Super Bright	MCD Output (all voltages)	Forward Voltage
HE Red	500mcd	2.2V
Green	350mcd	3.5V
Yellow	140mcd	2.3V
Blue	200mcd	3.3V
White	350mcd	3.3V
Orange	500mcd	2.2V

Hyper Bright	MCD Output (all voltages)	Forward Voltage
HE Red	600mcd	2.2V
Green	350mcd	3.2V
Yellow	140mcd	2.0V

Luminous intensity will be reduced with lower operating current.

Note: The operating voltage must not be exceeded by more than 10% as this will result in reduced life expectancy.  
The company reserves the right to change specifications without notice.

\* Customer to supply resistor for desired operating current.  
Luminous intensity is measured at 20mA on a discrete LED unless otherwise stated.  
Luminous intensities and color shades of white LEDs may vary within a batch.

# QRM6 SERIES Rear Panel Mount LED Indicators

## Technical Drawings



Pins

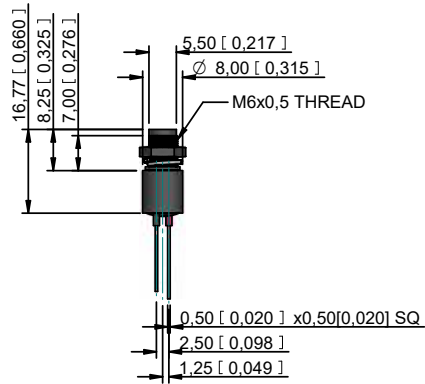

Wires

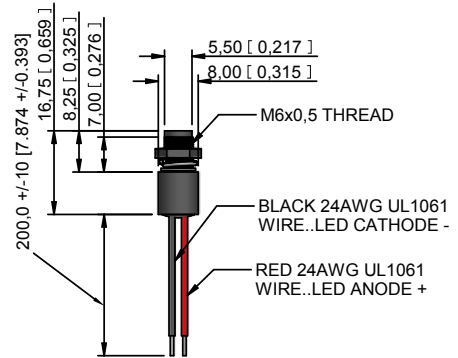

# QRM6 SERIES Rear Panel Mount LED Indicators

## Overview

### STANDARD OPTIONS

The QRM Series is available with a range of standard options, to specify your LED, simply choose one option from each column. An example is shown below.

SERIES	MOUNTING HOLE	TERMINALS	BEZEL FINISH	TYPE OF ILLUMINATION	LED COLOR	VOLTAGE	SEALING
QRM	6 = Ø6mm	4 = Pins 5 = Wires	B = Black Chrome	XX = Fixed light YY = Bi-color	R = Red G = Green Y = Yellow B = Blue W = White  HR = Hyper Bright Red HG = Hyper Bright Green HY = Hyper Bright Yellow  SR = Super Bright Red SG = Super Bright Green SY = Super Bright Yellow SB = Super Bright Blue SW = Super Bright White SO = Super Bright Orange  RG = Red/Green RY = Red/Yellow GY = Green/Yellow	02 = no resistor* 06 = 6VDC 12 = 12VDC 24 = 24VDC 28 = 28VDC	E = IP67 (Standard)

#### Example QRM64BXXR24E

Ø6mm mounting hole with pin terminations, black chrome finish, fixed light, Red 24VDC, panel sealed to IP67



- Standard wire length is 200mm, 24AWG UL1061, red wire denotes Anode (+), black wire denotes Cathode (-) for other wire lengths consult APEM
- For LEDs with alternate voltages consult APEM
- Bi-color LEDs, by connecting the gold Faston (+) one colour is produced, by reversing the supply voltage another colour is produced – Bi-colours are available up to 28VDC
- Take care when soldering (recommended solder temperature 270°C - 2 sec)
- Maximum panel thickness 3.5mm
- For multi-voltage options please consult APEM

\* = For resistorless versions (02) please refer to the forward voltage

# QRM8 SERIES

Ø8mm (.315") Rear Panel Mount LED Indicators

---



## Distinctive features

Rear panel mount LED indicators with 5mm colored diffused epoxy lens or 5mm water clear super bright LEDs.

Black chrome finish.

Voltage: 2VDC - 28VAC/DC

Pins or 200mm long wires.

IP67 sealing option (EN60529). Supplied with fixing nut and spring washer.

## Typical Applications

Medical

Telecommunications

Engineering

Transport Systems

Special Vehicles

Agricultural Vehicles

# QRM8 SERIES Rear Panel Mount LED Indicators

## Distinctive features and specifications

### Features

- Ø8mm rear mounting LED indicator
- 5mm flush diffused LED, standard, hyper bright or water clear
- Bi-color and Tri-color LED options
- Black chrome finish
- 2VDC – 28VAC/DC
- 200mm wires or pin terminations
- IP67 sealed (EN60529)
- Epoxy sealed rear end
- Supplied with fixing nut, spring washer and O-ring (Dress nut available as an option - contact APEM)



NB: UL Recognized Component

### TECHNICAL SPECIFICATIONS

Voltage	Operating Voltage (Min to Max)	Operating Current (Typical All Types)
02 (No Resistor)	1.8 to 3.8VDC	20mA max*
6VDC	5.4 to 6.6VDC	20mA
12VDC	10.8 to 13.2VDC	20mA
24VDC	21.6 to 26.4VDC	20mA
28VDC	25.2 to 30.8VDC	20mA

Max Reverse Voltage: 5V
Viewing Angle: 60°
Life Expectancy: 100,000 hours
Operating Temperature Range: -40 to +85°C
Storage Temperature Range: -55 to +100°C
Max panel thickness: 3.5mm
Torque: 60cNm

Materials	
<b>Body:</b> Black chrome plated brass	<b>Lock washer:</b> Spring steel
<b>Nut:</b> Black chrome plated brass	<b>Terminal seal:</b> Epoxy
<b>Panel seal:</b> Nitrile O-ring	<b>Wires:</b> 24AWG to UL1061



Standard LED Intensity	MCD Output (all voltages)	Forward Voltage
HE Red	12mcd	2.0V
Green	8mcd	2.2V
Yellow	6mcd	2.1V
Blue	200mcd	3.8V
White	500mcd	3.8V
Bi-color (Typical) (Red/Green)	15/10mcd	2.0V/2.2V
Tri-color (Typical) (Red/Green/Yellow)	15/10/6mcd	2.0V/2.2V/2.1V

Bi-color - the color is changed by reversing the polarity Tri-color - The indicator has red and green LEDs, when both connected yellow is produced.

Super Bright LED	MCD Output (all voltages)	Forward Voltage
HE Red	1300mcd	2.2V
Green	120mcd	3.3V
Yellow	350mcd	2.0V
Blue	280mcd	3.3V
White	350mcd	3.3V
Orange	500mcd	2.2V

Hyper Bright	MCD Output (all voltages)	Forward Voltage
HE Red	980mcd	2.2V
Green	300mcd	3.3V
Yellow	250mcd	2.0V

Luminous intensity will be reduced with lower operating current.

Note: The operating voltage must not be exceeded by more than 10% as this will result in reduced life expectancy.

The company reserves the right to change specifications without notice. \* Customer to supply resistor for desired operating current.

Luminous intensity is measured at 20mA on a discrete LED unless otherwise stated. Luminous intensities and color shades of white LEDs may vary within a batch.

# QRM8 SERIES Rear Panel Mount LED Indicators

## Technical Drawings

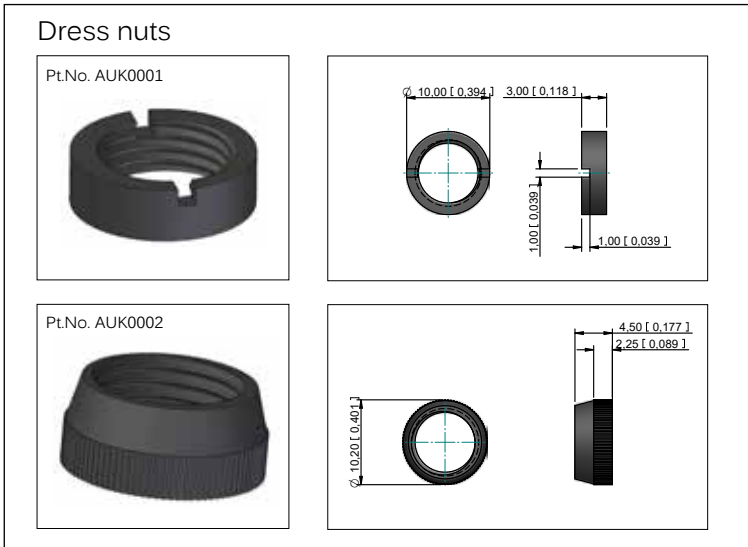
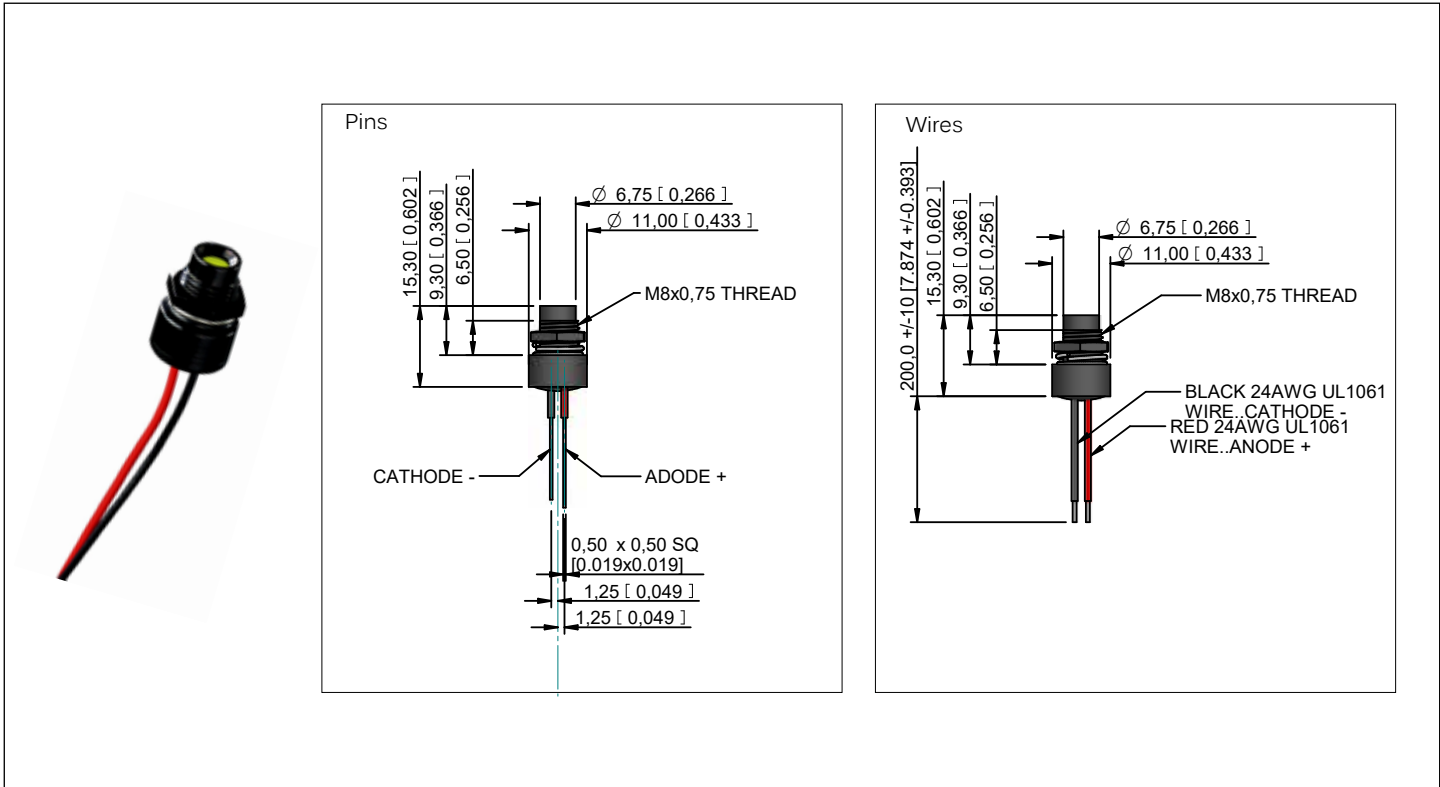



# QRM8 SERIES Rear Panel Mount LED Indicators

## Custom options

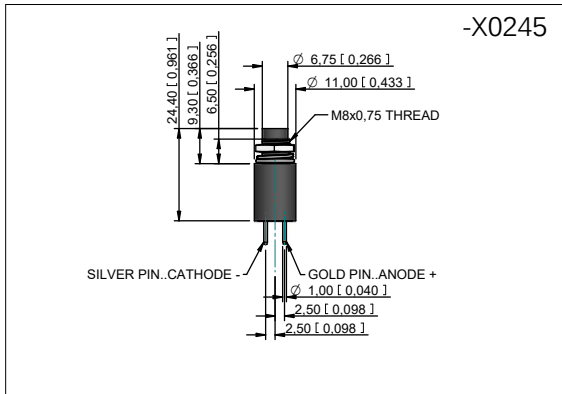

Fixed and Bi-color long body rigid pins

Long body matches the behind panel depth of APEM 12200X778 PCB mounting military grade toggle switches

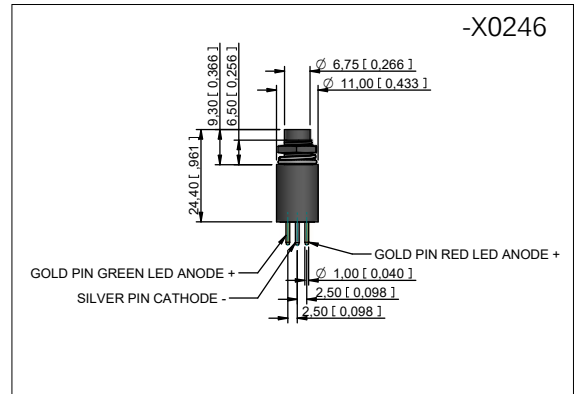

Tri-color long body and rigid PCB

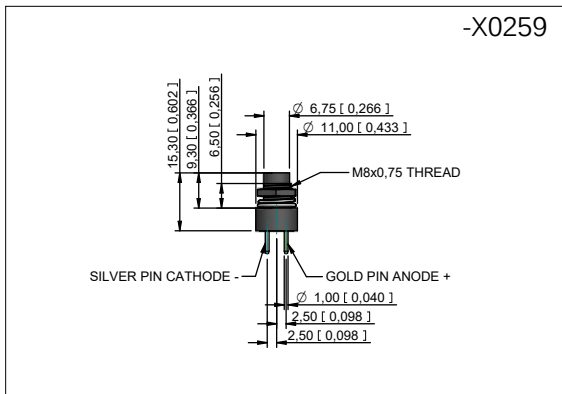

Fixed and Bi-color standard body rigid pins

To apply the above custom option, suffix the part number with the -X reference number  
**Example QRM84BXXHB24AE-X0245**

# QRM8 SERIES Rear Panel Mount LED Indicators

## Overview

### STANDARD OPTIONS

The QRM Series is available with a range of standard options, to specify your LED, simply choose one option from each column. An example is shown below.

QRM	8	4	B	XX	HB	24A	E
SERIES	MOUNTING HOLE	TERMINALS	BEZEL FINISH	TYPE OF ILLUMINATION	LED COLOR	VOLTAGE	SEALING
QRM	8 = Ø8mm	4 = Pins 5 = Wires	B = Black Chrome	XX = Fixed light YY = Bi-color ZZ = Tri-color	R = Red G = Green Y = Yellow B = Blue W = White  HR = Hyper Bright Red HG = Hyper Bright Green HY = Hyper Bright Yellow  SR = Super Bright Red SG = Super Bright Green SY = Super Bright Yellow SB = Super Bright Blue SW = Super Bright White SO = Super Bright Orange  RG = Red/Green RY = Red/Yellow GY = Green/Yellow RYG = Red/Yellow/Green	02 = no resistor* 06 = 6VDC 12 = 12VDC 12A = 12VAC/DC 24 = 24VDC 24A = 24VAC/DC 28 = 28VDC 28A = 28VAC/DC	E = IP67 (Standard)

#### Example QRM84BXXHR24AE

Ø8mm mounting hole with pin terminations, black chrome finish, fixed light, Red 24VAC, panel sealed to IP67



- Standard wire length is 200mm, 24AWG UL1061, red wire denotes Anode (+), black wire denotes Cathode (-) for other wire lengths consult APEM
- For LEDs with alternate voltages consult APEM
- Bi-color LEDs, by connecting the gold Faston (+) one colour is produced, by reversing the supply voltage another colour is produced – Bi-colours are available up to 28VDC
- Take care when soldering (recommended solder temperature 270°C - 2 sec)
- The Tri-color LED has red and green LEDs when both are connected yellow is produced
- Standard Tri-color termination is two Anodes (+) and one Cathode (-)
- Tri-color wires are one red (+) and one green (+) Anode and one black (-) Cathode
- Tri-color pins are center (-) Cathode, shortest (+) Anode pin green, longest (+) Anode pin red
- Maximum panel thickness 3.5mm
- For multi-voltage options please consult APEM

\* = For resistorless versions (02) please refer to the forward voltage

# QRM-NV SERIES

Ø8mm (.315") Rear Panel Mount NVIS LED Indicators

---



## Distinctive features

Rear panel mount LED indicators with 5mm colored diffused epoxy lens with NVIS compatible filters for

- NVIS Green A
- NVIS Green B
- NVIS Yellow A
- NVIS Yellow B
- NVIS Red
- NVIS White

Black chrome finish.  
Voltage: 2VDC - 28VAC/DC  
Pins or 200mm long wires.  
IP67 sealing option (EN60529). Supplied with fixing nut and spring washer.

## Typical Applications

- Military
- Medical
- Telecommunications
- Engineering
- Transport Systems
- Special Vehicles
- Agricultural Vehicles

# QRM-NV SERIES

## NVIS Compatible Rear Panel Mounting LED Indicator

Distinctive features and specifications

### Features

- Ø8mm rear mounting LED indicator
- NVIS Green A, NVIS Green B, NVIS Yellow, NVIS Red, NVIS White
- High temperature NVG filters
- NVIS compliant to MIL Std 3009
- Black chrome finish
- 2VDC - 28VDC
- 200mm wire or rigid pin (1.00mm) terminations
- IP67 sealed (EN60529)
- Rear end epoxy sealed
- Supplied with fixing nut, spring washer and O-ring (Optional dress nuts available)



### TECHNICAL SPECIFICATIONS

Voltage	Operating Voltage (Min to Max)	Operating Current (Typical All Types)
02 (No Resistor)	2.1 to 3.3VDC	20mA max*
6VDC	5.4 to 6.6VDC	20mA
12VDC	10.8 to 13.2VDC	20mA
24VDC	21.6 to 26.4VDC	20mA
28VDC	25.2 to 30.8VDC	20mA

Max Reverse Voltage: 5V
Viewing Angle: 60°
Life Expectancy: 100,000 hours
Operating Temperature Range: -40 to +85°C
Storage Temperature Range: -55 to +100°C
Max panel thickness: 3.5mm
Torque: 60cNm

### Materials

<b>Body:</b> Black chrome plated brass	<b>Lock washer:</b> Spring steel
<b>Nut:</b> Black chrome plated brass	<b>Terminal seal:</b> Epoxy
<b>Panel seal:</b> Nitrile O-ring	<b>Wires:</b> 24AWG to UL1213

LED Color	NVIS Radiance	NVIS Chromaticity	Dominant Wavelength	MCD Output	Forward Voltage
NW1S Green A	$NR_A \leq 1.7eE-10 @ 0.1fL$	$r \leq .037$	530nm	150mcd	3.3V
NW1S Green A	$NR_A \leq 1.7eE-10 @ 0.1fL$	$r \leq .057$	555nm	150mcd	3.3V
NW1S Yellow Class A	$5.0E-8 \leq NR_A \leq 1.5E-7 @ 15fL$	$r \leq .083$	-	150mcd	3.3V
NW1S Yellow Class B	$4.7E-8 \leq NR_B \leq 1.47E-7 @ 15fL$	$r \leq 0.83$	585nm	150mcd	3.3V
NW1S Red	$4.7E-8 \leq NR_B \leq 1.4E-7 @ 15 fL$	$r \leq .060$	605nm	110mcd	2.1V
NW1S White	$NR_A \leq 1.0E-9 @ 0.1fL$	$r \leq .40$	(x).33 (y).33	150mcd	3.3V
Luminous intensity will be reduced with lower operating current.					

Note: The operating voltage must not be exceeded by more than 10% as this will result in reduced life expectancy.

The company reserves the right to change specifications without notice.

• Customer to supply resistor for desired operating current.

Luminous intensity is measured at 20mA on a discrete LED unless otherwise stated.

Luminous intensities and color shades of white LEDs may vary within a batch.

# QRM-NV SERIES

## NVIS Compatible Rear Panel Mounting LED Indicator

### Technical Drawings

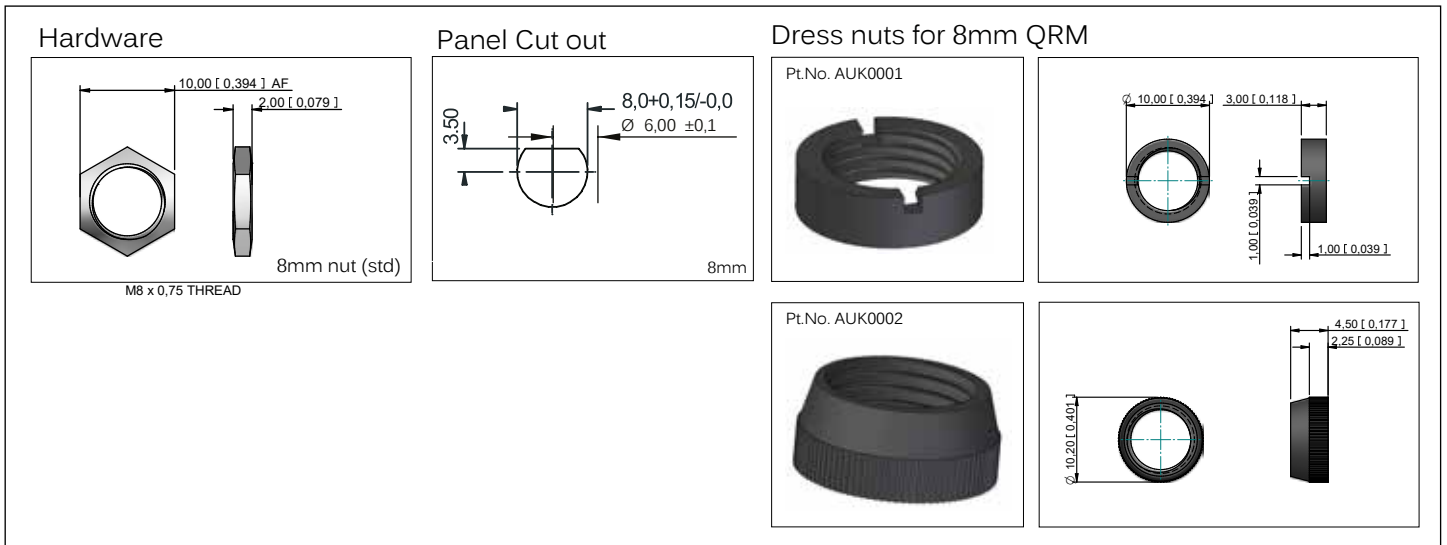
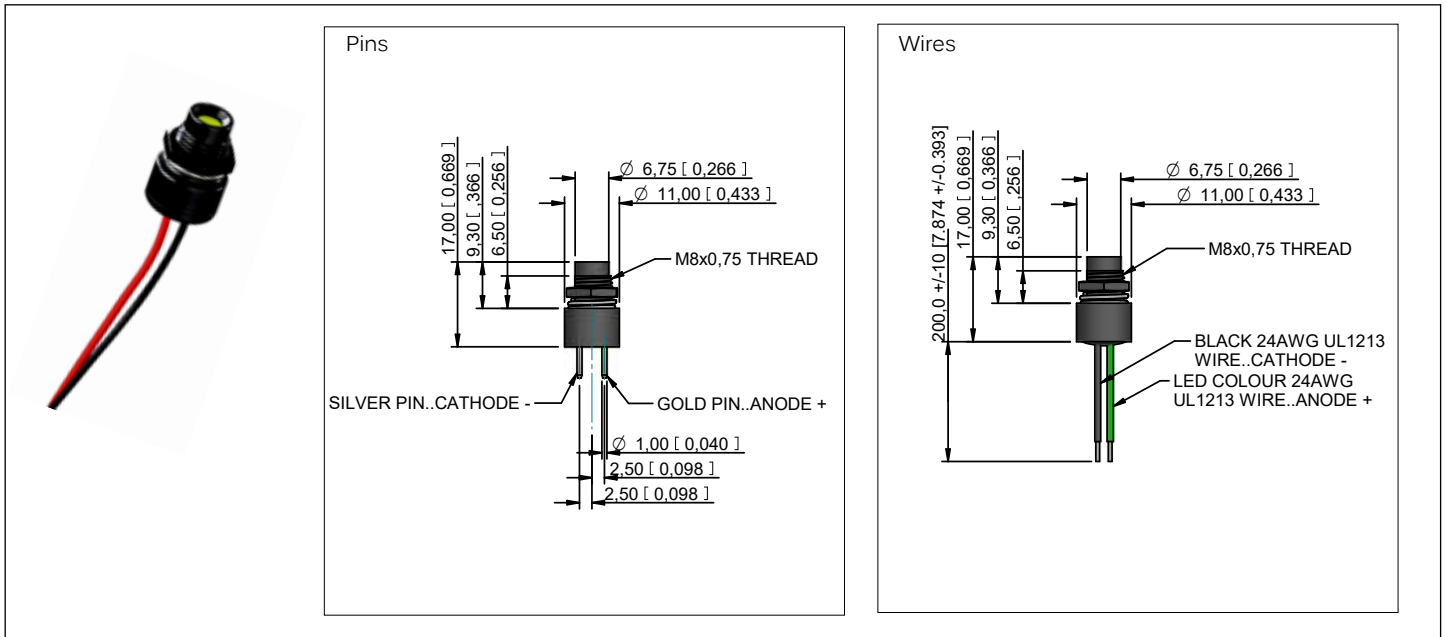

# QRM-NV SERIES

## NVIS Compatible Rear Panel Mounting LED Indicator

### Overview

#### STANDARD OPTIONS

The QRM Series is available with a range of standard options, to specify your LED, simply choose one option from each column. An example is shown below.

QRM-NV	8	5	B	XX	NV-GRA	24A	E
SERIES	MOUNTING HOLE	TERMINALS	BEZEL FINISH	TYPE OF ILLUMINATION	LED COLOR	VOLTAGE	SEALING
QRM-NV	8 = Ø8mm	4 = Ridgid Pins 5 = Wires	B = Black Chrome	XX = Fixed light	NV-GRA = NVIS Green A NV-GRB = NVIS Green B NV-YWA = NVIS Yellow A NV-YWB = NVIS Yellow B NV-RD = NVIS Red NV-WH = NVIS White	02 = no resistor* 06 = 6VDC 12 = 12VDC 12A = 12VAC/DC 24 = 24VDC 24A = 24VAC/DC 28 = 28VDC 28A = 28VAC/DC	E = IP67 (Standard)

#### Example QRM-NV85BXXNV-GRA24AE

Ø8mm mounting hole with wire terminations,  
black chrome finish, fixed light  
NVIS Green A 24V AC,  
panel sealed to IP67



- Standard wire length is 200mm, 24AWG UL1213, red wire denotes Anode (+), black wire denotes Cathode (-) for other wire lengths consult APEM
- For LEDs with alternate voltages consult APEM
- Take care when soldering (recommended solder temperature 270°C - 2 sec)
- Maximum panel thickness 3.5mm
- For resistorless versions (02) please pay attention to the forward voltage
- For multi-voltage options please consult Apem
- Suitable for the toughest enviroment and compliant to MIL standard specification

\* = For resistorless versions (02) please refer to the forward voltage



# QS SERIES

## Snap in Panel Mount LED Indicators

---



### Distinctive features

Snap in panel mount LED indicators with colored diffused flat lens, for typical replacement of filament and neon indicators.

- 6mm, 8mm, 10mm and 12mmØ cut-out sizes
- Front panel snap-in mounting requires no additional hardware
- Colored diffused flat lenses
- Available colours: Red, Green, Yellow, Blue, Orange, White (clear)
- Voltage range: 2VDC – 220VAC
- Terminations: solder lug/faston, 6mm (2.0 x 0.5mm), 8mm, 10mm, 12mm (2.8 x 0.8mm) or wires (200mm standard length)
- Standard intensity diffused LEDs or high brightness LEDs for daylight viewing
- Bi-color LED option
- UL496 recognised component

### Typical Applications

Domestic and Commercial white goods  
Catering Equipment  
Fire Alarm panels  
Power distribution sockets  
Battery chargers / Power supplies

# QS SERIES Snap-in Panel Mount LED Indicators

## Distinctive features and specifications

### Features

- 6mm, 8mm, 10mm and 12mm Ø cut-out sizes
- Front panel snap-in mounting requires no additional hardware
- Colored diffused flat lenses
- Red, Green, Yellow, Blue, Orange, White (clear)
- 2VDC – 220VAC
- 6mm solder lug (2.0x0.5mm) or 200mm wire terminations
- 8mm, 10mm, 12mm solder lug/Faston (2.8x0.8mm) or 200mm wire terminations
- Standard intensity diffused LED or high brightness LED for daylight viewing
- Bi-color and Tri-Color (8 and 10mm only) options

NB: UL Recognized Component



### TECHNICAL SPECIFICATIONS

Voltage	Operating Voltage (Min to Max)	Operating Current (Typical All Types)
02 (No Resistor)	1.8 to 2.5VDC	20mA max*
6VDC	5.4 to 6.6VDC	20mA
12VDC	10.8 to 13.2VDC	20mA
24VDC	21.6 to 26.4VDC	20mA
28VDC	25.2 to 30.8VDC	20mA
110VAC (not available on QS6)	99 to 110VAC	6mA
220VAC (not available on QS6)	207 to 253VAC	3mA

<b>Max Reverse Voltage:</b> 5V
<b>Viewing Angle:</b> 30–100° (dependant on model)
<b>Life Expectancy:</b> 100,000 hours
<b>Operating Temperature Range:</b> –40 to +85°C

Standard LED	6mm Intensity (all voltages)	8,10 & 12mm Intensity	Forward Voltage
HE Red	40mcd	100mcd	2.0V
Green	40mcd	60mcd	2.2V
Yellow	30mcd	50mcd	2.1V
Blue	1,200mcd	1600mcd	3.8V
White(clear)	1,200mcd	1600mcd	3.8V
Orange	60mcd	45mcd	2.0V
Bi-color (Typical) (Red/Green)	20/15mcd	30/12mcd	2.0V/2.2V
Tri-color (Typical) (Red/Green/Yellow)	-	60/15/13mcd	2.5V

Bi-color - The color is changed by reversing the polarity of the supply voltage.

Tri-color - The indicator has red and green LEDs, when both connected yellow is produced.

High Brightness	6mm Intensity (all voltages)	8,10 & 12mm Intensity	Forward Voltage
HE Red	3,700mcd	6,000mcd	2.2V
Green	2,000mcd	1,900mcd	3.2V
Yellow	1,200mcd	2,100mcd	2.0V
Orange	4,500mcd	4,500mcd	2.2V

Luminous intensity will be reduced with lower operating current.

Note: The operating voltage must not be exceeded by more than 10% as this will result in reduced life expectancy.

The company reserves the right to change specifications without notice.

\* Customer to supply resistor for desired operating current.

Luminous intensity is measured at 20mA on a discrete LED unless otherwise stated.

Luminous intensities and color shades of white LEDs may vary within a batch.

# QS SERIES Snap-in Panel Mount LED Indicators

## Technical Drawings

Ø6mm

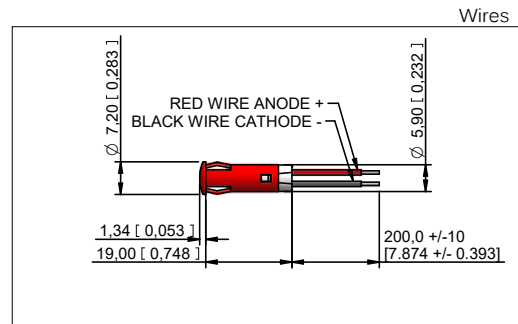
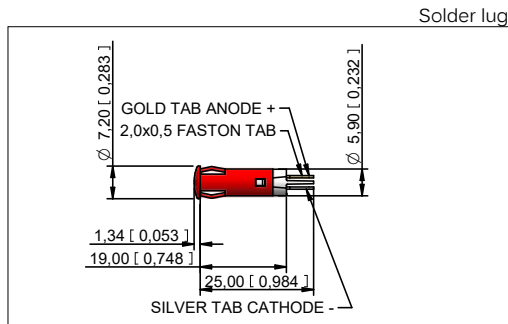

Ø8mm

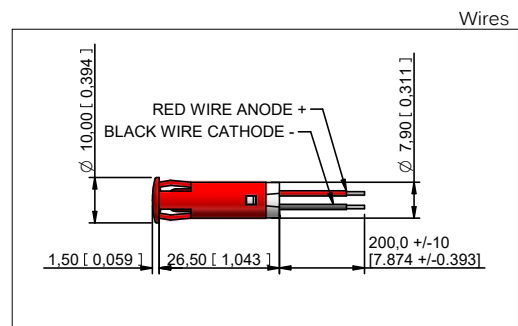
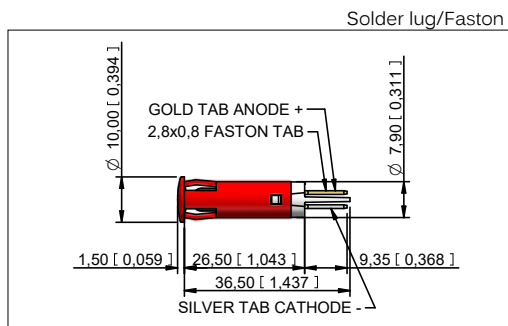

Ø10mm

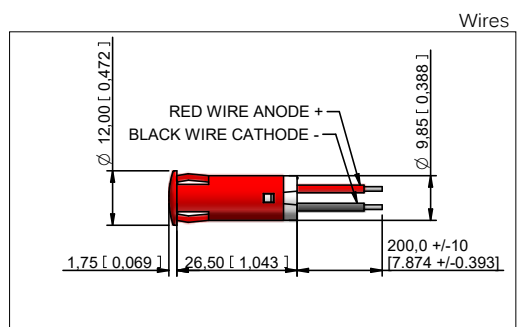
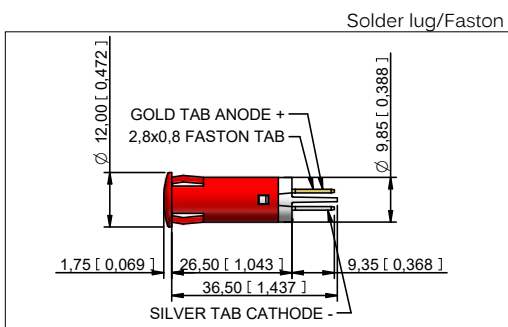

Ø12mm

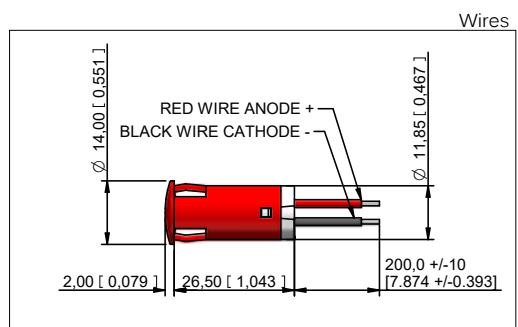
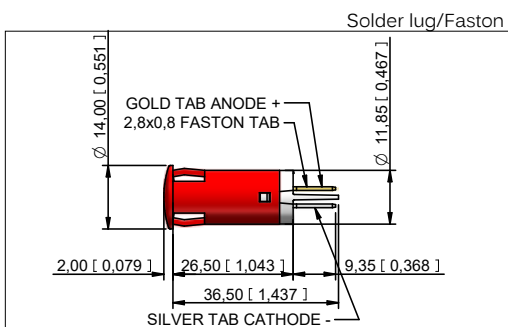

# QS SERIES Snap-in Panel Mount LED Indicators

## Order Overview

### STANDARD OPTIONS

The QS Series is available with a range of standard options, to specify your LED, simply choose one option from each column. An example is shown below.

QS	8	3	XX	R	220
SERIES	MOUNTING HOLE	TERMINALS	TYPE OF ILLUMINATION	LED COLOR	VOLTAGE
QS	6 = Ø6mm 8 = Ø8mm 10 = Ø10mm 12 = Ø12mm	1 = Solder lug/ faston 3 = Wires	XX = Fixed light YY = Bi-color ZZ = Tri-color (10mm only) KK = Flashing light (12 - 28VDC)	R = Red G = Green Y = Yellow B = Blue W = White (clear) O = Orange  HR = Hyper Bright Red HG = Hyper Bright Green HY = Hyper Bright Yellow HO = Hyper Bright Orange  RG = Red/Green  RYG = Red/Yellow/Green (10mm Only)	02 = no resistor* 06 = 6VDC 12 = 12VDC 24 = 24VDC 28 = 28VDC 110 = 110VAC 220 = 220VAC

**Example QS83XXR220**  
 Ø8mm mounting hole with wire terminations  
 fixed light, Red 220VAC



- Gold solder lug/Faston terminal denotes Anode (+), silver terminal denotes Cathode (-)
- Standard wire length is 200mm, QS6 & QS8 24AWG UL1061, QS10 & QS12 22AWG UL1061, red wire denotes Anode (+), black wire denotes Cathode (-) for other wire lengths consult APEM
- For LEDs with alternate voltages consult APEM
- Bi-color LEDs, by connecting the gold Faston (+) one color is produced, by reversing the supply voltage another color is produced – Bi-colors are available up to 28VDC
- Take care when soldering to the Faston terminals (recommended solder temperature 270°C - 2 sec)
- The Tri-color LED has red and green LEDs when both are connected yellow is produced
- Maximum panel thickness 11mm
- We recommend using high brightness LEDs for use at 220VAC
- For multi-voltage options please consult APEM

\* = For resistorless versions (02) please refer to the forward voltage

# Q SERIES

## Notations

---



**APEM**

## WORLDWIDE SALES & CUSTOMER SUPPORT

### AMERICAS



**USA**  
63 Neck Road  
HAVERHILL, MA 01835  
Tel: (+1) 978 372 1602  
Fax: (+1) 978 372 3534  
info@apem.com

**USA**  
970 Park Center Drive  
VISTA, CA 92081  
Tel: (+1) 760 598 2518  
Fax: (+1) 760 598 2524  
info@apem.com

### EMEA



**BENELUX**  
Avenue Excelsiorlaan 21  
1930 ZAVENTEM  
Belgium  
Tel B: (+32) 27 25 05 00  
Tel NL: (+31) (70) 799 91 51  
Fax: (+32) 27 25 22 00  
sales@apemswitches.be

**FRANCE**  
55, avenue Edouard Herriot  
BP1  
82303 CAUSSADE Cedex  
Tel: (+33) 5 63 93 14 98  
Fax: (+33) 5 63 93 19 03  
commercial@apem.fr

**GERMANY**  
Gewerbehof Giesing  
Paulsdorfferstr. 34, 2. OG  
D-81549 MUNICH  
Tel: (+49) 89 45 99 11 0  
Fax: (+49) 89 48 10 39  
info@apem.de

**ITALY**  
Via Marconi 147G  
12030 MARENE (CN)  
Tel: (+39) 0172 74 31 70  
Fax: (+39) 0172 74 31 71  
apem.italia@apem.it

**SWEDEN**  
Isafjordsgatan 35  
S-16440 KISTA  
Tel: (+46) 8 626 38 00  
Fax: (+46) 8 626 82 49  
info@apem.se

**UNITED KINGDOM**  
Drakes Drive  
LONG CRENDON, Bucks HP18 9BA  
England  
Tel: (+44) 1 844 202400  
Fax: (+44) 1 844 202500  
sales@apem.co.uk

**DENMARK**  
MEC  
Industriparken 23  
2750 BALLERUP  
Tel: (+45) 44 97 33 66  
Fax: (+45) 44 68 15 14  
danmec@mec.dk

### ASIAPAC



**CHINA**  
RongGuang Building, 602A  
11, Changshun Road  
200051 SHANGHAI  
Tel: (+86) 21 6278 8546,  
(+86) 21 6278 6872  
Fax: (+86) 21 6208 8209  
contact@apem.com.cn

**MORE THAN 130 DISTRIBUTORS WORLDWIDE**  
(Complete list available on [www.apem.com](http://www.apem.com))

[www.apem.com](http://www.apem.com)