

ADAME TECH



PRODUCT OVERVIEW 2025

About Adam Tech

Introduction and Promise

For 38 years it has been Adam Tech's continuing goal to offer one simple promise: We will provide you with the Highest Quality Product with the Best Service Available at the Lowest Possible Price.

Capabilities, Sales, Service, Manufacturing and Availability

We pride ourselves on the scope of our product offering which features a wide range of Connectivity Components & Cables, Electromechanical Products, Power & Protection Solutions, Switches, and Custom Solutions that reduce cost and improve performance in a broad range of applications. Our exclusive automated manufacturing processes provide consistent high quality with low cost and short lead times. We also welcome the opportunity to use our experience in providing custom solutions to your application specific product requirements. We can develop concepts into designs, tooling and production.

Adam Tech is a diversified manufacturer with locations and facilities spanning the globe. Its worldwide headquarters is in New Jersey, USA and its Asia headquarters is in New Taipei City, Taiwan. Both locations are fully staffed with sales and engineering support and offer complete warehousing capabilities. Across the Americas and EMEA, Adam Tech is represented by Business Development Managers and an extensive network of Independent Sales Representatives. Additionally, Adam Tech's valued distribution channel partners are present on six continents.

Over the past 38 years, Adam Tech has expanded its manufacturing and product development footprint across numerous countries and locations in China, Taiwan, Vietnam, Malaysia, and Thailand. The company believes that redundancy and diversification are essential to excellence and dependability, and it remains committed to these principles in pursuit of its goals.

Quality

It is our goal to exceed our customers' needs and expectations while delivering high quality products with the highest level of service possible. Our processes are controlled by multiple comprehensive quality management systems inclusive of Certified Quality Engineers (CQE's), Supplier Quality Engineers (SQE's), Product Quality Engineers (PQE's), Quality Systems Engineers (QE's), Product Quality Control, In Process Quality Control (IPQC), Final Quality Control (FQC), and Outgoing Quality Control. Medical Device manufacturing is controlled to ISO13485:16 & Automotive Products manufacturing controlled to IATF:16949.

Adam Tech strives to meet the following Quality Goals:

- Provide Defect-Free products and services
- Adhere to all applicable statutory, regulatory and customer requirements
- Leverage the constantly evolving manufacturing technologies to develop the best processes possible while maintaining the highest levels of service, quality and support.

Environmental

- Adam Tech's ISO14001:15 initiative puts an Environmental Management System in place which continually improves our environmental performance through the efficient use of resources and reduction of waste
- Additionally, Adam Tech fully complies with every major initiative in the restriction of hazardous materials in our products that impact the entire electronics industry, environment, and human health. We have taken strict measures to provide products that are lead-free and free from other hazardous materials. Adam Tech's products are all fully compliant to RoHS 3 Directive EU 2015/863 with no exemptions, China RoHS, China VOC, REACH Annex XVII, Deca BDE, Calif Prop 65, POP's, ODC's, Halogen Free and conflicting Mining & Metals. Restricted material beyond RoHS Adam Tech acknowledges Dodd Frank Act, and does not use Asbestos, rare earth metals or Red Phosphorus in any of our products.

Certifications



ISO 14001



ISO 45001



ISO 9001:2015



IATF 16949



ISO 13485



USB-IF



UL (AXUT2.E224052) - Attachment Plugs, Fuseless



UL (AYVZ2.E224050) - Attachment Plugs with Overload Protection



UL (BBTH2.E537617) - Intercell and Intertier Connectors for Use in Electrochemical Battery System Applications



UL (DUXR2.E224049) - Communications, Audio/Video, Data, and Other Signaling-Circuit Accessories



UL (ECBT2.E224053) - Connectors for Use in Data, Signal, Control, and Power Applications



UL (ECBT8.E224053) - Connectors for Use in Data, Signal, Control and Power Applications Certified for Canada



UL (ELBZ.E256360) - Cord Sets and Power Supply Cords



UL (ELBZ7.E256360) - Cord Sets and Power Supply Cords Certified for Canada



UL (FFVI2.E527051) - Electric Vehicle Plugs, Receptacles and Couplers - Component



UL (FOKR2.E547032) - Electromagnetic Interference Appliance Filters



UL (FOKY2.E224431) - Electromagnetic Interference Filters



UL (QQGQ2.E538449) - Power Supplies, Information Technology Equipment Including Electrical Business Equipment



UL (QQJQ2.E538449) - Power Supplies for Use with Audio/Video, Information and Communication Technology Equipment



UL (RFVW.E542871) - Electrical Quick Connect Terminals



UL (RFVW7.E542871) - Electrical Quick Connect Terminals for Canada



UL (RTRT2.E224051) - Receptacles for Plugs and Attachment Plugs



UL (RTRT8.E224051) - Receptacles for Plugs and Attachment Plugs Certified for Canada



UL (XCFR2.E333935) & UL (XCFR2.E498731) - Terminal Blocks



UL (XCFR8.E333935) & UL (XCFR8.E498731) - Terminal Blocks Certified for Canada



UL (ZMVV2.E542483) - Wire Connectors and Soldering Lugs



UL (ZMVV8.E542483) - Wire Connectors and Soldering Lugs Certified for Canada



UL (ZPFW2.E537685) - Wiring Harnesses



WOYR2.E520713 - Switches, Appliance and Special Use

Spring Loaded Connectors, Pins, Pads & Magnetic Assemblies

Adam Tech Spring Loaded Pins consist of a specially designed barrel and steel spring in either a discrete form or integrated into an insulator carrier/magnetic assembly. They are used in many industries across a wide range of applications to make a secure, high reliability connection. This series is highly customizable to meet specific stroke lengths, heights, and electrical capabilities. High-temp plastics are used for our insulators and unlimited molding designs allow for many different shapes and styles to be created for specific applications.

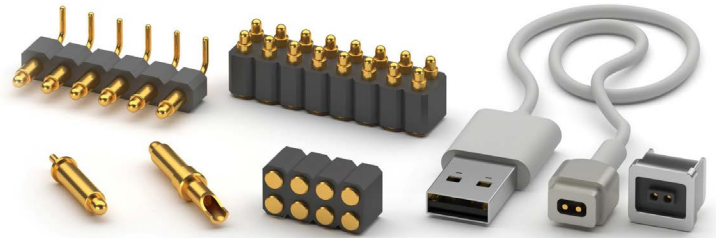

Modular Jacks & Plugs

Adam Tech MTJ series Modular Jacks are a complete line of PCB and wire leaded jacks which are UL and CSA approved and meet all required FCC rules and regulations. Adam Tech offers a multitude of sizes (4P2C thru 10P10C) with styles including single, ganged and stacked versions with options of ferrite or magnetic filtering and or metal shielding. Jacks with integral LED's and combination hybrids such as MTJ/USB jacks are also available. These jacks are available in thru-hole or SMT mounting.

SFP & QSFP

Adam Tech Small Form Factor connectors and cages are a popular interface for telecommunications and data communications applications. Our 20 position surface mount connector interfaces to both fiber optic and copper networking modules. Our cages are manufactured in single port and multiport configurations. All of our cages are available in both press fit and through hole mounting.

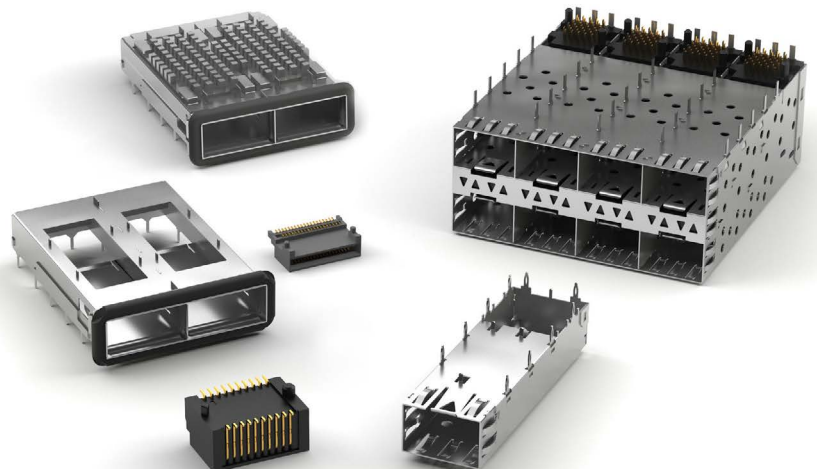

Click on category title to view full product listing.

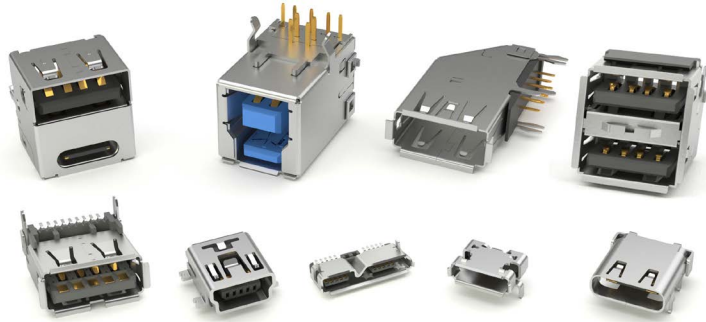

USB

USB, USB4, Mini USB, Micro USB and USB Type C 3.1 connectors are a complete line of shielded, hot pluggable, high speed I/O interface connectors available in a variety of body styles, sizes, positions and mounting orientations. Each is shielded for superior EMI/RFI protection and features spring contacts for exceptional connectivity properties. Specially designed shells with flares eliminate misconnection and kinked boardlocks add a strong, stable PCB attachment. For additional mating strength, HSecurLinC USB4, USB3.1, and Mini USB connectors and cables are equipped with a secure latch to ensure reliable connections. Adam Tech also offers a wide range of USB cable assemblies, including USB4, compatible with our line of connectors and available in various lengths.

HDMI

High Definition Multimedia Interface (HDMI) connectors and cable assemblies are a series of products that provide an uncompressed digital link between video and audio in a single digital interface connection. Typically they are used with digital versatile (DVD) players, digital televisions (DVI), set top boxes and other audio/visual devices to consolidate interfaces and eliminate multiple cable assemblies. HDMI connectors are small, easy to use interconnects that can carry up to 5 Gbps of combined video and audio in a single connector/cable.

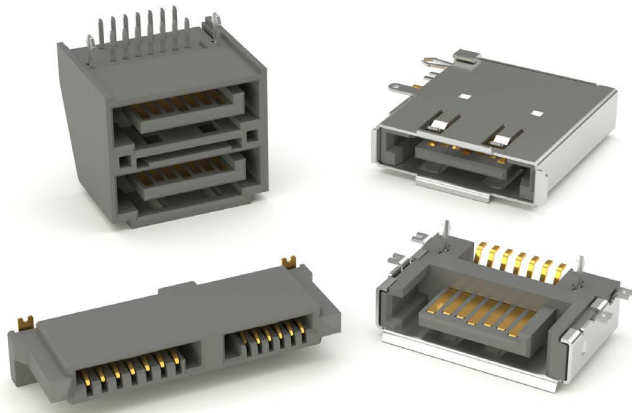
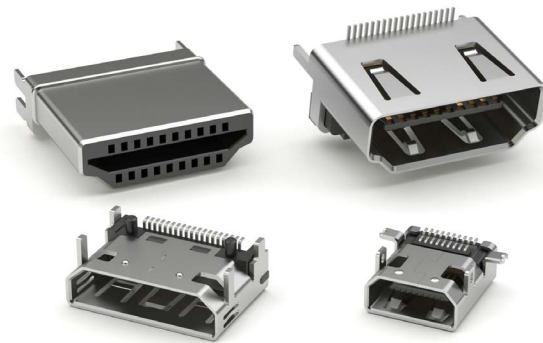

SATA Connectors

Adam Tech SATA and eSATA series Serial ATA connectors combine hot-plug capability with a combination of power and signal contacts in a blind-mate design. They are ideal for connecting disc drives to backplanes in servers or network equipment. Adam Tech SATA connectors are designed with differential-pair signaling technology and are precision manufactured to consistently perform at speeds up to 3.0 Gbits/s.

DisplayPort

Adam Tech DisplayPort series is a new high band width digital interface connection designed to provide true digital imaging while providing a multitude of colors and crystal clear sound through one small plug which can also supply power. There are four main links, one auxiliary channel and one hot-plug signal line. Adam Tech DisplayPort connectors are designed to work on a broad array of devices, including printers, televisions, camcorders, cameras, and DVD players. Our DisplayPort connectors are fully compatible with industry standards and are backwards compatible to VGA, DVI & HDMI.



Click on category title to view full product listing.

D-Sub Connectors

D-Subminiature connectors are available in each industry configuration including 9, 15, 25, 37, and 50 positions. A broad range of mounting styles and contact types are included within our D-Sub series including, but not limited to, Right Angle, Vertical, Slimline, and other body types. Contacts are precision stamped or machined for high reliability applications.

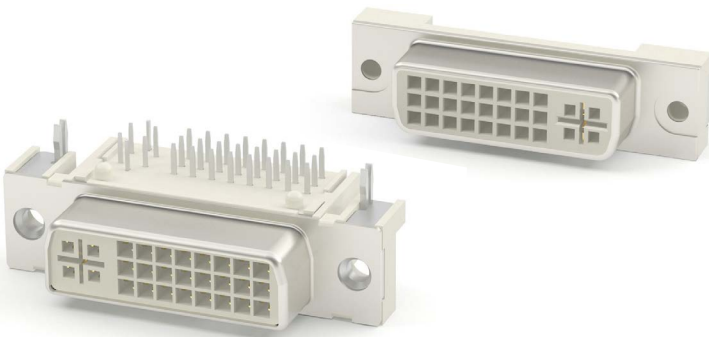
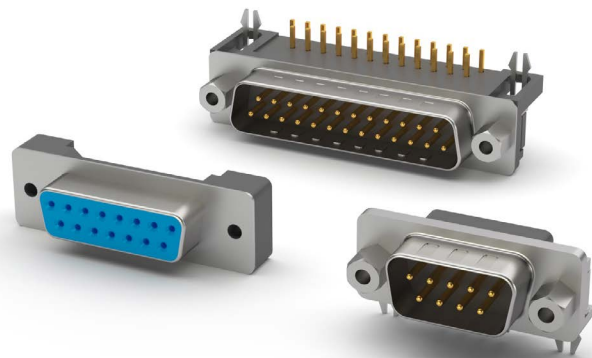

DVI Connectors

Adam Tech DVI series Digital Visual Interface connectors are the standard digital interface for flat panels, video graphics cards, monitors and HDTV units. This series includes DVI-D (Digital), DVI-A (Analog) and DVI-I (Integrated Digital/Audio). Their unique crossing ground blades provide high speed performance at low cost. Available in Straight or Right Angle PCB mount receptacles, each version also features our specially designed contacts which improve signal performance and a zinc alloy shield that reduces electromagnetic interference (EMI).

FAKRA Connectors

Adam Tech FAKRA Connectors (Fachkreis Automobil, a German standard) are SMB based automotive-grade connectors that can operate up to 6 GHz. These connectors are embedded within a special color-code plastic housing that contain a locking feature with an audible clicking noise which confirms the connection. We offer our FAKRA series in Standard, High Speed Data (HSD) and Mini styles. Each style comes with a range of configurability options to choose the appropriate keying for your application.



HT-X

Adam Tech's HT-X series consists of high speed modular twisted-pair data connectors and cable assemblies. These products are capable of data speed rates up to 56 Gbps, with a DC frequency range up to 20 GHz. Their compact size makes them ideal for applications with limited space, such as in the automotive industry. Each plug and cable jack has color-coded housings, equipped with a locking mechanism, ensuring secure connections while avoiding mismatings.

Click on category title to view full product listing.



RF Connectors

Adam Tech's RF connector series are a comprehensive assortment of Radio Frequency Signal Connectors in standard, miniature, subminiature, micro miniature, and surface mount styles. Included are BNC, TNC, FME, FMA, SMA, SMB, N, F, PAL, UHF, Mini UHF, MCX, MMCX, MHF, W.FL, & 1.6/5.6 coupling versions. Each has a standard industry interface. Most are ideal for applications where size and weight are important in densely populated applications. All afford excellent RF characteristics.

RF Cable Assemblies & Antennas

Adam Tech RF Assemblies are available in a wide range of industry styles and types including IPEX, SMA, MCX, and BNC. They are available in numerous lengths, which may also be customized to your requirements. Our antennas follow industry leading trends and currently include 3G Embedded, WLAN External, GPS, LTE Embedded, WiFi, and other styles. RF cables are highly customizable and can be tailored to suit your application requirements.



Circular Industrial Connectors - Waterproof, Ruggedized & High Current

Adam Tech's Waterproof Connector series is a broad range of M Style, Circular, and RJ45/USB mated sets with IP ratings ranging from IP66 – IP68. These connectors are offered in different pin counts and keying styles and can be used in many applications.

Fiber Optic Adapters

Adam Tech's Fiber Optic Adapters properly align the individual fibers of two patch cables during the mating process, ensuring reliable connections in optical communication systems. These adapters enable multiple devices to communicate simultaneously. Adam Tech's broad offering includes APC, FC, LC, MPO, PC, and SC adapters. Simplex, duplex, 4-plex, and 8-plex adapters are available to connect various quantities of fibers.

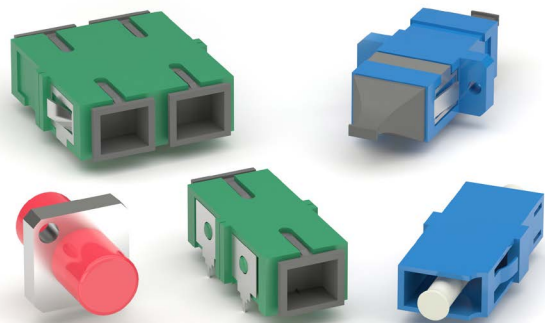

Click on category title to view full product listing.

Memory Connectors & Sockets

Adam Tech's Memory Connector Series is a complete range of memory sockets for most memory card applications including Compact Flash, PCMCIA, Memory Stick and Secure Digital. Our advanced designs are focused on their ease of use, mating accuracy, card retention and life cycle. Precision engineered, extremely durable mating contacts and PCB leads contribute to a solid, high reliability, long life design.

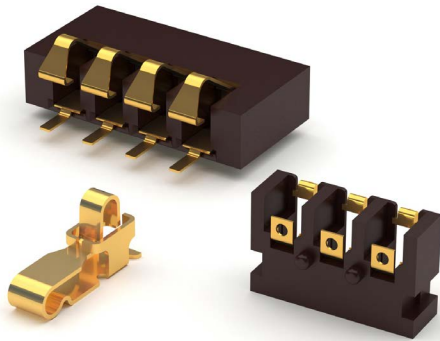
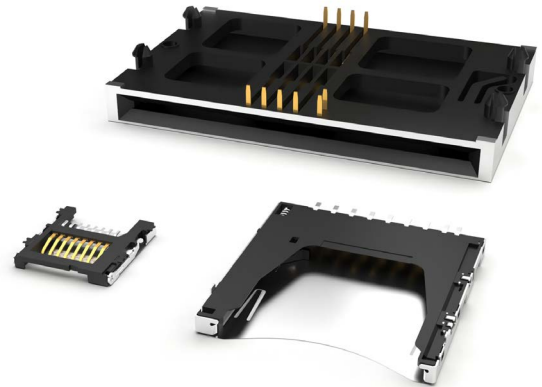

Spring Connectors & Battery Systems

Adam Tech Spring Connectors, Battery Holders, Battery Snaps and Mobile Battery Connectors are designed to create connections and contain batteries in electronic equipment. This series includes battery holders and coin cell holders for AAA, AA, C, D, 9V and lithium coin cells. Adam Tech produces this series in a variety of terminations such as through hole PCB leads, SMT leads, wire leads and solder lugs. Custom lead lengths on wire configurations are also available.

Flex Circuit Connectors

Adam Tech Flexible Flat Cable (FFC) connectors are ZIF (zero insertion force) and LIF (low insertion force) connectors designed to provide a reliable method of connecting flexible printed circuits to a PCB. LIF connectors are available in .020", .039", .049" and .100" centerline spacing and ZIF styles are available in .012", .020", .031", .039" and .049" centerline spacing. Both offer single and dual sided versions, in thru-hole or SMT mounting, and in vertical or horizontal orientation.

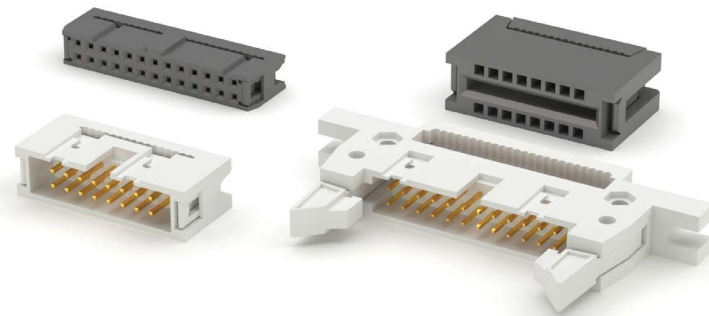
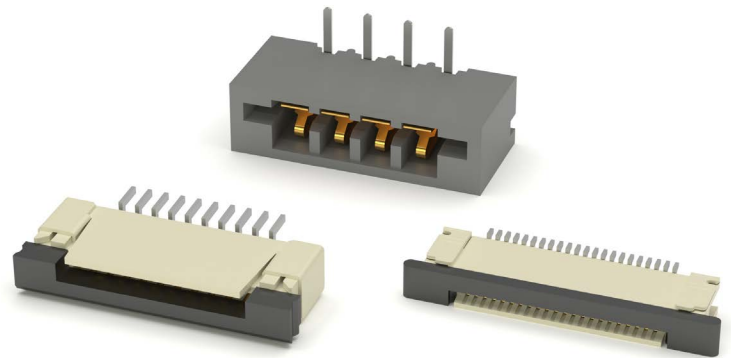

IDC Connectors

Insulation displacement termination connectors (IDC) are designed to terminate flat cable quickly and effectively in a wide variety of applications. These connectors are available in .050", .079" and .100" centerline spacing. The IDC termination style has migrated and been implemented into a wide range of connector styles because of its reliability and ease of use.

Click on category title to view full product listing.

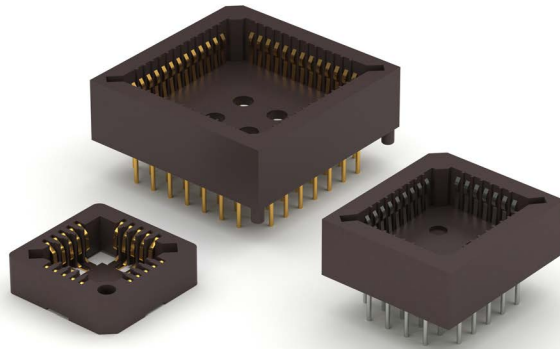

PLCC Chip Carrier Sockets

Adam Tech SMT PLCC Series Sockets are low profile, thin wall sockets designed to convert plastic leaded chips to a thru-hole PCB format on a .100" centerline grid. They conform to JEDEC MS 106 and MS 018 pin count standards. Adam Tech's superior precision stamped contact design provides consistent, high retention contacts for all size chips. Chip exchanges or replacements are easily made with Adam Tech's chip remover part number PLCC-EXT.

IC Sockets

Adam Tech ICS Series IC Sockets are a low profile design available in single or dual row in .100" centerline pin spacing with .300" or .600" row spacing. Our ISD Series are fine pitched sockets on 0.070" centerlines with .300" or .600" row spacing. All Adam Tech sockets are manufactured with our exclusive single beam dual wipe contact design which produces a high pressure wiping action for superior connectivity. In addition to an internal contact stop which prevents over stressing of the contact, each has a wide lead in to eliminate mis-mating and a closed bottom anti-solder wicking design.

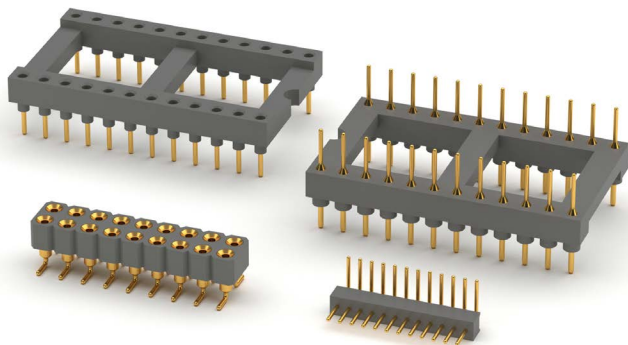
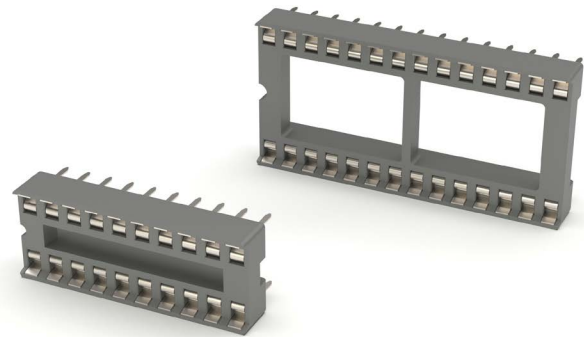

Machined Sockets & Headers

Machine Pin Sockets and Terminal Strips offer a full range of exceptional quality, high reliability DIP and SIP package Sockets and Terminal Strips. These sockets feature solid, precision turned sleeves with a closed bottom design to eliminate flux intrusion and solder wicking during soldering. The stamped spring copper insert provides an excellent connection and allows repeated insertion and withdrawals. Sockets are available in single or dual row in .039", .050", .078" and .100" centerline pin spacing with .300", .400" or .600" row spacing. Plating options include choice of gold, tin or selective gold plating. Our insulators are molded of UL94V-0 thermoplastic and both Sockets and Terminal Strips are XY stackable.

Board to Board & High Speed Board to Board

Adam Tech manufactures a wide range of application specific board stacking connectors which were designed and built to specific customer requirements. Our experienced staff has developed custom products in a variety of contact styles and stacking heights. Available pitches include .016", .020", .025", .031", .039" centerlines. Many designs are produced using automated manufacturing processes to increase reliability and provide significant cost savings.

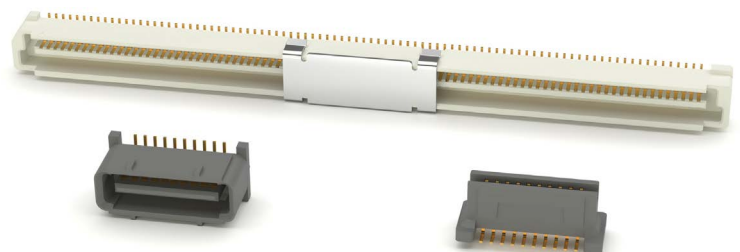

Click on category title to view full product listing.

DC Power Jacks & Plugs

DC Power Jacks are a complete line of miniature and sub-miniature power jacks primarily used for the transmission of wall current transformed to DC power for detached and hand held instruments. DC Power Jacks are manufactured with a variety of center pin sizes for all standard applications including 1.00mm, 1.30mm, 2.00mm and 2.50mm. Our contact is designed using a wide spring grade plated copper alloy for exceptional plug retention and low contact resistance.

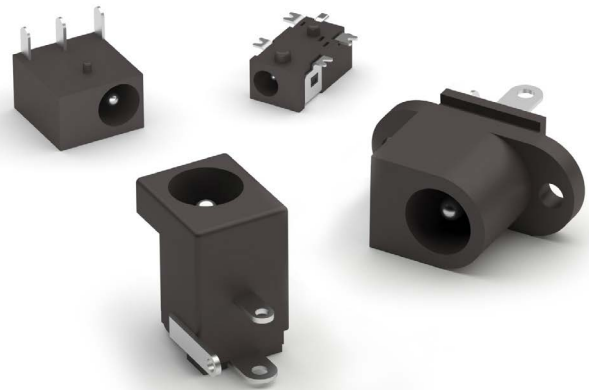
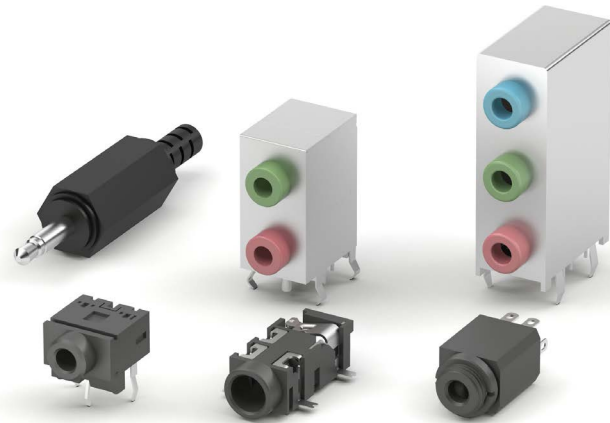

Audio Jacks & Plugs

Adam Tech ASJ Series Stereo Jacks are a broad range of 2.5 and 3.5mm jacks used primarily in computer and multi-media audio applications. This series provides a multitude of sizes and configurations that are available in single or multiple switching forms. Options include choice of plastic or metal reinforced bodies, single, stacked and ganged versions or color-coded jacks for port identification.

Waterproof Audio & DC Power Jacks

Adam Tech's Waterproof I/O & DC Charging connectors are a combination of IP67 and Splash Proof sealed designs intended for use in applications exposed to moisture, humidity and rain. Special seals, o-rings, and epoxy coatings are incorporated into this product line to achieve the listed ratings. Adam Tech offers full customization capabilities to waterproof body styles not seen in this catalog. Reach out to us today with your requirement and our team of design engineers will work hand in hand with you to create the solution you need.

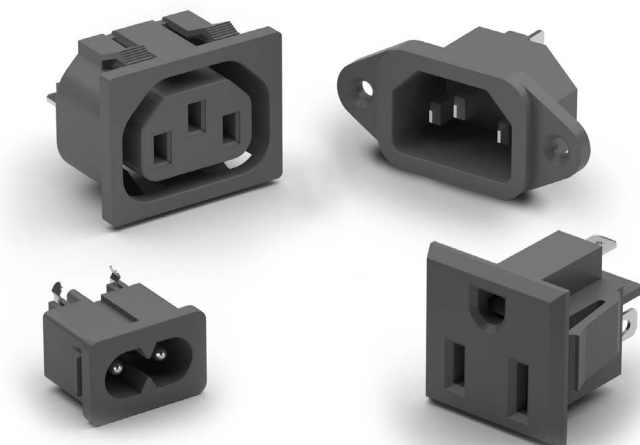

AC Inlets & Outlets

Adam Tech IEC & Mini IEC series AC Inlets and Outlets are primary power receptacles designed, manufactured, tested and approved to UL, CSA, VDE and other applicable international specifications including IEC-60320 and CEE-22. Adam Tech offers a wide variety of body styles, shapes and orientations to accommodate most class I & II applications with two or three blade contacts in both IEC and Mini IEC configurations. Mounting choices include screw holes, snap-in versions, and four termination styles. Options of ganged ports or receptacles with integral fuse holders are also available.

Click on category title to view full product listing.

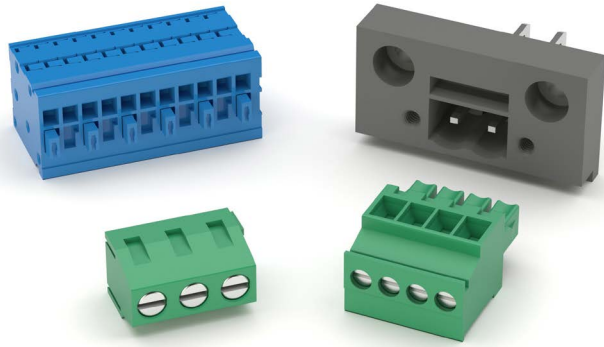

Euro Blocks

Adam Tech EB Series Euro Blocks are a broad range of PCB mounted blocks in various sizes and profiles with pitches of 2.50mm, 2.54mm, 3.50mm, 3.81mm, 3.96mm, 5.00mm, 5.08mm, 6.35mm, 7.50mm, 7.62mm, 9.25mm, 9.50mm, 10.00mm, 10.16mm, 12.50mm, 12.70mm and 15.00mm. Included are types that have wire entry from Top, Side, or Side Angle. Two piece 'pluggable' versions and 'Lever Actuated' styles are also available. Each contains a unique wire guard design and is precision manufactured for smooth operation and ease of use.

Terminal Blocks & Europa Strips

Terminal Blocks (also known as Barrier Blocks) & Europa Strips are a full range of Blocks which are most commonly used to terminate wires and eliminate splicing. They are offered in sixteen different centerlines from .250" to .630" with open or closed back options. Each is available for bulkhead or PCB mounting with choice of Straight or Right Angle PCB Terminals, Clip-tite and/or Turret Terminals. This series is manufactured from flexible thermoplastic and resists cracking and breaking. They are manufactured from Hi-Temp plastics and have current carrying capability up to 30 Amps.

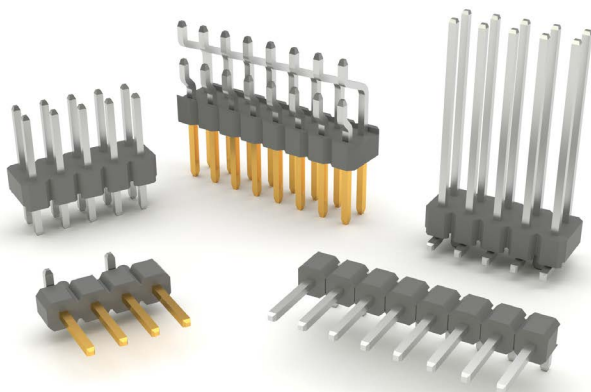

Pin Headers

Pin Headers are a full range of headers in a variety of configurations including Single, Dual and Three rows, Straight or Right Angle in Thru-Hole or SMT mounting. Available pitches include .050", .079" and .100" centerline. Their posts are smoothly finished and taper tipped to eliminate insertion damage to the PCB or mating connector. Pin Headers can be easily cut into exact sizes as required. Options include stacked insulator versions and choice of tin, gold or selective gold plating.

Shunts

Mini Shunts are available in .050", .079", .100" and .200" centerlines. They quickly and easily jump individual pins on pin headers to perform manual programming on PCB's. This series offers a broad range of sizes, shapes and colors. Shunts are designed with detents at top for easy fingertip installation removal. Options include integrated pull tabs and gang types which are molded in one piece. This series is extremely low cost and is a highly economical, cost effective solution for replacing PCB switches. They are available in Gold or Tin plating.

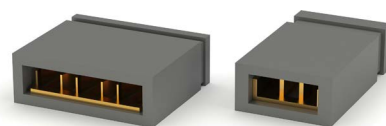

Click on category title to view full product listing.

Wire to Board & Wire to Wire Connectors and Systems

Adam Tech's Wire to Board & Wire to Wire connectors and systems are available in different terminations and sizes intended for use on a variety of applications. These connectors provide power and signal with different body styles, termination options, and centerlines.

Wire to Board Power

Adam Tech Wire to Board Power Connectors consist of a receptacle and plug set in a variety of single and multiple row configurations with .098", .100", .118", .137", .163", .165", .224" and .250" pitch centerlines. They are manufactured of Nylon 6/6 with a flammability rating of UL94V-2 or UL94V-0. This series is designed as a mated set with a PCB mounted header and a wire mounted socket which securely latches to header when mated. Our specially designed bodies provide polarization to eliminate mismatching and our latching system resists heavy vibration. PCB mounted headers have molded pegs which align and brace the PCB tails for trouble free assembly and use.

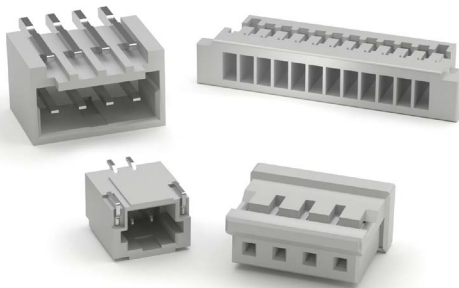
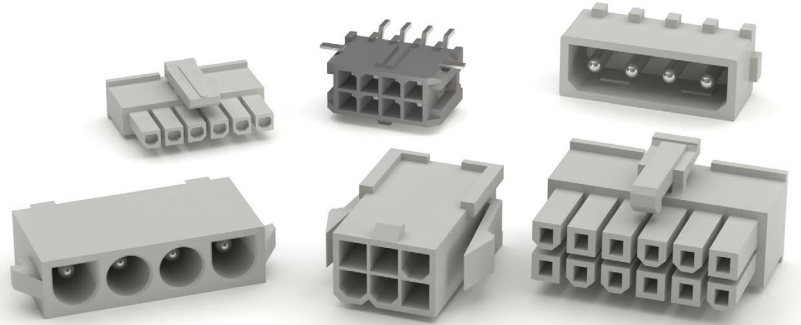

Miniature Disconnecting Wire to Board

Adam Tech multiple pitch Headers and Housings are a matched set of Crimp Wire Housings and PCB mounted Shrouded Headers available in Straight, Right Angle or SMT orientation. Available pitches are .031", .039", .047", .049", .059", .079" and .098" centerlines. Offered in various popular industry standard styles they provide a lightweight, fine pitched, polarized, high reliability connection system.

Crimp Contacts

Adam Tech crimp contacts are designed for a variety of wire gauge options and insert smoothly into our Wire to Wire & Wire to Board housing components. Our crimp contacts are precision stamped and offered in a variety of plating options with different thicknesses to suit nearly any applicational requirement. Our design team is also able to offer complete turnkey services to design a new crimp contact to customer specifications.

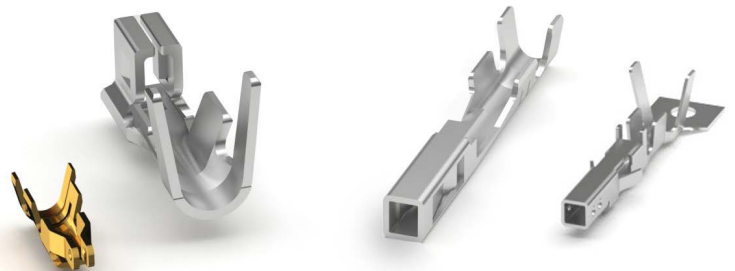

Click on category title to view full product listing.

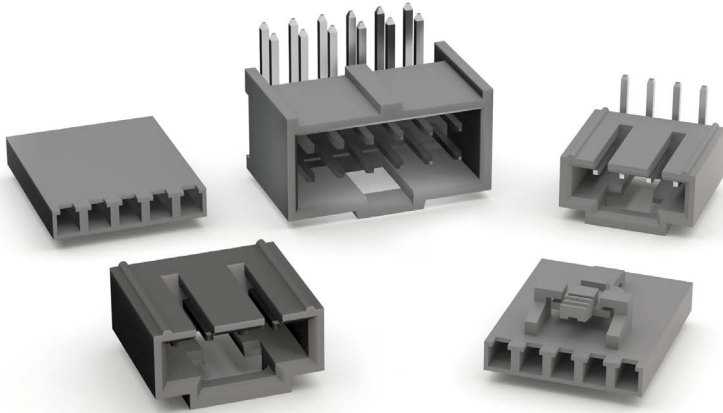

Disconnecting Wire to Board

Adam Tech Disconnecting Wire to Board series is a combination of various wire housings, board headers, and crimp terminals. The styles include Latching Types with .098", .100", .156" and .200" centerline, IDC termination styles with .100" & .156" centerlines, and locking designs with friction ramps for secure fits.

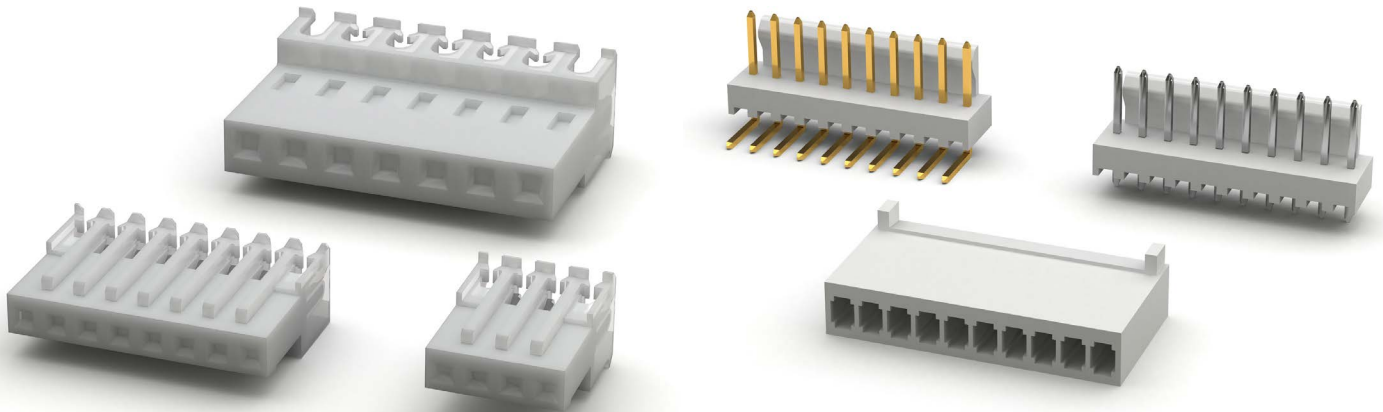

Wire to Wire Power

Adam Tech Wire to Wire Power connectors are sets of wire mounted plugs and receptacles with crimp contacts. These sets mate with locking clips or latches for a secure fit. They are suited for a range of wire types and gauges and provide a reliable easy-mate connection. Available Centerlines are .098", .118", .145", .177", .198", .250" and .264" for nearly any application. UL94V-2 or UL04V-0 plastics are used to satisfy flammability requirements.

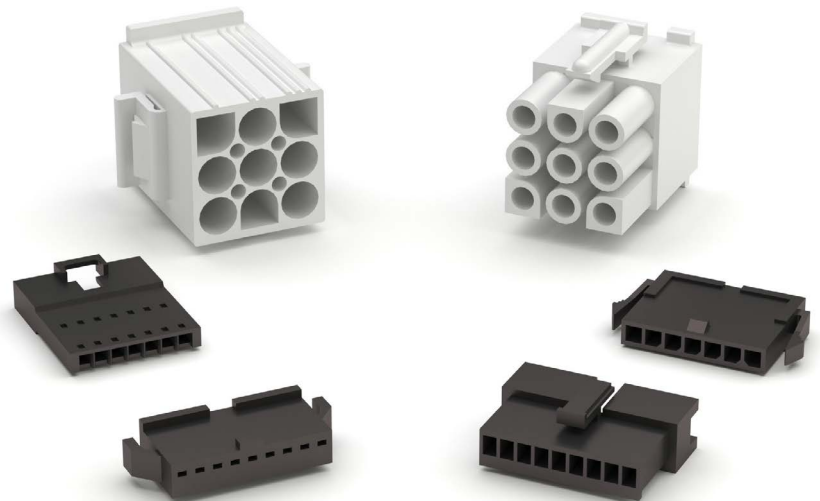

Click on category title to view full product listing.

Shrouded & Latching Headers

Adam Tech Shrouded and Latching Headers are a dual row shrouded header for use with dual row IDC female socket connectors. Our low profile, space saving design has a center slot for the socket's polarization bump. Adam Tech's Box Headers are available in Straight PCB Mount, Right Angle PCB Mount and SMT Mounting. Available pitches are .050", .079" and .100" centerlines. Plating options include choice of Gold, Tin or Selective Gold. SMT versions are manufactured with a Hi-Temp insulator. Additional options include latches and custom pin lengths.

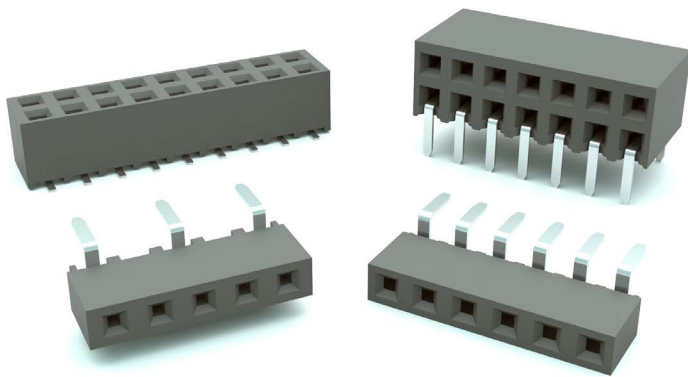
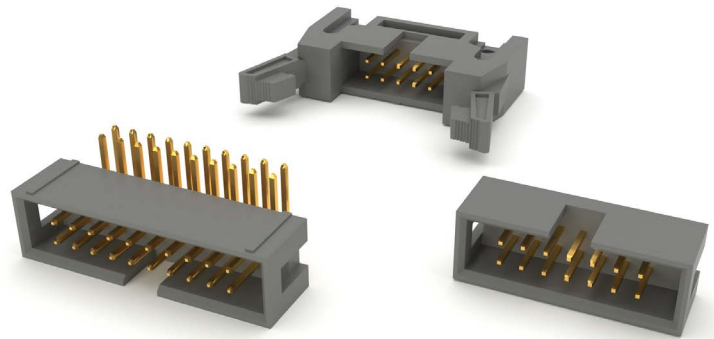

Receptacle Strips

Receptacle Strips are a series of sockets offered in a multitude of sizes and profiles designed to satisfy most socket requirements and a range of mounting orientations. Available pitches are .050", .079" and .100" centerlines. Each type has a specially designed contact system which uses a wiping mating action and produces a high normal force connection with gold, tin or selective gold plating. All are available with Standard or Hi-Temp Thermoplastic insulators.

Mini Flex Connectors

Adam Tech's Mini-Flex series of connectors includes cable to board, wire to board and board to board choices. This .050" pitch series is designed with a dual contact point mating system and an array of locating posts and PCB pegs for positive alignment and friction lock mating. Rigid, staggered solder tails provide excellent stability for rugged use and feature kinked tails for PCB retention.

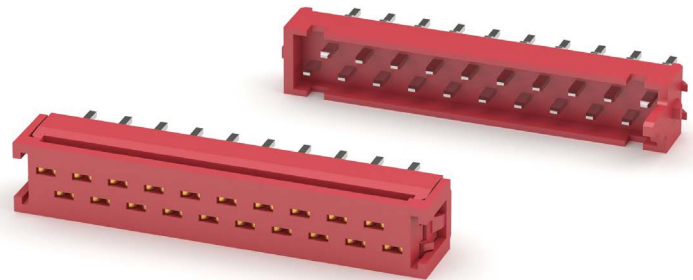

Circular DIN Connectors & Plugs

Adam Tech Circular, Power, and Mini DIN Jacks continue to be a popular, high density, low cost, low profile interconnect solution. Available in a multitude of styles and configurations, they are able to satisfy a broad range of applications. This series offers jacks in 3 thru 9 positions with straight, right angle or panel mounting, in addition to the choice of four different shielding and panel grounding options. Color-coded jacks for port identification are also available. Adam Tech's special contact design offers a high reliability connection with extremely low contact resistance.

[Click on category title to view full product listing.](#)

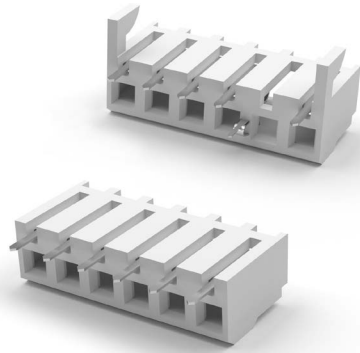

Receptacles with Board Hooks

Adam Tech PCE & PCD Series receptacles are .100" pitch centerline PCB mounted sockets that have integral PC Board hooks which wrap around the edge of the PCB for added stability. They are made with three mounting and mating configurations which include Top, Bottom & Side entry.

Automotive Connectors

Automotive Connectors manufactured in our TS-16949 (IATF) certified facility are state of the art solutions to connect a variety of Automotive applications. This specialized series of Automotive board headers and pin strips achieve suitability for a wide range of applications. Our success with automotive connectors and cables is heavily "Custom Solution Based." The bulk of Adam Tech's Automotive expertise is centered around developing custom Automotive solutions not available elsewhere on the market. Many of our customers will submit to us a sketch of a specialized auto connector that requires design and tooling. Our team of engineers will develop a custom design tailored specifically to your application. For more details, submit a "Custom Solution" request through our Website Inquiry Form.

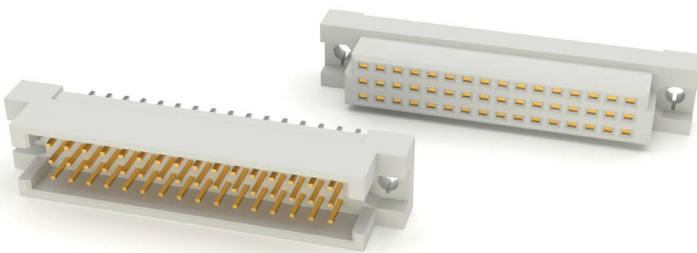

DIN 41612 Connectors

Adam Tech DIN 41612 Connectors are a versatile two piece PCB connector set with features useful for many applications including connections for plug-in card and back-panel wiring, PCB to PCB attachment and peripheral connections for external interfaces. Features include a multitude of body sizes and styles with options that include selective contact loading, make and break contacts, contact lead length choices and contact plating variations each in .100" [2.54mm] or .200" [5.08mm] centerline spacing.

Card Edge Connectors

Adam Tech CE Series Card Edge Connectors are precision engineered PCB mount connectors developed to mate with the plated fingers of a printed circuit daughter board. Their bifurcated, cantilever contacts are set in a dual readout configuration and they offer a reliable connection for a wide range of PCB thicknesses. Adam Tech's sturdy solder tails with tapers allow easy insertion and rugged durability.

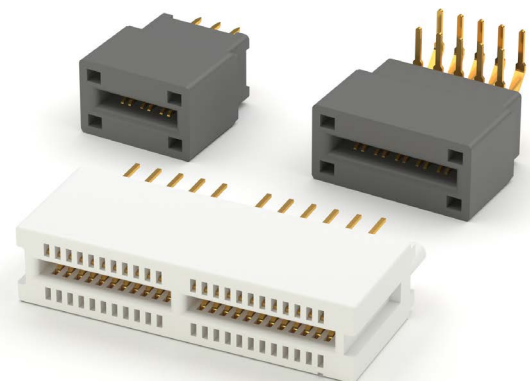

Click on category title to view full product listing.

Flat Flex Cable Assemblies

Adam Tech Flat Flex Cables (FFC) are available in a wide variety of options including 0.50mm – 2mm centerline spacing, nearly any length or contact number required, and configurability of contacts location on same side, alternate sides, or a combination of both.

Our FFC series is fully customizable with regard to any of the features above including also the ability to specify exactly which contacts (terminals) you require for your application. Reach out to us today to get started on your design.



Fuse Holders

Adam Tech Fuseholders are fully enclosed in Hi Temp thermoplastic with integrated .250" Male Quick Connect terminals on either side. The unique plastic enclosure offers a stacking side mount option to integrate a series of fuseholders side by side. Available in 0.50, 3, and 6 Amp options, Adam Tech fuseholders are an efficient option for protecting your application.

Switches

Available in Toggle, Rocker, Keylock & Pushbutton styles, switches can be integrated into a wide range of market applications. Our switches product line is designed to integrate seamlessly with many of our electronic connector components to offer a full solution for your application.

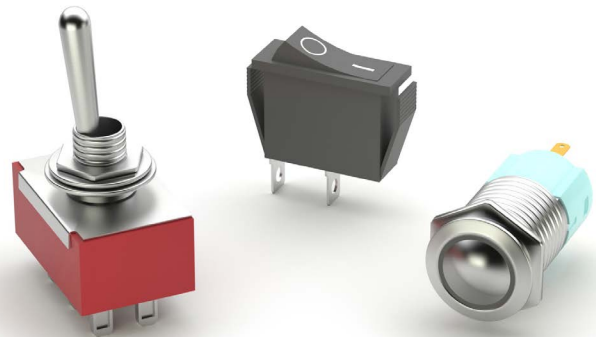

Click on category title to view full product listing.



Line Cord Couplers & Keystone Jacks

Adam Tech Line Cord Couplers and Keystone Jacks are available in industry standard housing sizes of 6 and 8 positions. We offer shielded and non-shielded options, both of which are suitable for a wide range of applications. Our keystone jacks support speeds up to Cat5E and CAT6.

Wired Leaded Jacks

Adam Tech MTJP Series Wire Leaded Handset and Panel Jacks are conveniently prepared with wire leads ready for final assembly. This series has a multitude of housing shapes to fit many specific applications. They are offered in 4, 6, & 8 positions with choice of Stripped and Tinned leads or leads with Spade Terminals. Adam Tech jacks are UL and CSA approved and meet all required FCC rules and regulations.

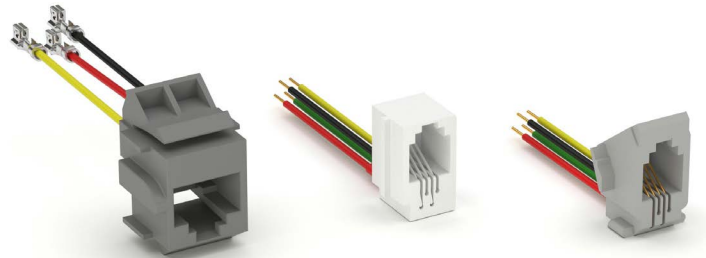

I/O Cable Assemblies

Adam Tech standard cable assemblies provide system designers with a comprehensive assortment of cable solutions for both power and signal applications in the telecom, datacom, industrial, healthcare and consumer industries. Our product offering includes USB, USB with latches, HDMI, D-Sub, VGA, DVI, DisplayPort, Power Cords & Cat5e, Cat6, Cat6a, Cat7 and Cat7a

Electric Vehicle Chargers

Adam Tech's EV Charger Cables provide a durable and efficient solution to electric vehicle charging. Both Type 1 and Type 2 plugs are available to meet multiple EV charging needs. Equipped with cable lengths of 3 and 5 meters, vehicles can be charged from a variety of distances. All Adam Tech EV chargers are TUV safety approved. NACS chargers are also available, offering some of the fastest speeds in the industry, and compatible with top Electric Vehicle brands. Adam Tech is committed to providing reliable and cost effective charging solutions to the growing electric vehicle industry



Click on category title to view full product listing.

Push Pull Connectors

Adam Tech's comprehensive line of Push Pull Connectors consists of metal and plastic connectors, elbow sockets, and bend reliefs. Each product type is offered in a variety of options, including positions, mounting, and size. Specialty waterproof push pull connectors are also available with ratings of IP67 and IP68. Adam Tech Push Pull Connectors are ideal for any application requiring easy, secure connections.



Power Line Filters

Adam Tech's EMI/RFI Power Line Filters are designed to suppress or eliminate incoming electromagnetic interference of high-frequency signals and noise. This allows devices to run without interruption. This broad product line offers voltage ratings of 115/250VAC for standard versions, and 440/520VAC or 520/760VAC for high power versions. Current ratings range all the way from 1A to 2500A. A variety of options are available, including mounting, termination, fuses, and switches.

Transceivers

Adam Tech's Fiber Optic Transceivers transmit and receive data with speed and reliability. This diverse product line includes SFP, SFP+, SFP28, QSFP+, and QSFP28 pluggable modules. With data rates ranging from 1.25G to 100G and transmissions between 10km and 100m, a wide range of applications are covered. Most of the offering is composed of single fiber bidirectional transceivers, whose paired A and B parts transmit and receive in two different directions of the center wavelength to cooperatively achieve bi-directional transmission of optical signals on a fiber.



Click on category title to view full product listing.

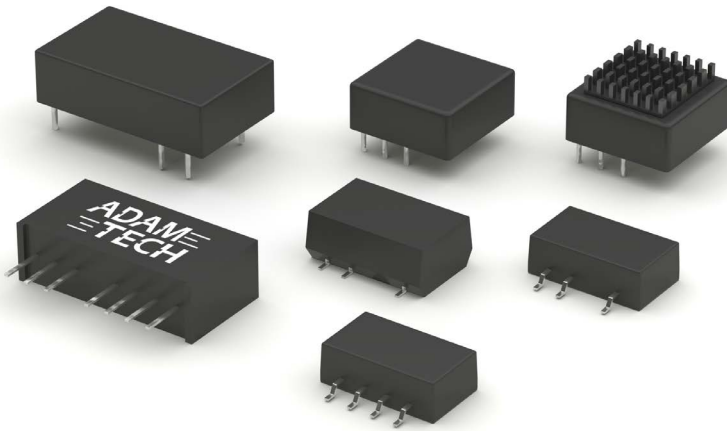

DIN Rail Terminal Blocks

Adam Tech's REB Series DIN Rail Terminal Blocks are ideal for connecting conductors safely and reliably to DIN Rails. The series consists of feed-through terminal blocks offered in different configurations. Each configuration is available in a variety of options, including terminal width, wire gauge, and color. Compatible covers/caps are also available, providing additional insulation to protect the terminal blocks from damage.

Power Converters

Adam Tech's offering consists of both DC-DC and AC-DC Converters. DC-DC Converters convert direct current from one voltage level to another. While AC-DC Converters convert alternating current into direct current. These products are ideal for applications that utilize the cooperation of different voltage levels and electric currents. This product line is equipped to accommodate these various applications, supporting a wide range of watts, voltages, and currents. In addition, Adam Tech possesses the ability to manufacture custom converters to meet every customer's needs.

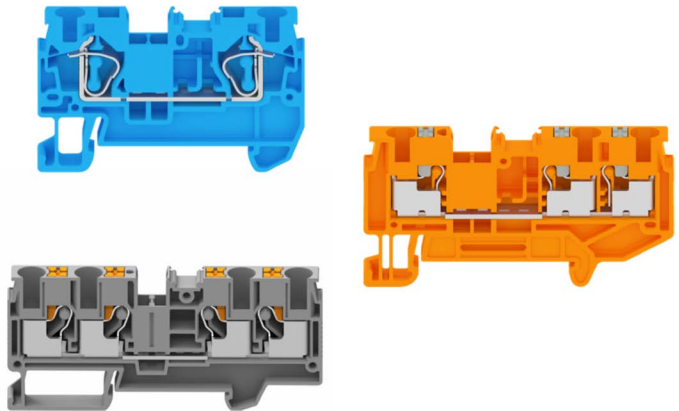

Energy Storage Connectors

Adam Tech's ESF/ESM Series Energy Storage Connectors provide a critical link between battery modules. This link ensures safe and reliable connections in energy storage systems, such as electric vehicle charging, renewable energy devices, and both industrial and consumer energy storage. The series is composed of various mated pairs, offered in both orange and black. Various voltage ratings, current ratings, and wire gauges are supported, making this series compatible with a wide range of applications.

Cable Accessories (Heat Shrink Tubing, Cable Glands & Hand Tools)

Adam Tech's vast line of cable assemblies is further enhanced with a wide offering of accessories. IP68 plastic and metal cable glands headline this series, with their ability to effectively seal and connect cables to a device. There is also an expansive offering of Heat Shrink Tubing, which includes standard, dual wall, high voltage, and medical grade. An RF crimp tool kit is available, equipped with a ratchet crimper, cable cutter, cable stripper and full die set. Lastly, there are various hand tools available, compatible with a wide range of products



Terminals & Stampings

Adam Tech's Terminals and Stampings are suitable for use in a wide range of applications. The offering is composed of quick disconnect, receptacle cluster, and spade terminals, as well as a variety of stampings. Various terminal widths and wire gauges are supported, accompanied by options such as termination, insulation, and plating.

Board Level Heat Sinks

Adam Tech's Board Level Heat Sinks ensure optimal device performance by efficiently dissipating heat generated by components on a device's PCB (printed circuit boards). Composed of aluminum, a highly thermally conductive material, they effectively transfer heat by radiating it into the air, cooling the device. Their large, finned surface area enhances airflow for natural convection heat dissipation, making them ideal for applications requiring temperature regulation. Their lightweight, compact design makes them perfect for applications with limited space, and suitable for common TO-220, TO-247 and SOT-32 component packages. With customizable options and easy installation methods, Adam Tech's board level heat sinks offer a cost-effective solution for improving thermal performance in various electronic devices.

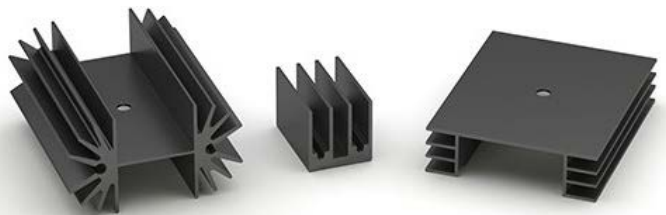

Secur-Seal Wire-to-Wire Connectors

Adam Tech's Secur-Seal Wire-to-Wire Connectors provide sealed waterproof protection to a variety of harsh environment applications. This series is composed of securely latched connector housings ranging from two to six positions, various AWG terminal sets, and wire seals. They provide sealed IP67 waterproof protection and accommodate various current ratings and wire gauge ranges. Their compact size further enhances their application compatibility. Custom connector and cable assembly options are welcomed.

Custom Connectors, Moldings & Stampings

Adam Tech can provide custom solutions from concept through to production. Adam Tech utilizes over 30 years of experience to create high quality and reliable Application Specific Interconnect Solutions.

Request A Quote

Send your requirements to info@adam-tech.com and let our experienced team of design engineers create and propose a solution for you. We offer "complete capability" service which includes in-house engineering, component manufacturing, assembly & technical sales support.

Custom Connector, Moldings & Stampings Process

Step #1: Modifying an Existing Design or Starting from Scratch?

First, tell us if you have an existing Adam Tech part number (or competitor part number) that you would like to modify.

Modifying an Existing Part

Mark up any drawings you have with changes you would like to make.

Our design engineering team will engage with you to offer constructive feedback and begin the design process.

Design a New Part

Provide us with any preliminary drawings or sketches that you have completed yourself.

If you have not completed any preliminary design then please advise us of this and we'll begin the design for you ourselves with any suggestions.

Step #2: Design Creation Through Collaboration

Based on the sketch or explanation given to us, we'll prepare a preliminary drawing for your review.

During this process we'll refine the details to arrive at a final design.

Once the design is settled, we'll prepare a final 2D and 3d model along with a quote.

Step #3: Presentation of Final 2D and 3D Models

Once the final 2D and 3D models are complete - we'll send them to you for review. The model should be imported into your application software for final verification before signing the 2D drawing to initiate tooling.

Step #4: Begin Building Tooling

After acceptance of the quote and models, it's time to begin the tooling process. Depending on the type of product, this may include building molds, dies, and assembly machines or equipment.

Adam Tech can usually provide options for Manual Assembly OR Automated Assembly (capable of higher capacity rates).

At the beginning of the tooling process we can provide for you a Gantt Chart of the schedule and finish date so you can follow along.

Custom Cable Assemblies

Adam Tech manufactures a wide selection of quality custom cable assemblies to exact customer specifications using UL approved wire and cable. Our production lines utilize the most updated equipment and processes to provide our customers with the highest level of quality and reliability.

Custom Assembly Process

Step #1: Modifying an Existing Design or Starting from Scratch?

First, tell us if you have an existing Adam Tech part number (or competitor part number) that you would like to modify.

Modifying an Existing Cable Assembly

Mark up any drawings you have with changes you would like to make.

Our design engineering team will engage with you to offer constructive feedback and begin the design process.

Design a New Cable Assembly

Provide us with any preliminary drawings or sketches that you have completed yourself.

If you have not completed any preliminary design then please advise us of this and we'll begin the design for you ourselves with any suggestions.

Step #2: Drawing Presentation & Approval

Based on the sketch or explanation given to us, we'll prepare a preliminary drawing for your review.

During this process we'll refine the details to arrive at a final design.

Once the design is settled, we'll prepare a final 2D and quote.

Custom Options

Magnetic Pogo Pin Cable Assemblies:

Full line of magnetic pogo pin cable assemblies and mating connectors.

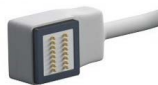

Automotive Wire Harnessing:

IATF 16949 (TS) Certified.



- HDMI
- DVI & SVGA
- DisplayPort
- USB
- D-Sub
- OBD II

Harsh Environment:

M8/M12, Circular, and USB/Ethernet cables and connector sets with sealed IP ratings.



RF and Antenna Cable Assemblies:

Including BNC, SMA, SMB, UHF, Mini UHF, MCX, MMCX, and more.

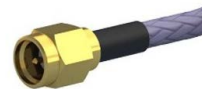

- Network
- Flat Ribbon
- Discrete Wire
- Patch Cord
- Power
- Digital

Cable Assemblies

Adam Tech manufactures a wide range of standard and custom cable assemblies, such as the various types displayed and listed below. The offering is suitable for a variety of markets and applications, thanks to its inclusion of weatherproof, ruggedized, and IP rated cable assemblies. Every assembly is produced with the highest level of quality and reliability to support our customers' needs.



Flex Jumper



M8 & M12

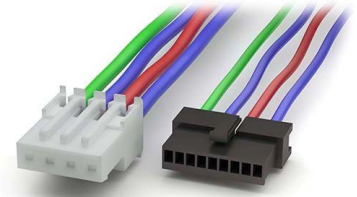

Wire to Board



RF



Wire to Wire



D-Subminiature



HDMI



RJ45



USB

Additional Available Assemblies

- HT-X
- FAKRA
- Flat Flex (FFC)
- DVI & SVGA
- DisplayPort
- Sensor
- EV/NACS
- OBD II
- Network
- Fiber Optic
- Power
- Digital



To contact us, scan the QR
code to reach our website
inquiry form.

adam-tech.com